

MUN4

IMPORTANT

This book is invariably to be kept under lock and key when not in use, and it is not to be taken outside the Establishment without the express permission of the Commanding Officer.

C. 6540.

O. U. 5267.

AMMUNITION
POCKET BOOK

1924.

GEELONG

DEC 29 1926 (To be kept inside the cover of O.U. 5267 after the necessary notations have been made in the book.)

No

This book is invariably to be kept locked up when not in use and is not to be taken outside the ship or establishment for which it is issued without the express permission of the Commanding Officer.

TECHNICAL LIBRARY
AMMUNITION FACTORY

228
NON/ACC.
O.U. 5267 (1).

623.45(02)/AD
(1926).

ADDENDUM No. 1 GREAT BRITAIN

TO

O.U. 5267.

AMMUNITION POCKET BOOK, 1924.

1926.

A note "See Addendum" should be inserted in the margin of O.U. 5267 against the paragraphs affected by this Addendum, and the words "with Addendum No. 1" inserted after O.U. 5267 on the outside of the cover.

ADMIRALTY, S.W.

GUNNERY BRANCH.

(G. 12364/26. September, 1926)

FOR OFFICIAL USE ONLY.

This book is the property of H.M. Government.

Its contents are not to be communicated either directly or indirectly to the Press, or to any person not holding an official position in H.M. Service.

FOR OFFICIAL USE ONLY.

Attention is called to the penalties attaching to any infraction
of the Official Secrets Acts.

ADDENDUM No. 1
TO
AMMUNITION POCKET BOOK, 1924.

The following amendments have been approved and are to be embodied in "O.U. 5267, Ammunition Pocket Book, 1924" :—

Page 20. Paragraph—"Future supplies of B.L. Cartridges, etc." :—

Line 9. "Lot number of Cordite," *add* "and sub-lot numbers if allocated."

After line 13, *add* "The word 'FOIL' if applicable."

Page 21. *Delete* lines 4 to 12 inclusive.

Pages 21 and 22. *Markings on Cases for B.L. Charges.*

Delete line 7 to end of paragraph and *insert*—"The following markings are stencilled on the cases :—

- (a) Number of charges in the case.
- (b) Fraction denoting fraction of full charge.
- (c) The designation and mark of the cartridge.
- (d) The word "FOIL" where applicable.
- (e) Nature, size and lot number of the cordite, the figures of the lot number being in as large type as possible. When sub-lot numbers are allocated, the sub-lot number will be stencilled after the lot number.
- (f) The word "FILLED"; monogram of filling station; and date of filling.
- (g) The letters "EXD"; monogram of examining station; and date as applicable.
- (h) The words—
 " For practice only,"
 " For Gunnery Schools only,"
 as applicable.
- (i) The words "REDUCED CHARGES" on all four sides of rectangular cases as applicable.
- (j) The marking "12 IN." on the lid of "L" cases containing 12-in. charges.
- (k) The words "REDUCED PRACTICE" when the case contains the under-mentioned charges :—

B.L. 4 in. Mk. IX—IX***, 4 lb. 4 oz., M.D.11,
Practice.

B.L. 4 in. Mk. VII, 6 lb. 9 oz., MD. 16, Practice.

A raised metal star on the lid indicates charges for Star shell only.

The letter "N" is stencilled where it is not already cut, branded or cast on the case.

Cases which have been inspected by the Inspecting Officers are stencilled INS instead of EXD.

REP^d and REP^{kd} on the sides of a cylindrical case denotes that it contains cartridges which have been repaired and put into a new case. The above abbreviations would be followed by the initials of the filling station and the date when the case was refilled.

REMADE.—This denotes that the case contains cartridges which have been broken down and remade using a new cartridge bag. The above would be followed by the initials of the remaking station and date."

Page 23. Paragraph commencing "A new method of sealing boxes"

Delete paragraph and three succeeding paragraphs.

Page 35. Line 4 from bottom. Amend to read :—

"of Q.F. Cartridges, 12 pdr., 13 pdr., 3 in. and above (Fig. 2)."

Page 36. After line 4 add :—

8. The word "FOIL" if applicable.

9. The number of the "G" letter authorising the design, if the charge is made up to a sketch design for use in Gunnery School firings only.

Page 37. At top of page insert note :—

NOTE.—2, 3 and 6 Pdr. Cartridges made up at Home Depots will have these markings placed on the side of the case, using the silver nitrate method of stencilling.

Pages 39 and 40. Delete Section. "Markings on the lids of Q.F. Ammunition Boxes," paragraphs 1 to 34 inclusive.

Insert :—

"The following marks are stencilled on the boxes :—

All Boxes containing Q.F. Cartridges.

The letter "N" (where this is not already cut, cast or branded on the box).

Boxes containing Q.F. Cartridges, 12 pdr. and above.

(Separate loading.)

- (i) Number of cartridges in the box and the words "CARTRIDGES, Q.F."
- (ii) Designation and mark of the cartridge.
- (iii) The word "FOIL" when applicable.
- (iv) Nature, size and lot number of the cordite. When sub-lot numbers are allocated the sub-lot number is stencilled after the lot number in lettering similar to that used for the lot number.
- (v) The words "FILLED," monogram of filling station and date of filling.

- (vi) The words "EXD," monogram of examining station and date, as applicable.
- (vii) The word "CASES," manufacturer's initials, and the year of manufacture. If the box contains repaired cases, the year of manufacture and REPD is stencilled when they are all of the same make and year of manufacture.
- (viii) The words "IGNITERS METAL MARK" where applicable.
- (ix) The words "CYL CORDITE" and lot numbers of cylinders where applicable.
- (x) The word "ADAPTER" and mark of adapter where applicable.
- (xi) The words "PRIMER No. . . . Mark" and name and maker and filler, with maker and filler's lot number or date where applicable.
- (xii) The words "FOR GUNNERY SCHOOLS" on two opposite sides of the box, if it contains charges for use in Gunnery Schools only.
- (xiii) The letters "M.R.," one on each side of one of the raised metal stars, if the cases have milled rims.
- (xiv) The words "CHARGES ONLY" on two opposite sides of the box, if it contains Q.F. charges of the B.I. type.
- (xv) The letters or words "D.E.M.S.," "TRAWLERS," etc. on the top and all four sides, if the box contains cartridges made up with cartridge cases specially allocated for such services.

"Boxes containing Q.F. Cartridges above 6 pdr."

(Fixed Ammunition.)

- (xvi) The number of cartridges in the box and the words "CARTRIDGES Q.F."
- (xvii) The designation and mark of the cartridge.
- (xviii) The word "FOIL" when applicable.
- (xix) The nature, size and lot number of the cordite. When sub-lot numbers are allocated the sub-lot number is stencilled after the lot number in similar lettering.
- (xx) The word "FILLED," monogram of filling station and date of filling.
- (xxi) The letters "EXD," monogram of examining station and date as applicable.
- (xxii) The word "CASES," manufacturer's initials and date. If the box contains repaired cases, the year of manufacture and "REPD" is stencilled when the cases are all of the same make and year of manufacture.
- (xxiii) The word "PRIMERS" with number and mark, name of maker and filler, and maker and filler's lot number, or date where applicable.

- (xxiv) The nature of the projectile with the word "FUZED" or "PLUGGED" as applicable.
- (xxv) The word "FUZES," with the nature, mark, lot number, name of maker, date of filling and number of gaine as applicable.
- (xxvi) The words "FOR GUNNERY SCHOOLS" on two opposite sides, if the box contains charges for use in Gunnery Schools only.
- (xxvii) The letters "M.R." one on each side of one of the raised metal stars, if the cases have milled rims.
- (xxviii) The symbol \hat{T} , if the shell is fitted with a night tracer.
- (xxix) The symbol \sim if the shell is designed for, but not fitted with a night tracer.
- (xxx) The words "16 L B SHELL" when applicable.
- (xxxi) The letters or words "D.E.M.S.," "TRAWLERS," etc., on the top and all four sides, if the box contains cartridges made up with cartridge cases specially allocated for such services.
- (xxxii) The words "CLIPS, No." when the box contains ammunition for Q.F., 4 in., Marks V-V* guns."
 - "Boxes containing Q.F. Cartridges, 6 Pdr., and below."*
- (xxxiii) The number of cartridges in the box and the words "CARTRIDGES Q.F."
- (xxxiv) The designation and mark of the cartridges.
- (xxxv) The nature, size and lot number of the Cordite. When sub-lot numbers are allocated, the sub-lot number in lettering similar to that used for the lot number.
- (xxxvi) The word "FILLED," monogram of filling station and date of filling.
- (xxxvii) The letters "EXD," monogram of examining station and date as applicable.
- (xxxviii) The word "CASES" with manufacturer's initials and date. The letters "REPD," if the box contains repaired cases, with the manufacturer's initials and date, if the cases are all of the same mark and date.
- (xxxix) The word "PRIMERS," with nature and mark; name of maker and filler, with maker and filler's lot number, or date, or the word "CAPS Mk" when applicable.
 - (xl) The nature of the projectile, with the words "FUZED" or "PLUGGED" as applicable.
 - (xli) The word "FUZES" with the nature, mark, lot number, name of maker and date of filling.
 - (xlii) The words "FOR GUNNERY SCHOOLS ONLY" on two opposite sides, if the box contains cartridges made up with cases specially sentenced for such use.
 - (xliii) The words "NOT FOR USE WITH SUB-CALIBRE GUNS," if the box contains cartridges made up with Mark III 6 pdr. or Mark IV 3 pdr. practice shot.

- (xliv) The letter "A," if the box contains 3 and 6 pdr. cartridges made up with annealed shell.
- (xlv) The word "BELTS NO.", if the box contains belted ammunition.
- (xlvi) The words "SUB-CALIBRE MARK II GUN" on both ends of the box, when it contains 2 pdr. ammunition for Mark II, sub-calibre guns."

NOTE.—All boxes which have been inspected by the Inspecting Officers are stencilled "INS" instead of "EXD."

Pages 40 and 41. Paragraph headed "The following may be found on the side of the box," *delete* clauses 2, 4 and lines 6 to 10 inclusive on p. 41.

Insert new paragraph. "Boxes containing star shell charges have raised brass stars (one on metal cases, two on wood boxes) on their lids to facilitate recognition at night."

Page 41. *Delete* paragraph "Labels."

Insert—"Labelling."

"Each case or box containing ammunition carries :—

- (a) The composite label denoting Government explosives and classification of explosive. This label is fixed in any convenient position, but clear of any stencilling or stamping, and of the junction of the lid and body.
- (b) Two station monogram labels affixed with shellac so as to form a seal. These labels (except for cylindrical cases provided with sealing tapes) are placed over the junction of the lid and body, one at each of opposite sides of the lid.

Cylindrical cases which are provided with sealing tapes are to have these labels placed over the ends of the tapes, junction of lid and locking ring.

- (c) In addition, boxes containing Q.F. ammunition have two labels showing the contents, one affixed on the side of the package and one inside the lid."

Page 41. *Delete* last 12 lines on page.

Page 42. *Delete*.

Page 57. Line 13 from bottom. *Delete* from "In these latter" to end of page. *Substitute* new paragraph—

"All L & M cases have a set screw in each end ring which can be screwed home to prevent the lids falling off during transport or in stowage. The screw controlling the lid which will be removed when the contents of the case are required must be taken out when the case is stowed in the magazine."

Page 58. *Delete* lines 1-7.

Page 59. After line 25, *add* new paragraph :—

Boxes, Design, C. 171, for Cartridges Q.F. 5.2 in.

"These boxes are used for the stowage in Depot Ships and the transport of Q.F. Cartridges for the 5.2 in. Q.F. gun. When

they contain filled cartridges it is important that special care should be taken in their handling and transport. Boxes are stencilled accordingly."

Page 60. "Sealing of Cordite Cases." *Delete* paragraphs (1) and (2). *Substitute*—

(1) Two station monogram labels are fixed with shellac so as to form a seal. These labels (except for cylindrical cases provided with sealing tapes) are to be placed over the junction of the lid and body, one at each of opposite sides of the lid.

(2) Cylindrical cases which are provided with sealing tapes are to have these labels placed over the ends of the tapes, junction of the lid and locking ring.

Page 78. At the bottom of the table "Markings on Projectiles" *add* new paragraphs :—

"Owing to the poor keeping qualities of the green paint used for painting the bodies of A.P.C. shell and generally to reduce repainting and simplify marking, in future all shell filled H.E. will have the body painted yellow, the red band denoting filled being retained as at present.

"To distinguish the different fillings of H.E., shell filled shellite will be marked as follows :—

12 in. and above ...	12 in. of the cap from the point will be painted green.
Below 12 in. ...	Capped shell will have the cap painted green.
	Uncapped shell will be painted green for a distance of 6 in. from the point.

Shell filled T.N.T. will retain the green band round the body.

Shell filled lyddite, practice, shrapnel, target smoke, star and all powder filled shell will be painted and marked as at present, but the white bands formerly used in A.P.C. and S.A.P. shell will be dispensed with.

One white band above the red filled band will be painted on S.A.P.C. shell to distinguish them from A.P.C.

"Improved quality" 15 in. A.P.C. shell are marked by a blue ring 1 in. wide, painted below the driving band."

Page 90. Fuze Covers. *After paragraph 4 add* :—

"Rubber Covers, No. 3, Mk. I, are supplied to replace Kit Plasters for the temporary protection of Fuzes, T, and T and P. These covers are suitable for Fuzes Nos. 81, 181, 92, 192, 93, 185, also for Fuze No. 80/44 when the soldered on brass cover has been removed.

The following method is to be used when fitting the covers :—

(i) Remove any grease from the nose of the shell where it will come into contact with the cover.

- (ii) Place the cover over the fuze and press it well down into position. The studs on the time ring and body should now be under the thickened band.
- (iii) While holding the point of the cover firmly down on the fuze, turn up the thin edge below the thickened band and paint the under edge of the cover and the shell with Pettman's cement, care being taken that the cement does not come in contact with the fuze itself. It is specially important to ensure a good coating of cement on the portion of the cover in the vicinity of the tab, and on the corresponding surface of the shell.
- (iv) Turn the thin edge down and then run the brush round the joint between the cover and the shell.
- (v) The operation should be carried out under dry conditions.

Covers which have been removed from fuzes are to be preserved and returned to store for reissue after renovation."

Page 130. Paragraph "Night signal box contains :—"

Delete 4 green
4 red
4 white
Very's lights.

Substitute 6 green
6 red
6 white
1" Signal Cartridges.

Paragraph "Sea boats box contains :—"

Delete 10 Very's lights, 5 green, 5 red.

Substitute 12 1" Signal Cartridges, 6 green, 6 red.

Page 131. Paragraph "Steamboats are at all times . . ."

Delete "Very's lights."

Substitute 1" Signal Cartridges.

TECHNICAL LIBRARY
AMMUNITION FACTORY
FOR OFFICIAL USE ONLY.

Attention is called to the penalties attaching to any infraction
of the Official Secrets Act.

This book is the property of H.M. Government.

Its contents are not to be communicated, either directly
or indirectly to the Press, or to any person not holding an
official position in H.M. Service.

O.U. 5267.

AMMUNITION
POCKET BOOK.

1924.

ADMIRALTY, S.W.1
(GUNNERY BRANCH),
G. 837/24.

CONTENTS.

Chapter.	Subject.	Page
	LIST OF TABLES	iii
	LIST OF PLATES	iv
	FOREWORD	v
I.	HIGH EXPLOSIVES Nitroglycerine—Nitrocellulose—Picric Acid, Picric Powder—Trotyl—Amatol—Tetryl.	1
II.	PROPELLANTS Ballistite—Cordite Mark I—Cordite M.D.—Cordite M.C.—Cordite R.D.B.—Nitrocellulose Powder—Gunpowder.	8
III.	MISCELLANEOUS EXPLOSIVES Initiating Explosives—Illuminating and Signal Compositions.	15
IV.	CARTRIDGES FOR B.L. GUNS Manufacture—Marking of Cartridges—Marking of Cases—Labels.	18
V.	CARTRIDGES FOR Q.F. GUNS General Remarks—Q.F. Fixed Ammunition—Q.F. Separate Loading Cartridges—Adapters and Percussion Primers—Keys—Marking.	26
VI.	TUBES Introduction—Detailed Descriptions of Tubes—Marking, Identification and Packing.	43
VII.	BLANK CHARGES Blank Cartridges for B.L. Guns—Blank Cartridges for Q.F. Guns—Marking on Blank Cartridges.	49
VIII.	CASES, BOXES, &c. Weakening of Cases—Rectangular Cases—Cylindrical Cases—Boxes for Q.F. Ammunition—Metal-lined Cases—S.A.A. Boxes.	54
IX.	PROJECTILES Form of Projectiles and Contour of Heads—Effect of Capping—Bursters of Shell—Remarks on Different Fillings—Night Tracers—Driving Bands—Transport of Projectiles—Markings.	63
X.	FUZES AND GAINES General Remarks—Description of Fuzes—Description of Gaines—Description of Detonators.	81
XI.	SMALL ARM AMMUNITION 1-inch A.R. Ammunition—Small Arm Ammunition—303-inch Blank Ammunition—Webley Revolver Ammunition—Aiming Tube Cartridges—Marking and Packing of S.A.A.	111
XII.	STICK BOMBS, STICKS, EXPLODER AND CARTRIDGES FOR ANTI-SUBMARINE USE Introduction—Stick Bombs—Fuzes—Sticks—Exploser and Cartridges.	118

Chapter.	Subject.	Page
XIII.	PYROTECHNICS Rockets—Lights and Flares—Grenades—Signal Cartridges —Firework Boxes—Lifebuoys.	
XIV.	MAGAZINES AND SHELL ROOMS Provision against Flash—Flooding Arrangements—Spraying Arrangements—Ventilation and Cooling—Temperature Tubes.	133
XV.	BOOKS AND FORMS USED IN CONNECTION WITH NAVAL AMMUNITION	145
 Appendix.		
I.	TINFOIL FOR DECOPPERING GUNS	178
II.	SMOKE FLOATS	179

TABLES.

Subject.

Table.	Subject.	Page
1.	A, B, and C. Explosives employed in the Naval Service ..	155
2.	B.L. Charges	157
3.	Q.F. Charges	158
4.	Rectangular Cases	159
5.	Cylindrical Cases	159
6.	Q.F. Cartridge Boxes	160
7.	Metal-lined Cases	161
8.	S.A.A. Boxes	162
9.	Shell for B.L. Guns, 12-inch and above ..	163
10.	Shell for B.L. Guns, 7·5-inch to 5·5-inch ..	163
11.	Shell for Guns 4·7-inch to 12-pdr. ...	164
12.	Shells for Guns, 3-pdr. and below ...	165
13.	Fuses used in Naval Service	166
14.	Ammunition used by Each Nature of Gun ..	167
15.	Stick Bombs and Charges used with them ..	177

LIST OF PLATES.

Description.

CHAPTERS I-III.		Face page
Sheets.		
1 and 2.	Pictorial Representations of Cordite	11
CHAPTERS IV AND V.		
No. of Plate.		
1.	Typical Igniter for B.L. Cartridges	19
2.	Group of B.L. Cartridges (Photo)	20
3.	White Metal Lid, Mark I ...	28
4.	Metal Igniter and Adapter ...	30
5.	Primer Percussion No. 2, Mark VI	32
CHAPTER VI. (TUBES.)		
6.	Tube V.S., Electric S., Large, Mark I ...	44
7.	Tube V.S., Electric, Large, Mark IV ...	45
8.	Tube V.S., Percussion, Large, Mark II ...	46
CHAPTER VII. (BLANK CHARGES.)		
9.	Cartridge Q.F. Blank, 4-inch Mark V and V* Guns	49
10.	Cartridge Q.F. Blank, 12-pdr., 8-cwt., Mark II...	50
11.	Cartridge Q.F. Blank, 3 and 6-pdr. ...	51
12.	Blank Charges (Photo) ...	52
CHAPTER VIII. (CASES, BOXES, &C.)		
13.	Effect of Cordite Explosion in a Bay of Weakened Cases (Photo)	54
14.	Effect of Cordite Explosion in a Bay of Unweakened Cases (Photo) ...	55
15.	Rectangular Case showing Method of Attachment of Top and Bottom ...	56
16.	Typical Rectangular Case (W) ...	56
17.	Group of Cylindrical Cases (Photo) ...	57
18.	Group of Q.F. Ammunition Boxes (Photo) ...	58
CHAPTER IX. (PROJECTILES.)		
19.	4-inch C.P. Shell filled Powder ...	66
20.	15-inch A.P.C. Shell filled Shellite ...	66
21.	4-7-inch S.A.P. filled Lyddite ...	67
22.	6-inch H.E. Shell filled Lyddite (<i>see</i> para.—Remarks on H.E. nose fused, Common Shells and their fuzing and use)	68
23.	12-inch Shrapnel Shell ...	70
24.	12-pdr. Shrapnel Shell ...	70
25.	4-inch Star Shell ...	71
26.	Night Tracer, Internal, Mark III... ..	72
27.	Types of Driving Bands ...	75
28.	Colouring of Projectiles ...	78

CHAPTER X. (FUZES.)

No. of Plate.	Page
29. Fuze, Percussion, Base, Hotchkiss, Mark IV ...	93
30. Fuze, Percussion, Base, Medium, No. 12, Mark XI ...	95
31. Fuze T. and P., No. 92, Mark II... ..	101
32. Fuze Time, No. 185, Mark I	195
33. Fuze Hydrostatic Valve, No. 8, Mark I... ..	106

CHAPTER XI. (S.A. AMMUNITION.)

34. 1-inch Electric A.R. Cartridge—Cordite... ..	111
35. .303-inch Ball Cartridge, Mark VII	112
36. Webley Pistol Cartridge, Mark II	114
37. Distinguishing Marks for S.A. and M.G. Ammunition Boxes ..	116

CHAPTER XII. (BOMBS, &C.)

38. Naval Stick Bomb, 200-lb.	118
39. 4.7 B.L. Cartridge for Stick Bomb	119
40. 12-pdr., 12-cwt. Q.F. Cartridge for Stick Bomb	119

CHAPTER XIII. (PYROTECHNICS.)

41. Rocket, Signal, 1-lb., Service, Mark III... ..	121
42. Rocket, Sound $\frac{1}{2}$ lb., Mark II	122
43. Grenade, .303-inch Rifle No. 32	126

CHAPTER XIV. (MAGAZINE.)

44. Flashlight Scuttle for Turret Handing Rooms (Photo)	134
45. Handing Scuttle (Flap Type)	134
46. "Luck" Scuttle (Photo)	135
47. Flooding Arrangements, Q.E. Class	137
48. Flooding Arrangements for Light Cruisers	137
49. Ventilation and Cooling for Q.E. Class	140
50. Ventilation and Cooling for Light Cruisers	140
51. Locked Temperature Tube, Old Type	144
52. Locked Temperature Tube, New Type	144

CHAPTER XV. (FORMS.)

No Plates	146
-----------	-----

AMMUNITION POCKET BOOK.

FOREWORD.

1. Nothing in this book is to be considered as an authority for disregarding the orders and regulations laid down in the "Naval Magazine and Explosives Regulations" and the "Naval Cordite Regulations."

2. These latter publications are the authority for the necessary care and precautions in the stowage, handling and inspection of Ammunition of all sorts.

3. The regulations for Life Buoys are contained on page 132 of this Handbook (*see also* K.R. and A.I., Art. 641 and 540 (20)).

4. K.R. and A.I. Article 895 is the authority covering the reports of accidents in general with Gunnery Material.

CHAPTER I.

NOTES ON HIGH EXPLOSIVES.

The notes on different explosives are arranged according to the following plan :—

- Introductory remarks.
- Service uses.
- Manufacture.
- Properties.
- Stability and storage.
- Tests.

(1) Nitroglycerine.

Introduction.—Nitroglycerine is obtained by the action of nitric acid on glycerine.

Service uses.—Nitroglycerine is used in the Service almost entirely for the manufacture of propellants of the cordite type. Blasting gelatine is occasionally used in the Service and consists of about 93 per cent. of nitroglycerine, gelatinised with 7 per cent. nitrocellulose, in which way the disadvantage of the liquid condition of the nitroglycerine is overcome. Nitroglycerine may be used also by absorbing 75 per cent. of it in 25 per cent. of an infusorial earth (called Kieselguhr), this forming what is known as dynamite.

Properties.—Nitroglycerine is an oily colourless liquid, which is odourless and only slightly soluble in water, but soluble in organic solvents such as benzine and alcohol. It acts as a poison, and even traces absorbed through the skin produce violent headache. Workers in explosive factories, however, become accustomed to it and experience no ill effect.

When heated, nitroglycerine decomposes actively as the temperature approaches 180° C. (356° F.), and ignites at temperatures in this neighbourhood. Nitroglycerine is liable to freeze when cooled below 13° C. (55° F.).

When nitroglycerine is detonated the products are entirely gaseous.

Nitroglycerine is an extremely powerful explosive, but suffers from several disadvantages. It is very sensitive to impact and friction, its application is difficult on account of its liquid condition, and it is gradually decomposed or hydrolised by moisture, especially if alkali is present.

Stability and storage.—Nitroglycerine is never stored as such for any length of time. Its inherent stability is less than that of guncotton, but its effect in mixtures is largely dependent on the ease with which its products of decomposition, which

accelerate further decomposition, can get away. This removal of gaseous products is easy in the case of dynamite, for example. In a horny explosive like cordite M.D. their escape is more difficult, and unless absorbed by stabilisers they would lead to an unstable condition on warm storage.

Tests.—The principal specification tests applied to nitroglycerine are the Abel Heat Test, and tests for alkalinity and moisture.

(2) Nitrocellulose, guncotton, soluble nitrocellulose.

Nitrocellulose is made from cellulose by the action of nitric and sulphuric acids in a manner analogous to the manufacture of nitroglycerine. Cellulose is the main constituent of the fibres of many plants. Cotton is the purest natural form of cellulose.

Guncotton, the most highly nitrated cellulose used in the Naval service, contains 12·9 to 13·2 per cent. of nitrogen.

By varying the conditions of nitration of cellulose, nitrocellulose containing varying percentages of nitrogen can be obtained, their properties varying with their nitrogen content: thus guncotton is for the most part insoluble, but R.D.B. nitrocellulose of 12 to 12·3 per cent. of nitrogen is soluble in a mixed solvent composed of ether and alcohol. Acetone, however, is a solvent for both this type of nitrocellulose and for guncotton.

Service uses.—Nitrocellulose is used in the Service as guncotton, and as soluble nitrocellulose.

Guncotton is chiefly used for incorporation with nitroglycerine and mineral jelly in the manufacture of cordites, Mark I and M.D. The principal other uses for guncotton in the Service are:—

Wet.—Slabs for torpedoes, mines and demolition work.

Dry.—Primers for detonating slabs, primers as a filling for sound rockets; as an ingredient in the priming composition of electric tubes and detonators; as an ingredient of tonite, which contains 50 per cent. of barium nitrate and is used in sound rockets; and for various other minor purposes.

Soluble nitrocellulose is used in the manufacture of cordite R.D.B. nitrocellulose powder and blasting gelatine.

Properties of the nitrocelluloses. (A) **Guncotton.**—Guncotton when properly made and purified is inodorous and tasteless, and neutral to acid or alkaline test papers. It is met with in the Service in the form of compressed blocks made from pulped guncotton, the fibrous character of the material being visible. It is generally stored in bulk in the wet form as pressed slabs, but small quantities are kept dry for use as primers, wet guncotton not being satisfactorily detonated by a No. 8 detonator without an intermediate primer which is usually made of dry guncotton.

The use of wet guncotton for torpedoes and mines is, however, obsolescent.

In the dry state guncotton is very sensitive to friction or percussion, and should be handled with caution. It is also liable to produce electric sparks in dry weather when subjected to friction. It is readily ignited by a flame and burns into detonation when ignited.

Wet guncotton containing about 17 per cent. of water (20 parts per 100 of guncotton) is only slightly sensitive to mechanical shock, and smoulders slowly, but does not inflame when a light is applied to it.

Care must be taken that wet guncotton is kept wetted with the necessary percentage of water, or it may become dry, and consequently dangerous. For this purpose the tins in which the slabs are packed are fitted with re-wetting plugs, which can be removed so that the necessary weighed amount of water can be added. This quantity can be ascertained by subtracting the weight of the tin at the time of examination, from the weight marked on the tin.

Guncotton is a powerful explosive, but as a high explosive it has been to a large extent superseded by trotyl and amatol. Wet guncotton has neither such a store of energy as trotyl and 40/60 amatol, nor is its rate of detonation as high as that of these explosives, which moreover are more readily filled into torpedoes and mines.

(B) **Soluble nitrocellulose.**—Soluble nitrocellulose, so called because it is soluble in nitroglycerine (in which respect it differs from guncotton) is a material very similar in appearance to guncotton. When dry it is similar to guncotton in sensitiveness and other characteristics.

Stability and storage of the nitrocelluloses.—Guncotton and nitrocellulose prepared for making into propellants are not required to be stored. Guncotton for wet slabs undergoes a slow process of hydrolysis with the formation of salts of calcium and an increase in the solubility in ether-alcohol. This is not dangerous in the wet condition that is maintained.

The calcium carbonate in the dry guncotton of primers acts as a stabiliser. Without it, primers have been found entirely to decompose, while with calcium carbonate only a slow interaction takes place.

Tests.—Guncotton is subjected to the heat test and to a special stability test.

(3) Picric Acid.

Introduction.—Picric acid, or trinitrophenol, is obtained by treating phenol (carbolic acid) with nitric acid.

It is not readily decomposed by the action of moisture and is more stable than such explosives as cordite or nitroglycerine.

Service uses.—Picric acid was first used as a dye, but since 1893 it has been largely used for filling high explosive shell. By neutralising picric acid with ammonia, ammonium picrate is formed and this is an ingredient of picric powder used in exploders for shell. In the cast condition picric acid is known in this country as lyddite, in France as melinite, in Japan as shimose, and in Germany as granatfullung 88.

Properties.—As produced by the manufacturers, picric acid is a fine lemon-coloured crystalline powder with a very bitter taste. When pure it melts at 121.6°C . (250.9°F .) to an amber-coloured liquid.

It is soluble in water to the extent of about one per cent. at 15°C ., and seven per cent. at 100°C . It is not hygroscopic. It does not appear to be poisonous, although it immediately dyes the skin yellow.

Chemically, it is a fairly strong acid and reacts with metals and some of their compounds to form salts, the picrates. Some of these are sensitive to shock, the most sensitive being lead picrate, which is readily detonated by a light blow, or still more readily by friction or by contact with a flame. The detonation of certain of these picrates in sufficient quantity would reproduce the effects of a fulminate detonator and cause the detonation of any picric acid in contact with them.

For this reason great precautions need to be taken to prevent picric acid from coming into contact with these metals and their compounds, especially when it is in a molten or moist condition. Lead picrate is the most dangerous, and paints containing lead compounds are forbidden to be used on any articles which may come in contact with picric acid; a limit for lead content is also put on all articles such as brass for fuzes, plugs, tools, &c., liable to come into contact with the acid. Oil used for cleaning the shell should be lead-free.

Stability and storage.—Picric acid is chemically a stable substance, and is capable of withstanding warm storage in the hottest climates without being affected.

Ammonium picrate and picric powder.

Ammonium picrate is formed by neutralising the picric acid with ammonia. It is an orange-yellow crystalline body, and is itself an explosive of considerable power, although an insensitive one. A finely ground mixture of this with potassium nitrate in the proportion of 43 to 57 is known as picric powder. Picric powder ignites readily and burns with violence. It is used as an exploder for certain shell filled with lyddite or shellite when the explosion is brought about by means of a flash from gunpowder, and not by a detonating system involving the use of fulminate. The sensitiveness of the mixture is greater than that of picric acid, and it is necessary to keep it dry.

(4) Trinitrotoluene.

Introduction.—Trinitrotoluene, commonly known as T.N.T., is also sometimes called by its commercial name "Trotyl."

Service uses.—Before the war, trotyl was used as a Service explosive to a limited extent as a filling for exploder bags, but experimental methods of filling shell of the larger sizes with T.N.T. had already been investigated.

Shortly after the war began it was adopted as a filling for certain high explosive shell and torpedoes, and early in 1915 mixtures of ammonium nitrate with trotyl, known as amatols, came into use.

Properties.—Trotyl varies in colour from nearly white to a reddish brown. It melts to a brown liquid which solidifies to a crystalline mass at a temperature of 180° F. In the pure state it has no smell. Crude trotyl sometimes has an irritating smell, due to the presence of chemical impurities.

T.N.T. does not dissolve appreciably in water, and it is not hygroscopic.

Trotyl is slightly poisonous, and precautions are taken in manufacture and filling to protect the operators by preventing contact with the skin and breathing in of dust as much as possible, and by arranging for cleansing of the skin and the use of clean clothing.

Trotyl is a violent and powerful high explosive, being in these respects only slightly inferior to picric acid. It has a high rate of detonation, 6,950 metres per second at a density of 1.57. Being deficient in oxygen for complete combustion, it gives a black smoke of carbon particles on detonation, and carbon monoxide gas, which is poisonous. It is less easily inflamed than picric acid, although that does not inflame readily, and is considerably less sensitive to shock than that explosive.

Stability and Storage—The chemical stability of unmixed trotyl is such as to present no danger of spontaneous ignition in any warm climate or condition that may be met with in the Service.

(5) Amatol.

Introduction.—Amatol is an intimate mixture of ammonium nitrate and trotyl. Its use was proposed in 1915, with the object of economising trotyl, at the same time taking advantage of the excess of oxygen possessed by ammonium nitrate to compensate partially or completely for the deficit of oxygen in trotyl.

The amatols in use are 40/60, 50/50 and 80/20, the first-named figure or numerator always referring to the percentage of ammonium nitrate.

Service uses of amatol.—During the war amatol ultimately became the principal high explosive used in the land service. In the naval service it was used to a smaller extent, as, for

example, for filling mines, howitzer shell, depth charges, &c.; it is also largely used in the air service for filling bombs.

Properties.—Amatol 40/60 when cast has the grains of ammonium nitrate coated with trotyl and they are thereby somewhat protected against moisture. Amatol 80/20 for shell filling easily takes up moisture from the air. If the constituents are pure no physical or chemical change goes on in amatol, but in supply various grades of both constituents have had to be accepted containing small quantities of impurities.

The principal objection to the impurities liable to occur in amatol is that they may cause "exudation." Although the amatol is solid at ordinary temperatures some of these impurities have a far lower melting point and may be liquid at ordinary storage temperatures. Such liquid impurities may be more sensitive to blows than amatol, and are also liable to soak into exploder bags and deaden the exploders, thus causing "blinds."

The design of projectiles, bombs or other weapons which are to be filled with amatol are complicated by the necessity of providing precautions against such exudation.

The most common and most troublesome exudation from amatol is the oily impurities which T.N.T. is liable to carry. If oily T.N.T. gets into a fuze hole thread, for instance, it might be a source of danger, and it is particularly liable to soak into and deaden an exploder.

The use of any but the highest grades of amatol for naval purposes is not favourably regarded therefore, and this explosive is not likely to have an extended use in future for naval weapons, except under the pressure of necessity and shortage of other materials such as occurred in the recent war.

Explosive properties of amatol.—Amatol 40/60 gives less smoke than trotyl when it is detonated, and since in 80/20 amatol the combustion is complete, very little smoke is produced. In consequence, mixtures for producing smoke to indicate the point of burst are introduced into large shell filled with 80/20 amatol. In rate of detonation and violence, 40/60 is little inferior to trotyl, but 80/20 is distinctly lower, although the values are still considerable. The total energy of 80/20 is higher than that of either, and this, together with its lower rate of detonation, makes it peculiarly suitable for land service shell, since it fragments the shell sufficiently, and, by reason of a more prolonged blow, projects them further; these properties, in addition, make it useful for lifting earth.

Amatol 40/60 is of about the same sensitiveness to impact as trotyl, amatol 80/20 slightly less sensitive and considerably more difficult to bring to complete detonation, requiring special initiating systems of violent intermediate explosives.

Stability and storage.—The amatols are stable explosives that they are not liable to undergo spontaneous ignition. It must not be exposed to damp, on account of the hygroscopic nature of the ammonium nitrate.

(6) Composition exploding.

Introduction.—Composition exploding is briefly known in the Service as "C.E." Its principal use is as an intermediary between the initiating fulminate detonator and the main charge of explosive. Owing to its having a higher degree of sensitiveness than the explosive constituting the main charge, it responds readily to the impulse of the detonator, while its great power and violence ensure effective detonation of the charge.

C.E. is used as a filling for the magazines of detonating fuzes and gaines, and in primers for torpedoes, naval mines, depth charges, bombs, &c. It is used for the exploders of shells when these are liable to be contaminated by infiltration of trotyl exudation from the filling, since it possesses the advantage over trotyl for this purpose that its detonating properties are not affected by the presence of this exudation.

Properties.—C.E. is a crystalline substance of a pale yellow colour, and for Service purposes is in the form of fine crystals or powder. It is not used in the cast condition on account of its high melting point. It is practically insoluble in water and is not hygroscopic. It is liable to produce skin inflammation in some people, but is not poisonous.

C.E. is more readily ignited than picric acid or trotyl, and more sensitive to shock and responsive to initiation by fulminate. It is, however, still insensitive enough to permit of its being used in columns of short length in shells where it is subjected to severe shock on set back. Owing to its high rate of detonation, high energy content and capability of producing very rapidly an intense pressure, as well as to its readiness of response to detonation, C.E. is very suitable for the purpose for which it is used, *i.e.*, to reinforce the effect of fulminate, which can be permitted in small quantities only on account of its extreme sensitiveness.

Stability and storage.—Purified C.E., while less stable than trotyl or picric acid, has a sufficiently high degree of stability to free it from any suspicion of liability to undergo deterioration or spontaneous decomposition under conditions of Service use. This has been established by warm climatic trials, and is confirmed by experience abroad.

CHAPTER II.

PROPELLANTS.

When Schönbein discovered guncotton it was hoped that the question of a suitable smokeless powder for guns had been solved, but attempts to use fibrous guncotton as a propellant were attended by failure. No method of winding or compression was found capable of regulating the rate of burning.

It was only when the control of the rate of combustion of the explosive was made possible by gelatinisation that there was progress. By gelatinisation the fibrous nature of the nitrocellulose is destroyed and converted into a jelly or dough, which is capable of being worked into any convenient form. These dense masses will burn comparatively slowly and regularly from layer to layer even under the pressures set up during their combustion in the gun.

Pressure increases the rate of burning, and high initial pressures such as would strain or burst the gun are avoided by the use of a suitable size of cord.

The usual method of gelatinising nitrocellulose is by means of a volatile solvent, acetone being used for guncotton, and ether-alcohol for the soluble nitrocelluloses. The gelatinisation is performed in an incorporator, the dough is pressed into the desired form, and the solvent is then dried off and a large proportion of it recovered. In nitrocellulose powders soluble nitrocellulose is generally used and ether-alcohol is the solvent.

Cordite Mark I.

Sir Frederick Abel and Professor Dewar found that, if guncotton and nitroglycerine were mutually taken up by a liquid capable of dissolving them both, on evaporating off the solvent (acetone), the guncotton and the nitroglycerine remained behind in a completely incorporated condition as a gelatinous mass.

The composition of the first British smokeless powder made on this principle was:—

Nitroglycerine	58	per cent.
Guncotton	37	"
Mineral jelly	5	"

This was originally called cordite on account of the cord-like form into which it was pressed. Since the introduction of cordite M.D. the original cordite has been generally called cordite Mark I for the purpose of distinction.

The mineral jelly (a product of petroleum distillation) was originally introduced for the purpose of reducing the wear on

the bore of the gun, but it was found subsequently by investigations on the keeping properties of cordite, that mineral jelly had the important function of acting as a stabiliser, and prolonging the life of cordite by reacting with the acids produced by the decomposition products of the cordite, thus preventing them from accelerating decomposition.

Manufacture.—The manufacture of cordite Mark I is similar to that of cordite M.D. (see below), except that the proportions of the ingredients are different, and that Mark I cordite employs only half as much solvent.

Properties.—Cordite Mark I is soft and pliable, owing to its high content of nitroglycerine. For the same reason it produces a very high temperature on explosion, and causes severe erosion of the bore of the gun.

Cordite M.D.

Experience with cordite Mark I showed that, owing to the excessive erosion of the bore which it produced, shooting was rendered inaccurate after a comparatively small number of rounds had been fired. This was clearly demonstrated during the South African campaign.

Experiment led to the adoption of a modified cordite known as cordite M.D. of the following composition:—

Guncotton	65 per cent.
Nitroglycerine	30 "
Mineral jelly	5 "

Owing to the smaller amount of heat developed on explosion the life of a gun using M.D. cordite is much longer than with cordite Mark I.

Cordite M.C.

Cordite M.C. is similar to cordite M.D. except that the mineral jelly has been specially treated with a view to increasing its stabilising value as described above, and so prolonging the life of the cordite.

Cordite M.D.T.

This is pressed in a tubular form. M.D.T. is not used for Naval Service cartridges, but it may be found in some small arm ammunition.

Blending of cordite lots.

The amount contained in a lot of cordite varies according to the size, e.g., size 45 contains approximately 40,000 lbs., whilst size 44 contains only about 5,000 lbs. In the case of larger sizes the blending of different batches is effected by placing one box of each batch on a table and taking equal quantities from each box to mix in a box on a second table. The operation is

CORDITE S.C. (Solventless Centralite Cordite.)

The advantage of these Solventless Propellents is mainly that they do not have to be dried.

Cordite S.C. can be made and Fired the same Day.

No details are available as to composition.

It has been adapted for use in the Naval Service and will replace MD. and MC. It will be known by the decimal of an Inch which represents the mean actual diameter of the cords: e.g. 280=B.L. 15". 205=B.L. 8".

100=4.7". S.C. Cordite will bear the initials R.N.C. in front of Lot Number.

All S.C. Cordite will be sufficiently identified by for most purposes by quoting the initials and the lot Number. The "Size" should be furnished also where called for in returns.

A.F.O. 1826/1928.

performed by a queue of men each taking a handful from each box.

Blending is very necessary to compensate for the variations in the diameter of the cords and thus to give uniform ballistics.

Delivery and selection for proof, examination and test.

The lots are numbered consecutively in order of manufacture. Each lot is given a number which, prefixed by the distinguishing letters of the firm, is used to designate the lot.

Each lot is subjected to the following inspection:—

- (1) Firing proof To check correctness of the ballistics given by the lot against the "standard" for that size of cordite and to enable the charges to be "adjusted."
- (2) Chemical examination. Analysis and heat tests.
- (3) Visual inspection ... To see that the cordite is dry, homogeneous, and free from visible defects and impurities.

Immediately on receipt of a lot a small sample is sent to the chemist for heat test and chemical analysis, and a number of boxes, sufficient to provide for firing proof, is selected and despatched unopened to the proof butts at Woolwich.

At the proof butts the contents are made up into cartridges of the specified weight for firing proof.

(1) **Firing Proof.**—This consists in firing five rounds of the lot against two or more rounds of a standard lot in the nature of gun laid down in the specification for the size of cordite.

Proof shot of the correct weight and banded with the Service driving band, are used at the proof butts. Service shell could be used, if the range were suitable, provided that the same nature of projectile was used throughout the shoot.

Velocities are measured by chronograph.

Pressures are measured by copper cylinders contained in crusher gauges. They are placed in the chamber in rear of the charge in B.L. guns and inside the case for Q.F. guns.

The Proof and Experimental Officer calculates the muzzle velocities of all rounds from these observed velocities.

System of proof.—The ballistics found by firing are corrected to the ballistics that would be given in an average new gun at 80° F. at its ninth round.

Having obtained the corrected ballistics of a lot, the Proof and Experimental Officer calculates the charge which should give a specified velocity, usually the mean of the specification, which is called the velocity of adjustment. This charge is called the adjusted charge of that lot and is the weight to which the charges of the lot are made up.

PICTORIAL REPRESENTATIONS OF CORDITE

SHEET 1.



1



2



3



4



5

1. }
2. } NEWLY MADE CORDITE.
3. } SHOWING RANGE IN COLOUR.
4. }

5. EARLY STAGE OF CORROSION OF
CORDITE MD. SIZE 16.

PICTORIAL REPRESENTATIONS OF CORDITE.

SHEET 2.



6



7



8



9

6. INTERMEDIATE STAGE OF CORROSION OF CORDITE MD. SIZE 19.
7. ADVANCED STAGE OF CORROSION OF CORDITE MD. SIZE 16.
8. ADVANCED STAGE OF CORROSION OF CORDITE MD. SIZE 8.
9. CORDITE CONTAINING AIR BUBBLES.

Guns for cordite proof are not as a rule used for other purposes, as it is most desirable that the behaviour of the gun should be watched throughout its proof life. If the gun becomes irregular or worn, or if the correction for ballistics becomes too big, the gun is discarded and replaced by a fresh one.

(2) **Visual examination.**—This is carried out by the Inspection Department.

In order to comply with the specification, the cordite must be externally dry, homogeneous, and free from foreign matter; the sticks must be straight, be within the limits of length laid down, and must not show any splits, and the ends must be evenly cut.

There should not be an excessive number of sticks containing air bubbles. Further, the maximum difference in weight between individual sticks, cut to a length of 10 inches, must not exceed a certain amount. To ensure that the cordite complies with the above conditions, it is subjected to a visual examination.

Finally.

The lot, having passed the firing proof, chemical examination, including a second heat test and visual inspection, is then accepted into the Service and delivered to the Filling Stations for making up into cartridges.

Appearance of corroded cordite.

(Sheet 1 and Sheet 2.)

In newly made cordite of different manufacture the colour varies from lemon yellow to a deep brown; the range in colour is shown in Figs. 1 to 4. On account of the wide variations, the colour cannot be taken as any indication of age, although during the storage of cordite a slight darkening sometimes occurs. This is, however, no indication of deterioration.

An early stage of corrosion is shown in Fig. 5. It is indicated by a portion of the stick, when viewed by transmitted light, being more translucent than the unaffected cordite. A nucleus of foreign matter is generally present.

As the condition of corrosion progresses, the nucleus of foreign matter becomes surrounded by an opaque region. An outer region of greater translucency is still visible. This is shown in Fig. 6.

Examples of corrosion in a more advanced stage are shown in Figs. 7 and 8. In these, the opaque region surrounding the nucleus of foreign matter increases in size and depth of opacity, the nucleus of foreign matter becoming hidden. The corrosion gradually progresses from this stage along the length of the stick.

Occlusions of air in cordite have to some extent the appearance of the condition of advanced corrosion. A stick of cordite containing air bubbles is shown in Fig. 9. The dark portions

show the appearance when viewed by transmitted light, and the light portions when viewed by reflected light. The chief difference in appearance between air bubbles and an advanced corrosion is that the air bubble is not surrounded by a region of greater translucency than the unaffected cordite.

An air bubble can be definitely distinguished from a corrosion spot by cutting down into the cordite at an angle with a sharp clean knife, and applying to the region moistened blue Service litmus paper under the usual precautions as regards handling. In the case of a corrosion, the nuclear region reacts strongly acid, turning the litmus paper locally bright red.

N.B.—The coloured representations of cordite are twice natural size.

Properties of Cordite M.D.—Cordite M.D. is harder than cordite Mark I, and more brittle, so that it breaks when bent to an excessive extent. The proportions of the ingredients are arranged to give a lower temperature of explosion, and consequently less erosion of the gun, than Mark I. It burns somewhat more slowly than cordite Mark I in the gun, and its total energy content (as measured by its heat of explosion) is lower, so that larger charges of cordite M.D. are required than of cordite Mark I.

Ignition and rate of burning.—In its usual form of sticks made up into a cartridge, cordite is more difficult to ignite than grain gunpowder, which is used as an intermediary between the flash of the primer and the cordite charge. The smaller the diameter of the sticks the easier it is to ignite, and the quicker it will burn.

Cordite ignited in small quantities in the open burns fiercely. When burning larger quantities there is danger of explosion if it is packed close together.

Cordite of small diameter can be brought to explosion when ignited in a close space or subjected to the action of a fulminate detonator.

Gases from ignition of Cordite.—When cordite is fired under high pressure, as in a gun, it is resolved into the gases carbon dioxide, carbon monoxide, water vapour, nitrogen and hydrogen. Of these, carbon monoxide is poisonous.

When it is burned in the open, but without free access to air, nitrous gases may also be formed, which are poisonous and also irritating.

Sweating of Cordite.—Sweating of cordite due to exudation of nitroglycerine may occur on subsequent warming, after storage at temperatures below 45° F.

Cordite should not be handled when in a sweated condition but should be kept at a moderate storage temperature (say 60° F.), when the nitroglycerine will be re-absorbed.

Felt wads or other absorbent material should not be left in actual contact with the cordite, as after a prolonged period nitroglycerine from the cordite may be absorbed by the wads, rendering them highly explosive. It is for this reason that wads

in Q.F. ammunition have glazed board discs on the side next the cordite.

Smoke developed by Cordite.—Although guncotton and nitro-glycerine are perfectly smokeless, the rapid firing of cordite gives rise to a fog or haze which, when large charges are used, is rather troublesome. This haze, which in some cases becomes a thick yellow smoke, consists of condensed water vapour, smoke from the powder primer and cartridge bag, together with oxide of copper from the driving bands.

Backflash.—Of the gaseous products yielded by cordite M.D. on firing, 70 per cent. are inflammable gases, and these mixed with air in the gun after firing give an explosive mixture, which sometimes ignites when the breach-block is opened and causes the flame known as backflash. To prevent backflash a blast of air is injected into the bore of large guns.

Stability and storage of Cordite M.D.—During the storage of cordite M.D. and, in general, of nitro-compound explosives a slow but continuous decomposition is going on. This decomposition results in the formation of free nitric and nitrous acids among other products, and these acids, if not neutralised, greatly accelerate the rate of decomposition of the explosive. It is for the purpose of combining with the acids produced in decomposition, and preventing them from exerting this deleterious effect, that stabilisers, such as mineral jelly and diphenylamine, are added to propellants.

If the decomposition proceeds far enough sufficient heat may be generated by the process to ignite the cordite. To guard against this, periodical tests are carried out, from the results of which the probable safe life of the cordite can be predicted. Although such tests may show that the cordite is unserviceable or has but a short safe life, yet the amount of decomposition is small, and is not usually sufficient to affect ballistics.

At the temperature laid down for ships' magazines decomposition is exceedingly slow. It is of the greatest importance to keep these magazines below the prescribed limit of temperature.

Gunpowder.

Introduction.—Gunpowder, or black powder, is one of the oldest of explosives. Service gunpowder is a mixture of 75 parts by weight of potassium nitrate (saltpetre), 15 of charcoal and 10 of sulphur.

Service uses.—As a propellant, gunpowder has been almost entirely superseded by smokeless powders, but it is still used as priming, and in the magazines and time rings for some fuzes and for igniters of propellant charges. It is also used for bursting charges of certain types of projectiles. Varieties of gunpowder in which the proportions of the ingredients are somewhat different from the standard, are used as the propelling charge in rockets.

Properties.—Gunpowder is a mixture whose efficiency depends on the perfection with which its incorporation has been carried out.

The hardness of the grains, their size and shape and the condition of the glaze on their surfaces also affect the rate of explosion of powder.

The explosive properties of gunpowder depend on its being a mixture of bodies none of which are themselves explosive, all interaction having to take place between particle and particle. Thus it is slow in its action, its effects not being violent when compared with high explosives. The porous nature of gunpowder facilitates its easy ignition by a flash, and this is made use of in many components of ammunition. It is somewhat sensitive, being more sensitive to impact and friction than picric acid. Tools for working with gunpowder are made of copper or bronze.

Stability and storage.—Gunpowder when kept dry can be stored indefinitely in any dry climate. If allowed to get damp the potassium nitrate reacts readily with copper or metals containing it, and may be absorbed from the gunpowder by paper, unless this is varnished.

Tests.—Gunpowder is examined by analysis to ensure that the ingredients are present in correct proportions.

The density of gunpowder and its content of moisture are important as affecting its rate of burning. Its tendency to take up excess of moisture is made the subject of a special test (hygroscopic test).

In grained gunpowder such as R.F.G.² the uniformity of size of grain is tested by sieving.

By flashing it on glass completeness of incorporation is determined by the amount of residue left behind.

Forms of powder and other Service explosives.

A list of the principal powders, and other explosives, employed in the Naval Service, and their uses, is given in Table I at the end of this Book. It is under consideration, however, to do away with all the different specifications for gunpowder and to use one composition for all purposes, merely varying the dimensions.

CHAPTER III.

MISCELLANEOUS EXPLOSIVES.

Initiating explosives.

Introduction.—The class of initiating explosives or detonants consists of explosives of a sensitive character, which are readily brought to detonation by a flash or by friction or percussion. Although there are numerous explosives of this type known, most of them suffer from serious drawbacks, such as instability or unreliability. In the Service at present, mercury fulminate or mixtures containing it are the only explosives of this class in use.

In ammunition the initiating explosive is always contained in a metal sheath, forming a detonator, it being necessary to prevent leakage of the explosive on account of its sensitiveness.

Mercury fulminate.

Service uses.—Mercury fulminate is used in the Service in fillings for detonators and ignitory caps. In ignitory caps, fulminate is used in various mixtures, of which examples are given under the heading of "Cap Compositions." It is sometimes compressed into the detonator and sometimes filled without compression.

Manufacture.—Mercury fulminate is made by dissolving mercury in nitric acid. It is stored in bulk in the wet condition, and small quantities are dried under precautions at a low temperature when required for use.

Properties.—Mercury fulminate consists of small crystals, having in bulk the appearance of fine sand. Its colour is usually grey or brown unless it has been bleached in the manufacture by the addition of copper salts, when it is white.

The solubility of fulminate in water is very small, and it is not hygroscopic. In common with other mercury salts, it is very poisonous. It is dissolved and decomposed by a solution of sodium thiosulphate ("hypo"), which is the best reagent for destroying it when necessary.

Mercury fulminate is characterised by having a considerably greater sensitiveness to impact and friction than other Service explosives. It is at the same time very violent, and though its rate of detonation (about 3,000 metres per second) is not high compared with other explosives, a small initial impulse brings it to its full rate of detonation in an extremely small period of time. This instantaneous explosive decomposition in a substance of such high density is favourable for giving the intense and localised blow necessary for bringing to detonation an explosive

in contact with it. To obtain the full effect of fulminate it is necessary to have it well confined; a few grains in the loose condition when ignited may burn without violence.

Stability and storage.—Warm damp storage has a deleterious effect on fulminate, decomposing it and causing interaction with its metallic envelope. Precautions such as varnishing are therefore adopted to prevent moist air entering. But dry warm storage also renders fulminate incapable of initiating detonation. Detonators should be stored either housed in their appropriate fuzes or specially packed in boxes. Great care should be exercised in handling them, and no attempt should be made to dissect them.

Cap compositions.

These mixtures are the primary means for starting off an explosive reaction which proceeds from a process of burning as distinct from the dynamic effects of a purely detonative impulse.

These mixtures are used in various forms of percussion caps which are either pierced by a needle or struck on an anvil, and in friction tubes where they are actuated by a notched bar working over a roughened surface. Nearly all these compositions consist of potassium chlorate and antimony sulphide; and most of them contain fulminate of mercury; others contain in addition gunpowder, sulphur and ground glass.

Characteristic compositions are :—

Composition.	Modes of ignition.		
	Percussion (S.A. cap).	Pricking by needle (1·7 grain detonator).	Friction bar (friction tubes).
Mercury fulminate	8	6	
Potassium chlorate	14	6	12
Antimony sulphide	18	4	12
Gunpowder -		—	1
Sulphur -			1
Ground glass -			1

Illuminating and signal compositions.

The majority of the compositions designed for illuminating purposes, such as those used in star shell, night tracers, &c., consist essentially of a mixture of magnesium or aluminium powder with oxidising agents such as barium nitrate. This type of mixture gives a very intense illumination. Other

ingredients are sometimes added for the purpose of modifying the colour of the light, or for reducing the sensitiveness of the mixture.

Compositions of similar type, intended for signalling purposes and not required to give an intense illumination, are made without magnesium or aluminium, sufficient light for the purpose being produced by the combustion of charcoal or organic material such as shellac. Various colours are produced by the use of suitable components in the mixture. These compositions are used for "Very" signals.

Properties.—Illuminating compositions differ from explosives in that they are intended to burn regularly at the surface in a slow and controlled manner.

In general, illuminating compositions are more sensitive than ordinary high explosives, the sensitiveness, especially to friction, of mixtures containing chlorates being undesirably high. They are also readily ignited by a spark or flame, especially when in the loose condition.

Stability and storage.—Service compositions when perfectly dry are extremely stable and suffer practically no deterioration during storage under ordinary conditions. If, however, a small quantity of moisture gains access to the composition, through ineffective sealing for instance, deterioration may set in, especially in those compositions containing magnesium or aluminium.

CHAPTER IV.

CARTRIDGES FOR B.L. GUNS.

General Remarks.

For safety, convenience and rapidity in loading, the cordite charge for B.L. guns is placed in a bag and is then called a "cartridge." The empty bag is known as the "empty cartridge."

The material of which the cartridge bag is made should possess the following qualifications:—

(1) It must be strong enough to bear reasonable knocking about when filled, and to stand the wear and tear of travelling.

(2) It should be so close in texture that the explosive, or dust from it, will not readily work its way through.

(3) It should have good keeping qualities, and not be affected by chemical action of the explosive.

(4) Lastly, and this is of great importance, the material should be entirely consumed in the gun when fired, or at least should not leave any smouldering fragments or sparks in the chamber or bore.

Silk cloth fulfils the above conditions more perfectly than any other material, and is therefore used for nearly all B.L. cartridges.

Cream serge is also used for certain cartridges up to 10 lbs. in weight.

All silk sewing used in making up B.L. cordite cartridges is first greased with mineral jelly to prevent rotting. Silk braid and webbing are also used for securing charges. Silk webbing is stronger than silk braid.

Igniters.—As cordite is somewhat difficult to ignite, every B.L. cartridge is fitted with one or more igniters, consisting of a bag containing R.F.G.² powder.

The igniter is made of two discs of shalloon dyed red, sewn together at the edges and divided into parallel compartments by rows of stitching. This secures an even distribution of the powder. Igniters used with cartridges 5·5-inch and above have a silk cloth or cream serge disc sewn to the underside to prevent the cordite from penetrating the shalloon.

Some old pattern igniters with radial stitching may still be met with, but none of these have been made for some years, nor will be in future.

A millboard disc, covered with silk cloth and marked with a red cross, is placed over the igniters fitted to cartridges for 7·5-inch guns and above. It is secured to the cartridge bag by silk sewing in 2 places (4 places for 15-inch) and is to be torn off before firing.

CARTRIDGES. FAILURE TO IGNITE. B.L. CHARGES. A.F.O. 3260.

On several occasions recently tubes in B.L. Guns have fired but failed to ignite the charges. A careful review of all the available evidence leads to the conclusion that the most probable cause is the presence of water in the vent which is known to result in such occurrences.

Trials have shown that vents have fully dried by use of the air Blast vent clearer where fitted, provided that the air is drawn from properly drained air bottles.

Where air blast vent clearers are not fitted, trials have shown that the implement vent clearer is a satisfactory substitute. It is therefore most important where air blast vent clearers are fitted that the air bottles should be carefully drained before firing commences.

With heavy guns of 13.5 calibre and above, the air blast vent clearer should be kept on the whole time the wash out squirts are in use. When an Air blast vent clearers are not fitted the vent clearing implement should be inserted as soon as the breech is open and not withdrawn till the washout squirts have finally shut off.

With lighter guns it will not usually be possible to use a vent clearer every round without seriously reducing the rate of fire. The risk of a missfire due to water in the vent must therefore be accepted. Every opportunity of a delay or lull must however be to use the vent clearer supplied.

Nothing in this order is to be taken as affecting the full use of water for washing out the chamber or sponging over the mushroom Head as laid down in the drill books,

The "tear-off" disc is removed from the cartridge at the last stage of handling.

In later pattern "tear-off" discs, the silk cloth is sufficiently large to overlap the edge of the charge, as in Pl. 1, and then drawn in with a drawstring of white tape.

The igniters of some cartridges are protected from flash by covering the igniter with a double silk cloth cover, which can be removed before entering the charge in the gun, and the number of igniters in B.L. charges above 6-inch is also being reduced. These silk cloth covers will replace the "tear-off" covers.

Lifting bands and Handling beackets.—All B.L. cartridges above 6-inch have fairleads of silk or shalloon braid, secured to opposite sides, and another on the base. Through these a length of 1-inch linen tape, bleached cotton webbing or silk braid is passed and tied on the top, thus forming the lifting band or becket for handling the cartridge. It is to be removed under the same conditions as the "tear-off" cover. For B.L. 6-inch cartridges the tape band is passed through the loops on the cartridge bag.

X AFO
S 2/30

All cartridges B.L. 7.5 inch and above are fitted with braid beackets sewn to the bag at the opposite end of the cartridge or the igniter.

Full and Fractional Charges.—All charges for 4-inch and 4.7-inch B.L. guns, and star shell charges for B.L. 6-inch and 5.5-inch guns, are made up in one cartridge with an igniter at each end.

Charges for the heavier guns are made up in fractions for convenience in handling and transportation. Each fractional charge is at present fitted with one igniter. The fractions used are $\frac{1}{2}$, $\frac{1}{4}$, $\frac{1}{8}$, and $\frac{3}{8}$ charges. All charges for B.L. 15-inch and 12-inch guns are supplied in $\frac{1}{4}$ charges. Charges for B.L. 9.2-inch and 7.5-inch guns are supplied in $\frac{1}{4}$ and $\frac{1}{2}$ charges.

Charges for B.L. 6-inch Marks VII, XI, XII and XIV, and 5.5-inch guns are supplied in $\frac{2}{8}$ and $\frac{1}{8}$ charges laced together. The $\frac{2}{8}$ charges form practice charges (see below) and two $\frac{1}{8}$ charges can be laced together to form a $\frac{3}{8}$ charge.

Reduced charges for practice, and star shell.—For certain practice firings reduced charges are used to save the wear of the gun. To differentiate from these, the Service charge is known as the full charge. Special reduced charges are also used for firing star shell.

All the guns, 7.5-inch to 15-inch, use charges equivalent to three-quarters of the full charge as the practice charge. For 6-inch and 5.5-inch B.L. guns $\frac{3}{8}$ charges are used, except in earlier ships carrying 6-inch charges made up in halves.

B.L. 4.7-inch and 4-inch guns are supplied with special reduced charges for practice or for use with star shell.

Special reduced charges are also provided for use in 6-inch B.L. guns.

CHARGES FOR HAND-WORKED B. L. GUNS.

Designs of Charge with an Igniter at one end only have recently been introduced for certain handworked B.L. Guns, for which the charge is a single cartridge. The number of such designs may be increased.

These Charges can readily be loaded with the Igniter to the rear, even in the Dark because they are bottle shaped, the diameter of the Igniter end being approximately double that of of the front end.

The Guns already affected are:-

B. L. 6.in. Mark XX11. Service Charge.

B. L. 6.in. all Marks. Star Shell Charge. (Newest Designs)

B. L. 4.7. Mark. 1. Practice Charge.

B. L. 4.7. Mark. 1. Star Shell Charge. (newest designs)

B. L. 4.in Mark 1X. Star Shell Charge (newest designs).

When Charges of this type are placed in Clarksons Cases they are to be entered with the Igniter down and the Stalk up.

A. V. O. 1426/1928.

B.L. CHARGES:-

All B.L. Charges of current Manufacture are fitted with overall lifting bands to assist in the removal of of the charges from the cordite cases.

The overall lifting bands are made of linen tape, webbing or braid and the ends are secured by a bow hitch. They should not be confused with either the lifting buckets sewn on to the certain charges or the igniter covers.

They are to be removed when charges are withdrawn from the magazines for passing to the guns i.s. in the magazines except for charges in the cases at ready use positions.

If removed, the overall lifting bands should be replaced on charges prior to replacing them in their cases when this is permitted under Articles, 28, 31, 32, and 42, of the Naval Magazine and Explosive Regulations, 1928.

A. F. O. 890/1929.

TYPICAL IGNITER FOR B. L. CARTRIDGES.

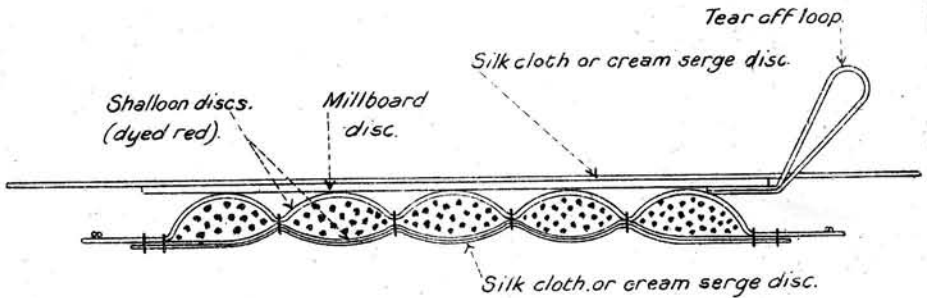

SECTION WITH COVER.

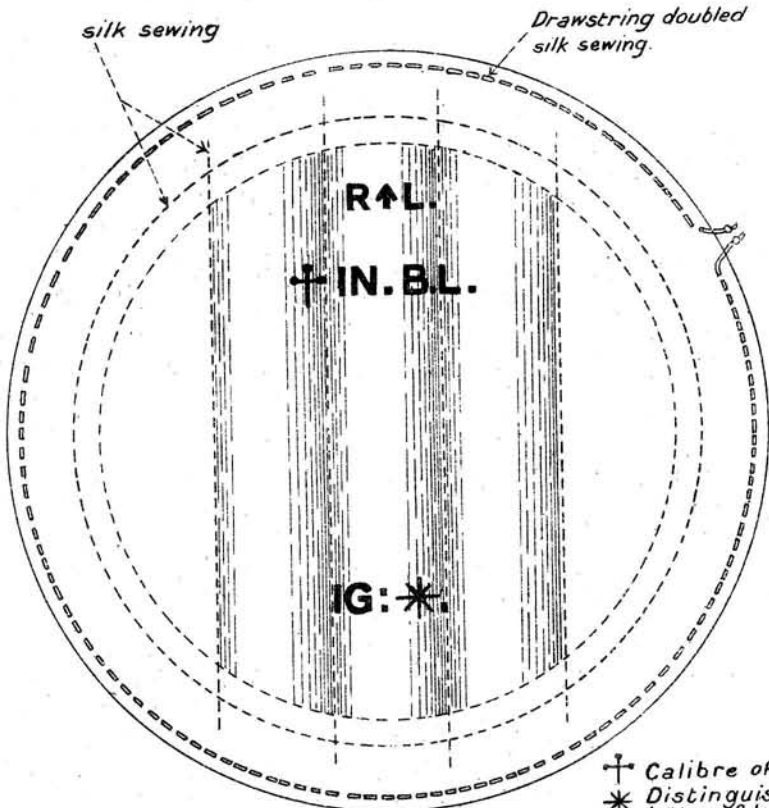

PLAN OF IGNITER WITH COVER REMOVED SHOWING MARKING.

Marking and packing of B.L. cartridges. (Plate 2.)

B.L. cartridge bags are marked as follows:—

- Numeral of the cartridge.
- Initials or trade mark of maker of empty bag.
- Nature of gun.
- Weight of charge.
- Nature of the cordite used.
- Size of the cordite used.
- Fraction denoting size of charge, *e.g.*, $\frac{1}{4}$, $\frac{1}{2}$, &c.
- REPd denotes that the cartridge has been repaired, probably by retying charge, restitching or replacing bag, or igniter.

Future supplies of B.L. cartridges will be marked as shown below:—

B.L. Cartridges.

(1) Printed on both sides of bag:—

- Mark of cartridge.
- Monogram of maker of bag.
- Calibre ("Howitzer" or "Bomb Thrower" where applicable).
- Letter "N."
- Weight of charge.
- Lot number of cordite.
- Nature and size of cordite.
- Fraction denoting fraction of full charge.
- Monogram of filling station.
- Date of filling (month and year).

(2) Cartridges fitted with new bags are to have the original markings stencilled on them in addition to the date and place of remarking.

Marking for B.L. Gun Cartridges.

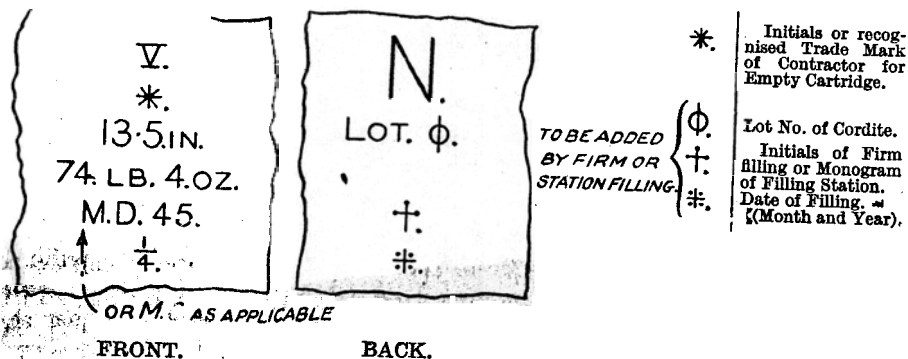

Face page 20.



GROUP OF B.L. CARTRIDGES.

(3) Cartridges for use with Stick Bombs in B.L. guns will be marked with the words "Stick Bomb" and the nature of the gun, contained in a rectangle.

The cartridges are marked as follows, on the opposite side :—

N. denoting the cartridge is for Naval Service.

The lot number of the cordite used, followed by "A.C." if the charge is adjusted.

Initials or monogram of filling station or the initials or trade mark of the filling firm.

The date of filling (month and year).

The hot storage mark or sub-lot marking, when applicable.

Note.—For the meaning of "Hot Storage Mark" or sub-lot marking, see Naval Cordite Regulations.

In future the letters "A.C." will not be shown.

Markings on igniters.

Igniters of standard type (parallel stitching) are marked as follows :—

Contractors' initials or Government mark.

Calibre of gun.

Letters "I.G." followed by a letter denoting the pattern of igniter.

Igniters of older design (radiating stitching) are marked with the following :—

Mark of igniter.

Initials of factory.

Nature of gun.

Weight of charge;

and below

Weight and nature of powder used in igniter.

For cases and methods of packing used for B.L. charges, see Chapter VIII.

Markings on cases for B.L. charges.

Designating letter and mark of case are stamped on the lid or top of the case.

Cases are painted stone colour, with two red bands denoting Naval—Service—Explosives.

Rectangular cases are marked on front ends. Cylindrical cases are marked on both ends and on the sides.

The following markings are found :—

Number of cartridges in the case.

Nature of the gun.

Weight of charge.

Mark of charge.

Nature of cordite.

Size of cordite.

Lot number of cordite, followed by "A.C." if the charge is adjusted.

Date of filling of the case and monogram of station.
 Nature of charge (*i.e.*, full, reduced, $\frac{1}{2}$ charge, &c.).
 Hot storage mark, where applicable.
 N. denoting Naval Service.

A blue diamond painted on the case indicates that the rosin oil was used as flux when soldering the cases (this being free from zinc chloride).

A raised metal star on the lid indicating charges for star shell only.

The following markings may be found stencilled on the sides of cylindrical cases for B.L. charges:—

REP^d & REPrd: Denoting that it contains cartridges which have been returned from a ship, repaired and put into a new case because the original one was damaged. The above abbreviations would be followed by the initials of the filling station and the date when the case was refilled.

I.N.S. ANNⁱ EXAMⁿ:—Denotes that it contains cartridges which have been examined by the I.N.O. from store, of which he takes account annually. The above abbreviations would be followed by the initials of the station where the examination took place and the date.

EXD. Indicates that the package has been opened at a depôt but not submitted for I.N.O.'s inspection.

REMADE.—This denotes that it contains cartridges which have been broken down and remade, using a new cartridge bag.

The above would be followed by the initials of the filling station and the date.

The L. Mark I cylindrical case if used for the 13·5-inch V “light” gun, has one hand-grip on the lid painted blue and the word **LIGHT** stencilled on one of the red bands.

L. Marks I and III cylindrical case is used for the 13·5-inch “Heavy” gun and has the word **HEAVY** stencilled on one of the red bands.

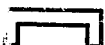
L. & Q cylindrical cases contain a wooden stool or packing piece to fill up the space. This is indicated by a symbol  coloured red.

Labels.

All packages containing Government Explosives have the following labels attached to them, *viz.*, “Station” label, “Government Explosive” label, and “Group and Division” label (or a combined “Group” and “Government Explosive” label in lieu of the last two).

Station Label.—This is a white linen label with two parallel black stripes between which is placed the Station Monogram. This label is placed on the box, as a seal, covering the joint between the lid and body, or over a hasp. It is put on the box at the packing or repacking station to indicate the station at which the package was sealed. Whilst the label is intact the contents may be accepted as correct.

Typical "Station" Label:—Showing initials of the packing station, e.g., "BC" signifies "Blackness Castle." These labels are pasted over the junction of the lid or bung and body, or over the hasp in the case of 3 and 6-pdr. cartridge boxes, so that they will be broken if the package is opened.

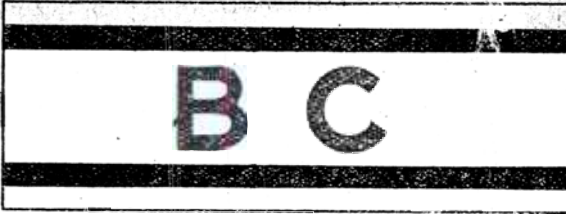

A new method of sealing boxes is now fitted where possible. This is designed to be a better safeguard against tampering with cases in transit from depôts to ships than the linen label.

The device consists of a spring seal with cup attached. The tapes or wires that seal the box are knotted in such a way that the knot is embedded in the sealing material in the cup. If tampered with it is impossible to restore the spring seal to its original condition. The spring seal takes the place of the station monogram linen label.

The question of efficient sealing of cases is, however, still under consideration, and the problem is simplified by the introduction of non-venting lids.

Government Explosive Label.—The Board of Trade limits the size of packages used for public conveyance of explosives, but such limit does not apply to Government Ammunition stores. Therefore, such stores are to be marked by a label to indicate that they contain Government explosives. This label is of white linen with the words "Government Explosive" in red within two red circles.

The "Station" label must always be used as a seal, i.e., placed over the junction of the lid and body.

"Government Explosives" Label:—Placed on all packages containing Government explosives. In future, however, a composite Group and Division and Government Explosives label will be used.



Group and Division Label.—This label is to denote the group and division (according to Appendix IV of the Magazine and Explosives Regulations) in which the package is to be stored. It must not be used as a seal, but placed so that it is visible when the package is stacked.

The label has a red symbol on a white ground for Naval Service packages. The symbols are a "disc," "diamond," "triangle," and "square," in red, for groups I, II, III and IV respectively. The division of the group is indicated by a figure in white within the symbol. The label is of paper.

The grouping of explosives is being altered and they will in future be divided into fourteen groups without divisions in each group.

**TYPICAL "GROUP" AND "DIVISION" LABELS
DENOTING THE CLASSIFICATION OF EXPLOSIVES FOR
STORAGE AND TRANSPORT.**

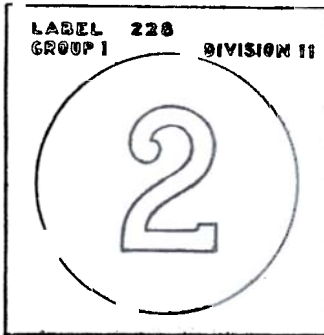

The symbol signifies the number of the group, & the figure thereon the number of the division in the group. In future however the labels as shown will be used



Combined Group and Government Explosive Label.—This type of label has been used during the war and will be used in future pending introduction of the new classification referred to hereafter. It consists of the "Government Explosive" label and the "Group and Division" label combined into one label, now made of paper. In this case the words "Government Explosive" are arranged round the symbol, on which is placed the "Broad Arrow." This has been used as a seal but in future it is not to be so employed.



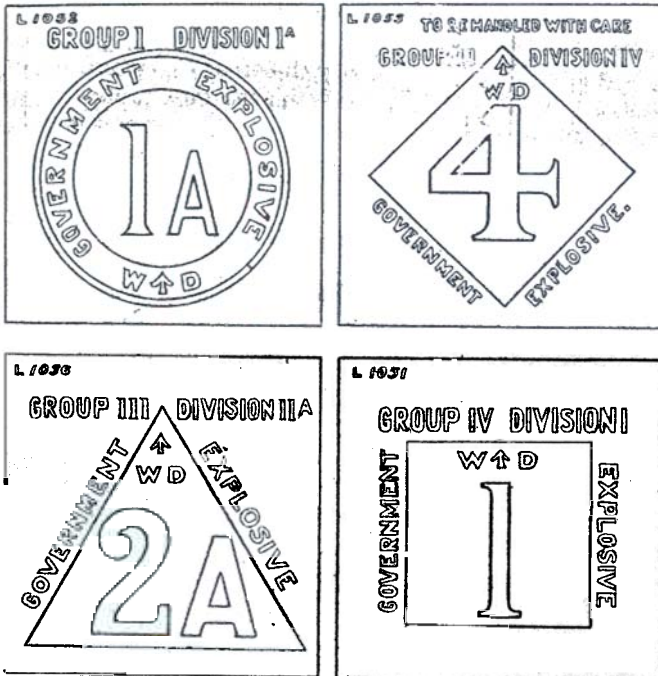

The following alterations in the "Government Explosive" label and the "Group and Division" label are being introduced, and will ultimately take effect on the boxes found afloat. The new "Grouping" abolishes the "Divisions," and came into force in depôts and factories 1.1.23.

A "Station Monogram label" or an "Inspection Department label" will be pasted over the junction of the lid and body to form a seal, as at present.

A composite label, denoting Government Explosive and the Group Classification of the explosive, will take the place of the labels described above. This composite label will not be used as a "Seal," but will be pasted on in any convenient position on the box.

For general purposes the composite label will be painted in red on a white ground.

Examples of the new composite labels are given. When the number appears as a fraction it indicates that the explosive is classified for general purposes under the group number given in the numerator and is classified specially for purposes of stowage on board H.M. Ships under the group in the denominator.

In the example shown the explosive belongs to group 2, but is classified in group 8 for storage on board H.M. Ships (See specimen labels as shown, facing this page.)

These new labels will gradually supersede the "Government Explosive," "Group and Division," also the combined "Group and Division and Explosive" labels at present in use.

CHAPTER V.

CARTRIDGES FOR Q.F. GUNS.

Section A.

A Q.F. gun, as regards its ammunition, differs from a B.L. gun in having its charge and the means of ignition of the charge contained in a brass case, which also acts as an obturator.

Q.F. guns are divided into two classes, viz. :—

- (1) those which fire “**Fixed Ammunition**,”
- (2) those which fire “**Separate Ammunition**.”

With “**Fixed Ammunition**” the projectile is secured in the mouth of the brass cartridge case, the projectile and charge being loaded in one operation.

With “**Separate Ammunition**,” the projectile is not attached to the cartridge case, but is packed and loaded separately.

Table 3 shows the type of ammunition fired by the various natures of Q.F. guns, and also the means of ignition employed.

Q.F. cartridge cases.—All Q.F. cartridge cases are made of brass, solid drawn, and coned to the front to facilitate loading and extraction.

A flange is formed at the rear end to prevent the case being forced too far into the gun chamber, and to facilitate extraction. The flanges of all Q.F. cases containing the special reduced charges for use with star shell are milled, as a means of identification at night.

All Q.F. cases are lacquered internally with transparent lacquer to prevent deterioration.

Cases for the following guns are lacquered both internally and externally :—

- 13-pdr.
- 12-pdr. 12, 8 and 4 cwt.
- 6-pdr.
- 3-pdr.
- 2-pdr.
- 1-pdr.

Three tongues are cut in the mouths of cases used for separate ammunition as a means of securing the lid (*see* under Lids Q.F. Cartridge).

Fired Q.F. cases.—As soon after firing as possible the adapters, percussion primers, &c., are to be removed from Q.F. cases. The cases should be cleaned with hot water and soda and slightly lubricated with mineral jelly. They should be returned to the Armament Supply Depôt in their proper boxes.

These cases can be rectified and refilled for use some five or six times, unless condemned through some defect appearing during the rectifying process. This latter consists of annealing the case, knocking out the indents and generally restoring it to its original shape.

The history of a case can be read from the markings stamp on its base. (See page 34.)

The removed adapters or primers are to be returned in separate boxes from the empty Q.F. cases.

CLIP, CARTRIDGE, Q.F., 6-PR., MARK III | c |.

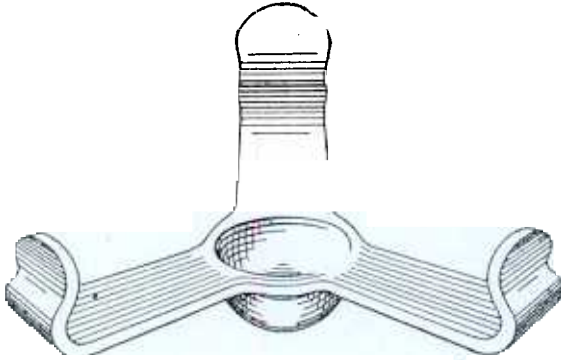

Clips, Q.F. cartridge.—Q.F. ammunition fitted with primers percussion and percussion caps are supplied with brass three-arm spring clips with central boss. The clips fit over the flange of the cartridge case and the boss protects the cap from being fired accidentally by a blow during transport and handling.

Cartridge clips are removed before loading and are not supplied with ammunition fitted with adapters, since, with this type of ammunition, the means of ignition, *i.e.*, the V.S. tube, is supplied separately.

Q.F. 2-pdr. rounds supplied in belts are not fitted with clips. During the war, steel clips were manufactured and issued, but no more are to be made.

Lids, Q.F. cartridge.—In Q.F. separate loading cartridges, the mouth of the cartridge case is closed by means of a circular white metal lid fitted with a flange and with three slots cut in the rim.

The lid is secured to the mouth of the case by bending over the tongues of the case into the slots in the lid. The joint between the flange of the lid and the case is sealed with Pettman cement.

There are two types of cartridge lids :—

(1) For cartridges for use with tracer projectiles.—A typical lid of this nature is shown in (Plate 3). The lid consists of a corrugated disc of white metal, perforated in the centre, and weakened by a number of radial slits. The outer portion is flanged, so as to form a lip to rest on the

mouth of the cartridge case. Three notches are cut in the rim to take the tongues of the cartridge case. To the upper face of the disc is soldered a corrugated ring of white metal which tends to strengthen the lid.

The central hole is closed by means of a disc of batiste (waterproofed cambric) and a disc of paper secured to the under side of the lid by shellac. The object of the central hole is to ensure that, when the cartridge is fired, there may be a free passage from the charge to the tracer.

(2) **For cartridges not used with tracer projectiles.**—This type of lid, shown in Plate 3, is concave and consists of two discs of white metal soldered together, the space between these discs being filled up with a perforated strawboard disc. The strawboard disc tends to strengthen the lid and the perforations are intended to allow the gas pressure free access to the pressure plate of a base fuze when the cartridge is fired.

To enable the lid to break up easily, it is weakened by means of radial and concentric grooves.

Three notches are cut in the rim of the lid to take the tongues on the mouth of the cartridge case.

In future all cartridges, except those for use in 12-pdr. 4-cwt. gun, will be fitted with lids of type (1).

Wads, felt.—Felt wads are used in Q.F. separate loading cartridges to fill up the space between the top of the cordite charge and the underside of the metal lid.

The underside of the wad next to the cordite is covered with a glazed board disc, sewn to the felt, so that the cordite is not in direct contact with the felt, which might absorb exudations from the cordite. Felt wads and glazed board discs supplied with cartridges for use with tracer projectiles have a central perforation, 1·4-inch in diameter, into which is secured a paper cylinder. The projecting end of the paper cylinder fits into the upper end of the cordite charge and is intended to allow a free passage for the gases from the fired charge.

Discs, centring, are discs of glazed board, ·05-inch thick, slit in the centre so as to pass over the cordite charge. They are intended to keep the charge central in the case. Small bundles of short lengths of cordite—known as “fins”—fixed at right angles to the main charge and to each other have been used in certain 6- and 3-pdr. cartridges for centring purposes.

Distance pieces and paper cylinders.—Distance pieces in the form of cylinders of millboard are sometimes used to fill up space in a cartridge case containing a reduced charge. As it is desirable, however, not to use substances which may cause debris in the gun after firing, distance pieces have been avoided as far as possible in the more recent designs of cartridges.

WHITE METAL LID, MARK I. |N|. FOR
CARTRIDGE Q. F. 12 PR 4 CWT.

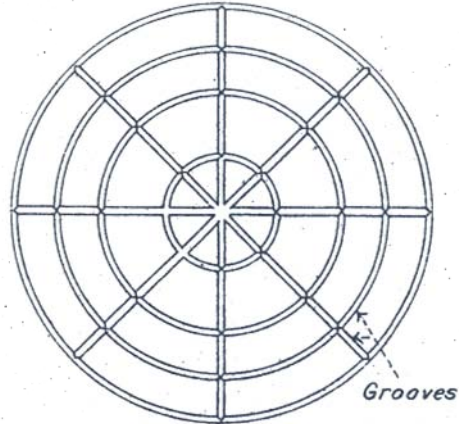

UNDER DISC OF LID.

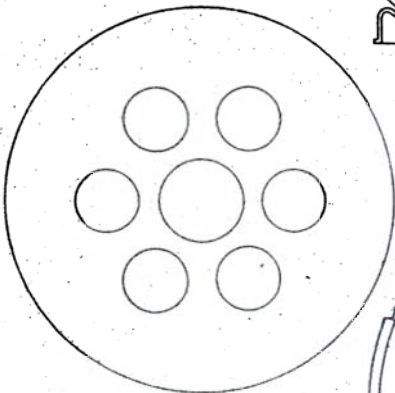
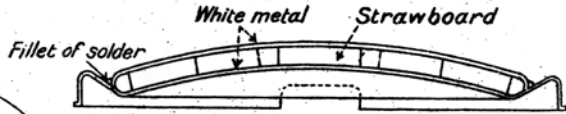
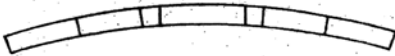

STRAWBOARD DISC.

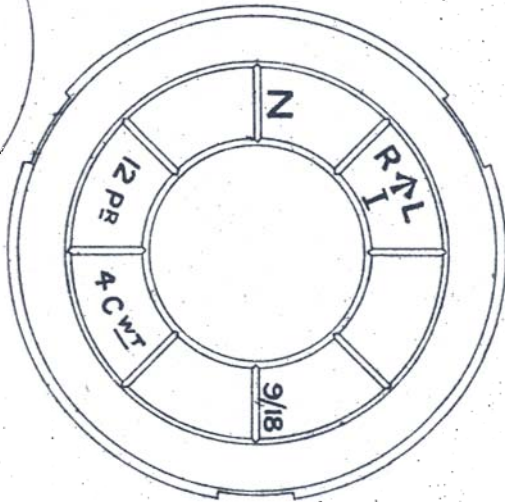

Paper cylinders are used with perforated wads in cartridges for tracer projectiles and are fitted round external tracers in fixed ammunition.

Cordite charges for Q.F. guns.—The methods of make up of charges for Q.F. guns vary considerably, being governed by the weight of charge and the length of the cordite sticks supplied. Methods, which may be taken as more or less typical, are explained in detail in sections B. and C.

All silk sewing used for tying Q.F. charges is greased with mineral jelly before use.

All Q.F. charges, 12-pdr. and above, and 3-pdr. Vickers', are adjusted.

Inspection of lids of Q.F. cartridges. (Separate ammunition).—If a lid is loose the momentum of the lid and charge may cause them to travel forward into the chamber when the cartridge case takes its seating in the gun and is brought to rest. This may withdraw the charge and igniter from the tube or primer and cause a failure to ignite the charge (missfire), or a dangerous "hang fire" owing to the flash of the tube or primer causing the igniter bag to smoulder instead of exploding the powder at once. Hang fires of as much as 24 minutes have been attributed to that cause. To guard against this, the lids of all separate loading Q.F. cartridges are to be inspected before firing, to see that they are firmly fixed in the mouth of the cartridge case.

Section B. Q.F. fixed ammunition.

As explained previously, a Q.F. fixed ammunition round has the projectile fixed in the mouth of the cartridge case.

The method of securing the case to the shell for all fixed ammunition except 13-pdr. is as follows :—

All fixed ammunition projectiles have a cannellure to the rear of the driving band. The portion of the projectile to the rear of the driving band is coated with Pettman cement and is pressed into the mouth of the cartridge case until the mouth of the case meets the rear end of the driving band. The case is then indented, by means of an indenting machine, into the cannellure in the projectile.

2-pdr. ammunition is indented all round the case, 6-pdr., 3-pdr., and 1-pdr. projectiles are secured with 3 indents, 3-inch 20-cwt. and 4-inch Mark IV gun with 4 indents, 4-inch Mark V and V* guns with 8 indents.

13-pdr. projectiles are not fitted with a cannellure, but have a groove cut in the rear portion of the driving band. The case is not, therefore, indented into the projectile, but the lip of the case is pressed into the groove. Up to the present shellac has been used instead of Pettman cement for 1-pdr., 3-pdr., and 6-pdr. rounds, but Pettman cement will be used for all fixed ammunition in future.

METAL IGNITER AND ADAPTER.

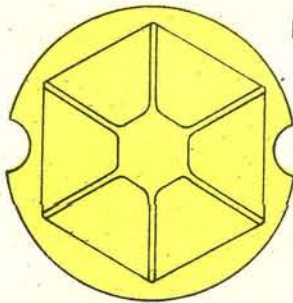

PLAN CLOSED.

BEFORE CLOSING

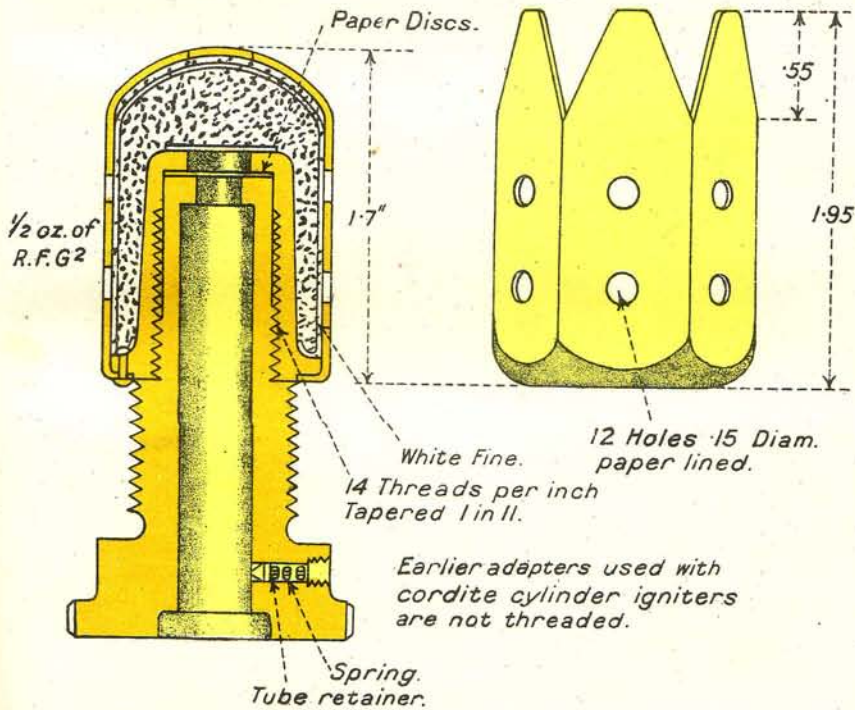

Section C. Q.F. separate loading cartridges.

A Q.F. separate loading cartridge consists of cartridge case, percussion primer (or adapter and metal igniter) charge, wad or wads, with or without paper cylinder, white metal lid and cartridge clip (for primered cartridges). Some cartridges fitted with primer percussion have, in addition, a small igniter, consisting of a shalloon bag filled with R.F.G.² powder, secured to the rear end of the cordite charge. (For details of cartridge case, lid, wad, paper cylinder and clip, see Section A.)

Section D. Adapters and percussion primers.

Adapters (Plate 4).—The Marks IV, IV*, V and VI are those generally met with.

The Mark IV is made of aluminium bronze and bored out to take a tube. The Mark IV* and Mark V have a small pin point plunger at the side, kept up to its work by a small spring shown in the section, which forms a tube retainer. They are threaded on the outside and screwed into the base of the cartridge case; the front end is coned, and closed by a paper disc, which is shellaced on and painted over with Pettman cement to prevent the ingress of damp into the cartridge.

The Mark VI is similar except that the front portion is threaded to take a metal igniter.

All primers and adapters are to be inserted with luting under the flange.

Igniters (Plate 4).—In cartridges fitted with Mark VI adapters a hexagonal case of thin metal containing R.F.G.² is screwed on to the front of the adapter to form an igniter. This type is referred to as the metal igniter.

In earlier Q.F. cartridges fitted with adapters the igniter consisted of R.F.G.² in a shalloon bag fitted in a cylinder of cordite. This is held to the body of the charge by shalloon braid and is so placed as to fit over the adapter.

Percussion primers.—Primers, percussion, No. 1, Mark II, are used in the cartridges of Q.F. 13-pdr. 4-inch Marks IV, V, V*, VII, and XII, 12-pdr. 4-cwt. and 3-inch 20-cwt. guns.

A No. 1. Mark II primer consists of the following components:—

Body, percussion cap, anvil plug, copper ball, screw plug and brass closing disc.

The body is made of metal and is formed with a flanged head; a portion of the body is threaded externally to screw into the base of the cartridge case. Two key slots are cut in the head.

The interior of the primer is bored out and screwed as necessary for the reception of the cap, anvil, and screw plug, and the fore end is cupped to accommodate the powder which forms the magazine.

The cap, which is made of copper and filled with cap composition, is placed in the recess in the body, after having been first coated externally with Pettman cement. An annular ring

of cement is also formed between the body and the cap to prevent ingress of damp.

The anvil, which is of high class metal, is screwed in from the front; the copper ball is placed in it, and the metal screw plug which retains the anvil and ball in place is screwed down on top of the former.

The anvil has three fire holes perforated in it through which the flash from the cap passes.

The screw plug also has three fire holes bored in it to allow the flash from the cap to pass through and ignite the magazine.

The magazine is filled with R.F.G.² powder, and the brass closing disc is placed over the top of the magazine and retained in place by turning over the edge of the primer on to the disc.

This brass closing disc has six radial slits cut in it, so that on firing the cut portions of the disc open outwards while the disc itself remains attached to the primer. A paper disc is secured with Pettman cement to the underside of the brass closing disc.

In order to prevent any powder finding its way through the fire holes of the screw plug to the interior of the anvil, a paper capsule is placed over the conical portion of the primer body.

The function of the copper ball is to prevent pressure from the gases, formed by the explosion of the magazine and charge, being exerted on to the interior of the cap.

The outside of the brass closing disc and the joint between the closing disc and the primer are coated with Pettman cement as a protection against damp.

Primer percussion No. 2, Mark IV, is used with 3-pdr. and 6-pdr. Q.F. ammunition, in such cartridge cases as are designed to take them, *i.e.*, the latest makes of cartridge cases which are constructed with thicker bases.

The primer consists of the following parts:—Body, percussion cap, anvil, copper ball, perforated brass disc, and magazine.

The body, which is of metal, has a flange formed at the head in which two key slots are cut, and the remainder is threaded externally to screw into the base of the cartridge case. Internally the body is recessed for the reception of the cap, and screwed on two diameters to take the anvil and magazine respectively.

The cap is made of brass and filled with cap composition. It is inserted into the recess formed for it in the body, after being coated externally with Pettman cement, and, after insertion, a fillet of Pettman cement is formed between the body and the cap as a protection against ingress of damp.

The anvil, which is of high class metal, is screwed into the body and the copper ball inserted.

The magazine consists of a brass cylinder screw threaded externally at the rear end, perforated with eight fire holes, and filled with a perforated powder pellet wrapped in white fine paper.

The front end of the magazine is tapered externally and the rear end screwed internally for the reception of the perforated

brass disc. A paper disc is secured with shellac to the outside of the brass disc.

The magazine, complete with disc, paper lining, and filling is screwed into the front end of the body, and is prevented from unscrewing by three punch dabs.

The anvil and brass disc are perforated each with three fire holes to allow the flash from the cap to reach the magazine, and the copper ball acts as a seal against pressures exerted by the gases formed from the explosion of the magazine and charge.

In some primers of this Mark, the screw threading of the brass disc and the internal screw threading of the magazine have been omitted.

Primer percussion No. 2, Mark III, is used in 6-pdr. and 3-pdr. cases which were originally fitted with a percussion cap and subsequently converted to take a percussion primer.

There is some liability for these primers to blow out, as the base of the cartridge case, having been originally made to take a percussion cap, is not sufficiently strong to ensure the primers always being held in place.

The body differs from that of the Mark IV primer in that the flanged portion is screw threaded, the remainder of the external portion of the body remaining plain.

A gas check is formed on the front end of the body.

A special type of anvil plug is fitted which is perforated with two fire holes only, and no ball seal is provided.

The magazine is similar to that of primer percussion No. 2, Mark IV, but is smaller in diameter and of greater length, and contains two perforated powder pellets.

Primer percussion No. 2, Mark V, is similar to primer percussion, No. 2, Mark III, except that the fore end of the magazine is not tapered to a point but cut off square with the magazine body. The anvil also is of slightly different shape.

Primer percussion No. 2, Mark VI (Plate 32), is similar to primer No. 2, Mark IV, from which it only differs in respect of the magazine, which is identical with that of the primer No. 2, Mark V.

Primer percussion No. 5, Mark I, is used in 2-pdr. ammunition, and is similar to, but smaller than, primer percussion No. 1, Mark II. It is not, however, fitted with a ball seal, and has therefore no plug above the anvil.

Some primers percussion No. 5 are fitted with a special form of steel closing disc, and these are known as primer percussion No. 5 S, Mark I.

Section E. Keys, &c., for use with Q.F. cartridges.

The following keys are supplied for Q.F. guns.

(1) **Cartridge holder**.—This is shown in the accompanying sketch. It is used to hold the case when the adapter is being unscrewed.

PRIMER. PERCUSSION, Q. F. CARTRIDGES, No 2, MARK VI.

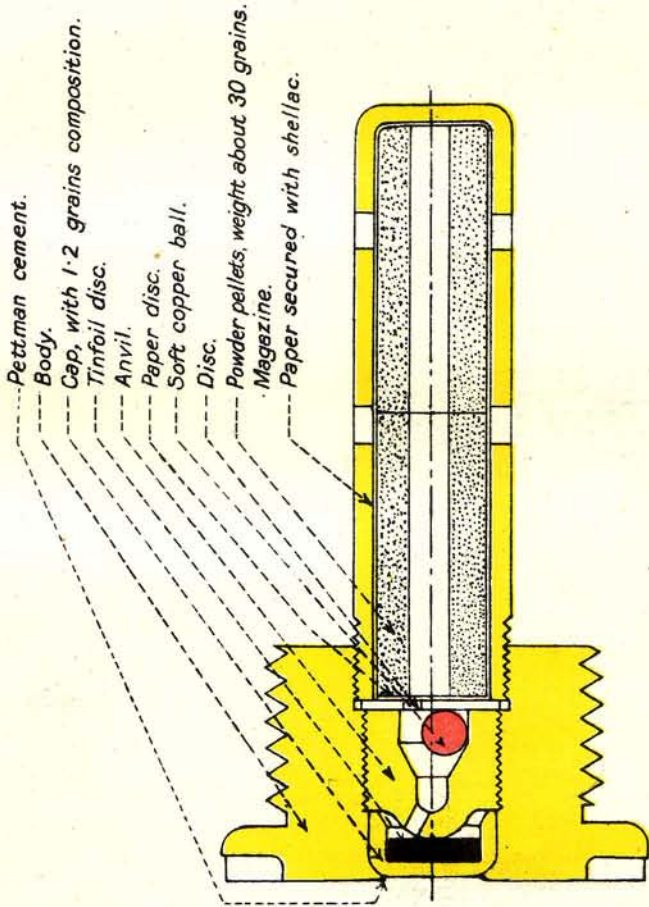

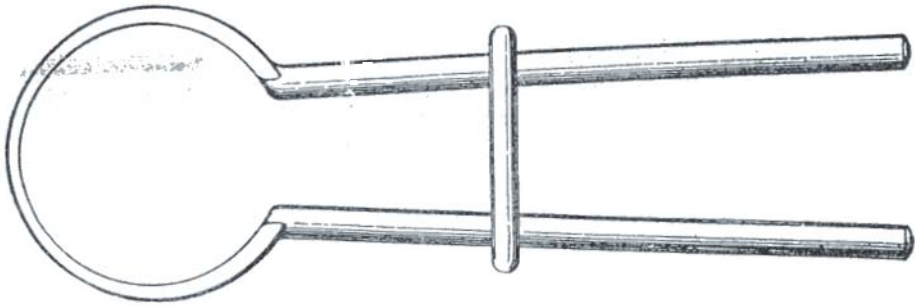

No. 24 key.—This T-handled key, shown below inserting adapter

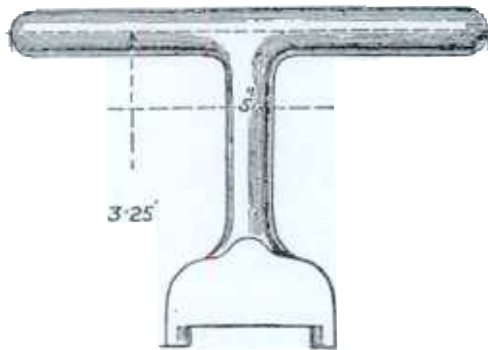

No. key. This wrench removing adapters
Sketch below

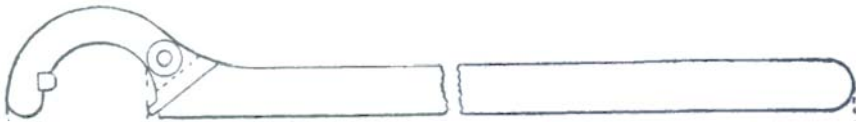

15

Implement for opening Q.F. cases. This used when inserting crusher gauges or when breaking down charges

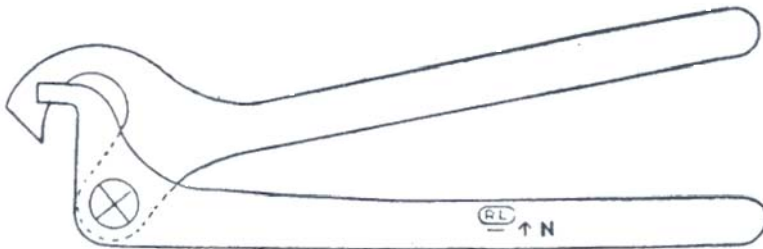

(5) No. 27 key.—A flat key, as shown below, used for inserting and removing primers of 13-pdr. ammunition.

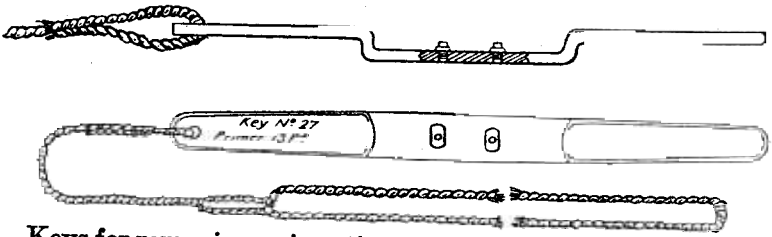

Keys for removing or inserting primers from other Q.F. ammunition are similar, but of different sizes.

Section F. Markings and packing of Q.F. Ammunition.

The following markings are stamped on the base of Q.F. cartridges (Fig. 1):—

1. Nature and mark of gun.
2. Mark of empty case.
3. Year of manufacture, and often the month.
4. Trade mark (or initials) of maker of the case.
5. Lot number of batch of cases as manufactured.
6. Date of acceptance. (On cases accepted by Army Inspectors only.)
7. ★ following the mark of case, denoting either (i) that the lid was originally closed by three lips, but that the case has been converted to hold the lid with six lips, or (ii) that the primer hole has been rebushed or converted from a cap recess (6 and 3-pdr.).
8. ↑ Denoting that the case is accepted for service.
9. N, denoting Naval Service.
10. Monogram or initials of the repairing station, followed by a number indicating the series or batch.
11. (A)• followed by a punch mark:—•, denoting that the case has been annealed after firing. Any subsequent annealing is denoted by an additional punch mark.
12. A letter underneath the (A)•, indicating the year in which the case was annealed.
13. (X)•, which is the stamp referred to at (11) impressed twice, the second time reversed, denoting that the case has been "low temperature" annealed.
14. (S)• followed by a punch mark:—•, indicating that the case has passed the scleroscope test, an additional punch mark being added for each subsequent scleroscoping.
15. P, followed by a dash or dot, indicating that the case has been used for a powder charge.
16. C, denoting cordite filled; followed by

17. F, for every full charge with which the case has been filled, and
18. R, for every reduced charge.
19. \overline{R} or \overline{F} , denoting that the charge has been removed and not fired
20. \uparrow under the symbols at (17), (18) or (19), indicating that the case has passed inspection, after repair, following the firing or withdrawal of the charge.
21. \otimes , denoting that the case has been condemned.
22. G, denoting allocation to Gunnery Schools.
23. \uparrow (E) 1, denoting that the case has been accepted with reduced life, but without special allocation, the figure indicating the number of Service rounds permissible.
24. H, denoting that the case has been headed under a hammer.
25. (1), on 6-pdr. and 3-pdr. cases, denoting that the case is fitted with a Mark II (thin) cap.
26. "R.C. only," denoting that the case is restricted for use with reduced charges.
27. "VICKERS," on all 3-pdr. Vickers cases.
28. G, on 6-pdr. and 3-pdr. cases, denoting that the case is restricted to reduced charges.

Note.—(i) Additional markings may be found, such as small private marks.

(ii) On large numbers of small cases, the stampings will be found incorrectly placed, owing to increased output and lack of experienced labour during the war.

(iii) Of the above list, only a certain number of stampings appropriate to the particular case, will be found in any one cartridge.

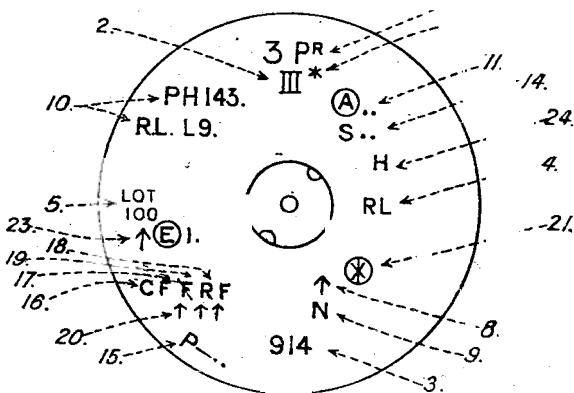

The following markings are stencilled in black across the base of Q.F. cartridges (Fig. 2) :-

1. Lot number of cordite, also sub lot where applicable.
2. Weight of charge (except for 3-pdr. and below).
3. Mark of cartridge.

4. Monogram or initials of the filling station.
5. Date of filling (month and year).
6. "RED^d," denoting "Reduced Charge," where applicable.
7. "BLANK," where applicable.

In addition, for separate loading ammunition, the same details are printed in black on a label affixed in the lid recess.

Cartridges for use with Stick Bombs are marked with a blue cross on the base of the case.

Cartridges are still in the Service stencilled and labelled by an older method, as illustrated in Fig. 3.

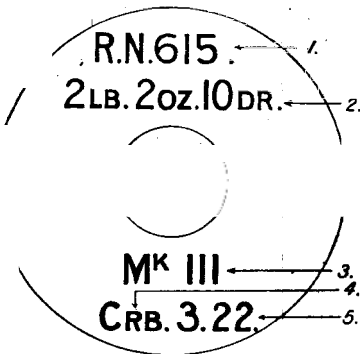

FIG. 2.
Q.F. AMMUNITION 3-INCH AND ABOVE.

STENCILLING IN BLACK ON BASE OF CARTRIDGE CASE.

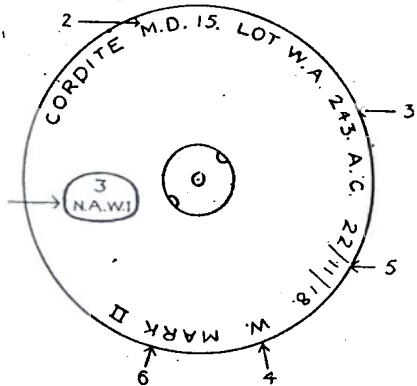

FIG. 3.
STENCILLED MARKS ON THE BASE OF Q.F. CARTRIDGE CASES.

1. Hot storage mark (when applicable).
2. Nature and size of cordite.
3. Lot number of cordite followed by A.C. if an adjusted charge.
4. Initial or monogram of filling station, or trade mark or initials of the firm filling the case.
5. Date of filling (month and year).
6. Mark of cartridge.

Q.F. Ammunition above 3-pdr. :—

(1) For future supplies of Q.F. Separate Loading and Fixed Ammunition cartridges, the stencilling on the base will be as shown. (Fig. 4).

(2). In addition for separate loading ammunition, details will be shown on a label affixed in the lid recess.

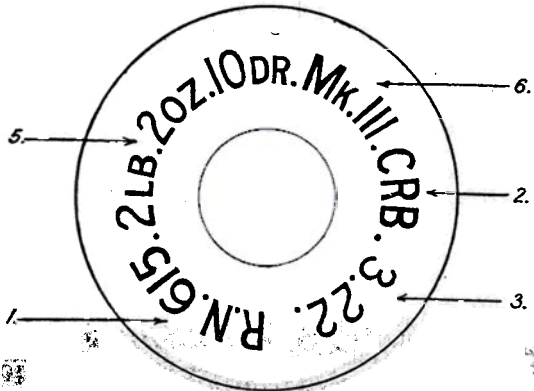
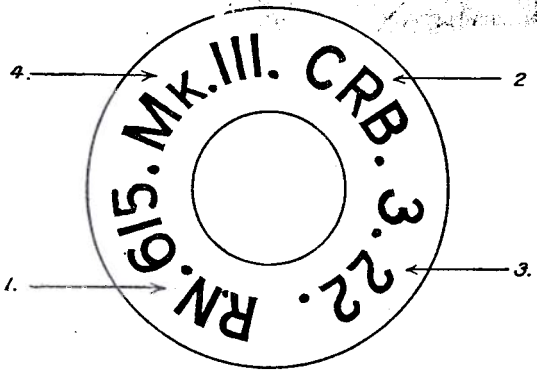

FIG. 4.
Q.F. AMMUNITION ABOVE 3-PDR. AND BELOW 3-INCH, STENCILLING IN BLACK ON BASE OF CARTRIDGE CASE

1. Lot No. of cordite.
2. Monogram of firm or station filling.
3. Date of filling cartridge (month and year).
4. RED^d. (where applicable).
5. Weight of charge.
6. Mark of Cartridge.

Q.F. Cartridges 3-pdr. and below :—

(3). The stencilling on the base of cartridges will be similar except that the weight of the charge will be omitted. (Fig. 5).



1. Lot No. of cordite.
2. Monogram of firm or station filling.
3. Date of filling cartridge (month and year).
4. Mark of cartridge.

FIG. 5.
Q.F. AMMUNITION 3-PDR. AND BELOW.
STENCILLING IN BLACK ON BASE OF CARTRIDGE CASE.

Markings on adapters.—The following marks are stamped on the base of an adapter :—

1. Mark of the adapter.
2. N, denoting Naval Service.
3. ↑ denoting accepted for Service.
4. Manufacturer's initials.
5. Date of manufacture (month and year).
6. Contractor's initials or recognised trade mark.
7. Lot No.

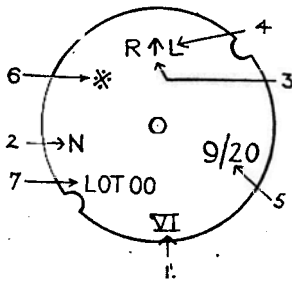

Markings on percussion primers :—

1. Serial number of primer.
2. Mark of primer.
3. N, denoting Naval Service.
4. ↑ denoting accepted for Service.
5. Initial or monogram of filling station, or trade mark or initials of firm filling the case.
6. Date of filling (month and year).
7. Lot number of primer.

8. Contractor's initials or recognised trade mark.
9. Date of manufacture (month and year).

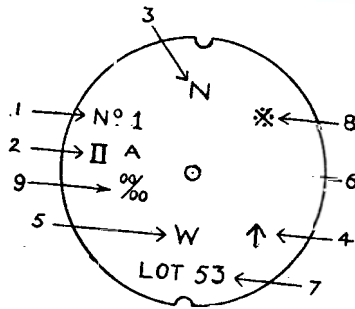

If a repaired and refitted primer is used the existing marking is to be ruled through.

After repair the following markings are added :—

1. R, after the mark of primer.
2. N, denoting Naval Service if not already so marked.
3. Contractor's initials or recognised trade mark of firm repairing.
4. Month and year of repair.
5. Lot number.
6. Contractor's initials or recognised trade mark or monogram of station refilling.
7. Month and year of refilling.

Markings on the lids of Q.F. cartridges :—

The following are stamped on lids of Q.F. cartridges :—

1. Mark of lid.
2. N, denoting Naval Service.
3. ↑ denoting accepted for Service.
4. Manufacturer's initials.
5. Date of manufacture (day, month and year).
6. Nature and sometimes mark of gun.

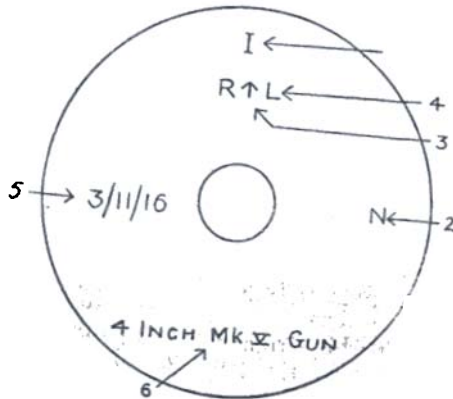

NEW TYPE LABEL.
UNIVERSAL.

Fig. II.



PRESENT LABEL.
AMENDED.

Fig. III.

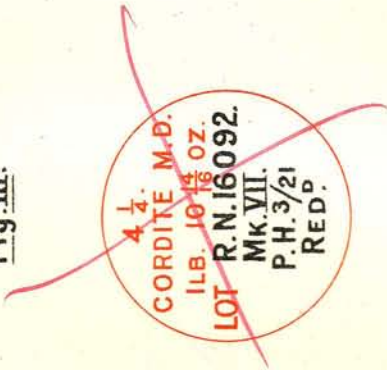

In future the Lid Labels will be as shown :- (Figs. II & III.)

Until supplies of the new labels become available, the size and nature of cordite will appear in addition as on the old labels (Fig. III.)

Contents label for separate Q.F. cartridges only.—The following details of the charge are printed in red on the contents label, which is attached to the lid recess in the centre, or on the bevel edge if there is no recess :—

1. Numeral of the filled cartridges.
2. Size of the cordite.
3. Nature of the charge.
4. Weight of the charge.
5. Lot number of the charge
6. Lot number of the cordite cylinder.

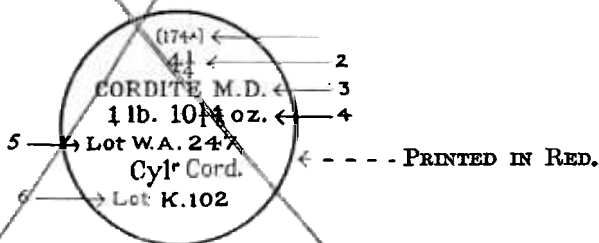

FIG. I.

NOTE.—In future the lid labels will be as shown :—Figs II. and III. opposite this page.

Ammunition for Q.F. guns is packed in ammunition boxes (*see* Chapter VIII). All boxes (except S.A.A. boxes) have two red bands painted round them to denote Naval Service. All boxes for Service ammunition are painted stone colour, except 3-pdr. (*see* page 41) and packages containing Target Smoke Ammunition which are marked green, with a yellow band to denote “practice.”

Markings on the lids of Q.F. ammunition boxes.

The following are stencilled on the lid in black :—

1. Number of cartridges in the box, followed by the words
2. CARTRIDGES Q.F.
3. Nature of the gun.
4. Weight of the charge. } And to have the letters “A.C.”
5. Mark of the charge. } when an adjusted charge is
6. Nature of the cordite. } used.
7. Size of the cordite.
8. Lot number of the cordite.
9. PRIMERS, followed by numeral and mark, manufacturer’s initials and dates, or
10. ADAPTERS, followed by numeral and mark.
11. IG, MET. or METAL IGNITER, if used, or
12. CYL. CORD., denoting cordite cylinder igniter, if used.
13. Lot number of the cordite cylinder igniter, if used.
14. FILLED, denoting that the ammunition box is filled.
15. Initials or monogram of the filling station.

16. Date of filling of the box.
17. Serial number of the box.
18. N, denoting Naval Service.
19. For "Gunnery School only"—"Not for use Sub-calibre guns" will be stencilled on the lid where applicable.
20. \widehat{T} . lids, if designed, to be fired with night tracer.

Information as to the cartridge cases as follows:—

21. CASES, refers to the cartridge cases.
22. Manufacturer's initials.
23. Date of manufacture of the cartridge cases.
24. \otimes or \textcircled{A} denotes that the cartridge cases have been repaired and annealed.
25. REPD. denotes that the cartridge cases have been repaired and not annealed.
26. \textcircled{S} denotes that the cases have passed the scleroscope test.

Information as to lids of cartridge cases as follows:—

27. S. LIDS, denotes lids with strawboard insertion, or
28. LIDS MK I, denotes the mark of lid.
29. \bullet ($\frac{1}{2}$ -inch diameter) denotes a circular hole in underside of lid.
30. \smile denotes dished lids with several holes in strawboard. On boxes containing star shell ammunition only.
31. M. \star R. denotes Q.F. charges for star shell only, the cartridge cases of which have milled rims.
32. Raised brass stars on the lid denote star shell charges (one on metal cases, two on wood boxes) to facilitate recognition at night.
33. $\textcircled{S.P.}$ may be found on older boxes denoting that igniters are of sulphurless powder.
34. Hot storage mark will be found when applicable.

The following may be found on the side of the box:—

1. Contents label. A paper label giving the contents of the box.
2. LACQUERED INTERNALLY. When the cylinders have been so treated.
3. C. Denoting that there is a copper lining to the box.
4. FOR REDUCED PRACTICE. When the boxes contain special charges of the above description.
5. Boxes and cases containing cartridges for use with star shell will have a 3-inch six-pointed star stencilled (same colour as other markings) on all four sides and lid.

Painted on the cleat under the handle.

6. EXD. Denoting that the handle has been examined and may be used for lifting the box.
7. Initials of the station where handle was examined.
8. Date when handle was examined.

Boxes containing fixed ammunition, in addition to those of the above which are appropriate, are also marked FUZED (or refused), monogram of station and date (day, month and year) of fuzing, with the nature of the projectile and the type or numeral and mark of the fuze.

Labels.

A label giving the packer's name, and place and date of packing, is to be placed inside the package, and a station label, consisting of a strip of muslin, about 3 inches by $1\frac{1}{4}$ inches, with the initials of the packing station in black, is to be pasted over the junction of the lid (or bung) and the body of all packages of cartridges, except in the case of 3 and 6-pdr., when it will be placed over the hasp of the box. The group and station label are also to be placed on each package, the latter being pasted over the junction of the lid and body, so that it must be torn if the lid is opened. This does not apply to labels on "L" Marks I and III and "N" Mark I cases, where the station label will be pasted over the ends of the closing tape, and the explosive label in any convenient position. These labels are to be attached so as not to obscure any stencilling on the packages.

Boxes for 3 and 6-pdr. ammunition.

Ammunition for 3 and 6-pdr. Q.F. guns is packed in special boxes (*see* Chapter VIII.).

Boxes are coloured as follows :—

6-pdr. Hotchkiss (except H.E.)	...	Stone colour.
3-pdr. Hotchkiss or Vickers (except H.E.)	French Grey.
H.E. (Hotchkiss or Vickers)	Yellow.
Practice (Hotchkiss or Vickers)	Yellow lid.
Drill or Dummy (Hotchkiss or Vickers)	...	Black.

If the projectile is a plugged shell annealed for use as a practice, SHELLS A is to be found on the lid.

If the ammunition is suitable for use in sub-calibre guns the words, SUB-CAL are also found on the lid.

3-pdr. Vickers and 3-pdr. Hotchkiss can be readily differentiated because Vickers boxes have the hasp on the top, while Hotchkiss boxes have the hasp on the side.

Boxes containing 6 and 3-pdr. cartridges have the following information on them :—

(A) Stencilled on the lid.

(i) Hotchkiss cartridges.

(A) Number and designation of cartridges.

In addition, boxes containing Q.F. ammunition have a label showing the contents affixed on the outside of the package. All packages of future manufacture not protected by battens will be provided with a recess for this label.

A.F.O. 1712/1928.

- (B) Mark and the word "Fuzed" or "Plugged" (as the case may be).
 - (C) Weight of charge, "Cordite," and "Lot No."
 - (D) Cases' manufacturer's initials and date "Primers," and manufacturer's initials and numerals of same, or "Caps Mark." If annealed shells are used, letter A is also stencilled.
 - (E) "Fuzes, Hotchkiss Mark —" (for Service cartridges only).
 - (F) Monogram of station and date of filling. Also series number.
 - (G) "For Gunnery Schools only" in the case of 3-pdr. cartridges made up with cases specially sentenced for such uses.
 - (H) Mark of igniter.
- (ii) 3-pdr. Vickers cartridges.
- (A) Number and designation of cartridge.
 - (B) "Vickers Mark —" and word "Fuzed" or "Practice" (as the case may be).
 - (C) "Full" or "Reduced charge," as the case may be, for boxes containing practice ammunition.
 - (D) Weight of charge "Cordite" and "Lot No."
 - (E) Cases' manufacturer's initials and date, "Primers" and manufacturer's initials and numerals of same, or "Caps Mark." Also A if shells are annealed.
 - (F) "Fuzes, Hotchkiss Mark —" (For Service cartridges only).
 - (G) Monogram of station and date of filling. Also series number.
 - (H) "For Gunnery Schools" only if made up with cases specially sentenced for use with reduced charges.
 - (K) Mark of igniter.
- (B) Stencilled on front cleat :—Number of box.
- (C) Inside of lid :—A descriptive label containing all information stencilled on the top of the box.
- (D) On outside of box, under front cleat :—Full descriptive label as in (C).
- For junction of lid and front box :—"Station" label.
- On back of box :—"Group and Division" label.
- On side of box :—"Government Explosives" label in any convenient position.
- (E) On inside of lid and on the front of the box outside, of boxes containing cartridges which have been re-indented, a manuscript label, as below, is to be pasted :—
- Re-indented.
 - Station.
 - Date.

CHAPTER VI.

TUBES.

Tubes are used for igniting the charges of :—

- (A) B.L. guns.
- (B) Q.F. guns where the cartridge cases are fitted with adapters and not for primers.

The satisfactory action of tubes is of the greatest importance, since not only does accuracy of shooting depend to a large extent upon this, but also the whole fighting efficiency of the Fleet.

Two types of tubes are used for firing Naval Service Guns :—

- (i) "P" tubes, so called because they were first used in guns having percussion locks.
- (ii) "S" tubes, used with guns which are fitted with "strikerless" locks.

The tubes of both types are "vent sealing."

The "seal" is obtained by making the tube a close fit in the vent (both vent and tube body being slightly tapered towards the front), and by designing the tube so that on firing the front portion expands and seals the escape of any gas between itself and the vent, and also by constructing the interior of the tube so as to prevent any gas escaping through the head.

The tube itself is prevented from coming to the rear by the lock or breech mechanism of the gun.

There are two patterns of "P" type tubes in use in the Service—electric and percussion; and there are two natures of each pattern, one for use in guns having large tube chambers, the other for use in guns having normal tube chambers.

There is, however, only one pattern of the "S" type tubes. "V.S. electric 'S' large," for use in guns 13·5-inch and above, which are fitted with strikerless electric locks.

When testing electric tubes with one Daniell cell, the electrical resistance should lie between 0·9 ohm and 1·1 ohm.

While "electric" tubes will not be fired or rendered dangerous by rough usage, they may, as a result of such treatment, become totally unserviceable, owing to the fragile wire "bridge" which they contain being damaged, with the result that the continuity of the electric circuit is broken, and the tubes cannot fire.

On the other hand "percussion" tubes are liable to fire or become dangerous as the result of a shock, and every precaution must be taken not only to ensure that the tubes are not subjected to rough handling during transit, &c., but also to prevent "jar" during loading, especially when closing the breech of the gun when the tube is already in the vent or in the adapter of a Q.F. cartridge.

In order to assist extraction, the heads of all V.S. (vent sealing) tubes are enlarged to a greater diameter than the body, and the underside of the head is bevelled to seat in the vent and on the extractor.

Tubes are stowed in a special locker.

Tubes for guns with large tube chambers.

These are commonly known as large tubes, and the following natures are now being manufactured and issued to the Service:—

Tube V.S. electric "S" large, Mark I.

Tube V.S. electric large, Mark IV.

Tube V.S. percussion large, Mark II.

These three natures of tubes are used in the following guns in the Naval Service:—

15-inch B.L. Mark I.

13·5-inch B.L. Mark V.

12-inch B.L. Marks XI and XII.

6-inch B.L. Mark XII and later.

5·5-inch B.L. Mark I.

4·7-inch B.L. Mark I.

4-inch B.L. Mark VII and later.

NOTE.—15-inch and 13·5-inch ("Iron Duke" Class and "Tiger") have strikerless electric locks, and therefore use the "S" electric tube Mark I. The remaining guns enumerated above use the large electric Mark IV tube.

Tube V.S. electric "S" large, Mark I. (Plate 6.)

This may be regarded as one of the most important tubes in the Naval Service, since it is used in the principal guns of the main Fleet when firing is being carried out in the primary manner, *e.g.*, by director.

It consists of a body, ebonite insulating cup, contact piece, copper plug, copper pole (tinned), wire bridge, insulated copper wire, vulcanized paper washer, cork plug, paper and glazeboard discs, and magazine filling.

The body is made by a series of cold hollow drawing operations, the magazine end being formed during this process, but the rear end being left solid.

The head is enlarged and bevelled to seat in the vent and on the extractor, and the body from immediately under the head is slightly tapered to the front to secure a good fit in the vent.

The body is bored out to take the copper plug (which carries the copper pole) and to form a passage for the insulated copper wire.

The bore for the copper plug is slightly tapered, as also is the plug itself, so as to form a seal against the rush of gas to the rear on firing. To improve this seal a gas check lip is formed on the front end of the copper plug, and a ball seating formed at the

TUBE, VENT SEALING, ELECTRIC, S, LARGE, MARK I.
GENERAL ARRANGEMENT.

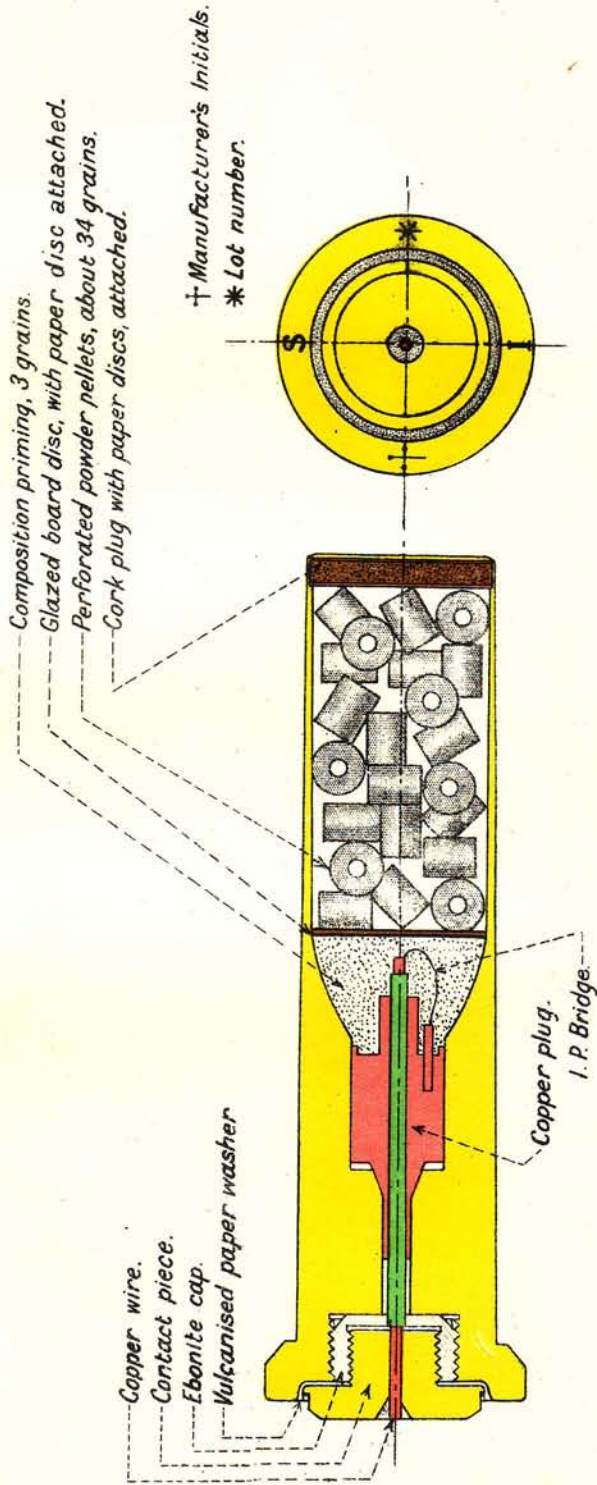

TUBE, VENT SEALING, ELECTRIC, LARGE, MK.IV. GENERAL ARRANGEMENT.

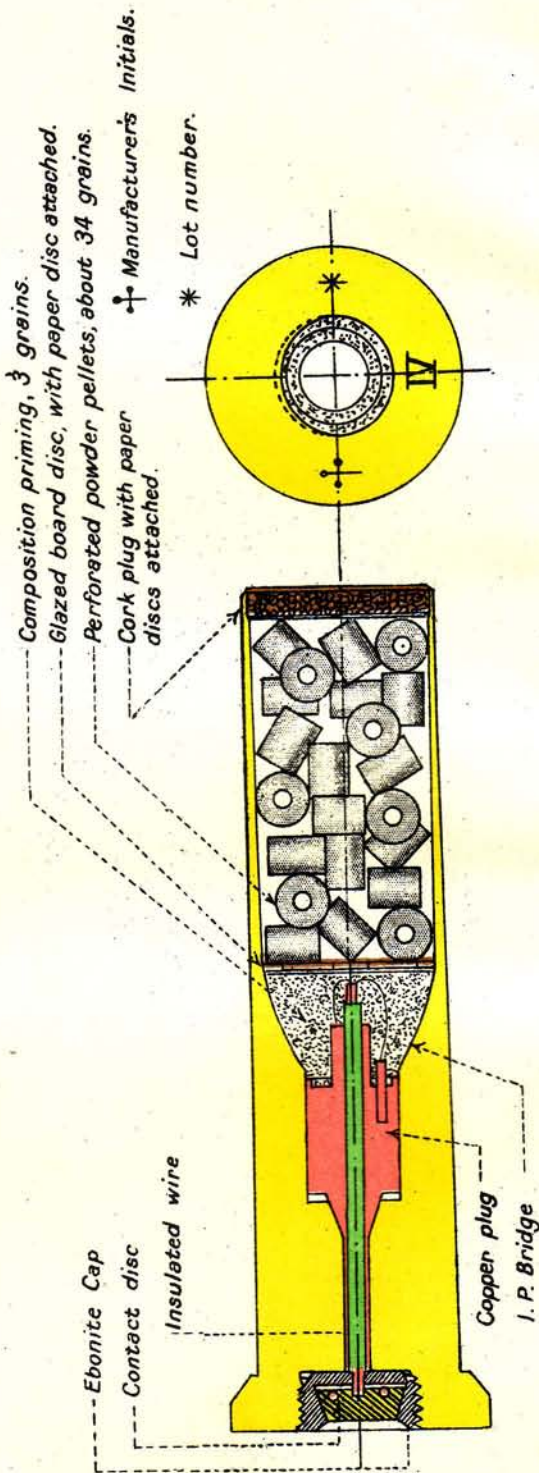

rear end to fit into the body. The interior of the head is bored out and screwed to take the ebonite cup, into which the contact disc is screwed after placing the vulcanized paper washer in position. The insulated copper wire passes through, and is gripped by, the copper plug. The rear end of the insulated wire is bared and passes through the contact disc, to which it is secured by solder.

The front end of the insulated wire is also bared, and a bridge of iridio platinum wire is formed from the bare end of the insulated wire to the copper pole, the bridge being secured at both ends by soldering.

The "bridge" is surrounded by a small quantity of priming composition, which is secured in place by means of a paper disc and a perforated glazeboard disc.

The magazine, which is lacquered internally, is filled with perforated pellets and the tube closed by means of a cork plug which has a paper disc shellaced to each side.

This plug is secured in place by burring over the metal of the body of the tube on to it.

To fire the tube an electric current is passed through the contact disc, down the insulated copper wire, across the I.P. (iridio platinum) bridge, and so to earth. This current fuzes the bridge, and ignites the priming composition, which in its turn ignites the magazine of the tube.

Tube V.S. electric "S" large, Mark I.C.

This tube is identical in construction with the "S" Mark I tube except that the overall length is slightly less. The letter "C" indicates that the tube is either a repaired Mark I tube or a converted and repaired Mark II tube. Tubes electric "S" large Mark II were fitted with Nobel vulcan bridges.

These bridges proved unsatisfactory, and all Mark II tubes have been withdrawn for repair and conversion to Mark I.C.

Tube V.S. electric, large, Mark IV. (Plate 7.)

This tube is used for electric firing in all guns which have large vents except 15-inch and 13.5-inch fitted with strikerless locks. It is identical in construction with tube V.S. electric "S" large, Mark I, except that it has a differently shaped ebonite cup, in which the bared end of the insulated wire is coiled down on to a copper washer, being secured in place by a plug of tin and antimony, this plug also forming the contact disc.

Tube V.S. electric, large, Mark IV C.

This tube is identical in construction to the large Mark IV tube except that the overall length is slightly less. The letter "C" indicates that the tube is either a repaired Mark IV tube or a repaired or converted Mark V tube.

Tube V.S. electric, large, Mark V was fitted with Nobel vulcan bridge, and, like "S" Mark II tubes, these have all been withdrawn for conversion and repair to Mark IV C.

Tube V.S. percussion, large, Mark II. (Plate 8.)

This tube is used in all guns which have large vents, when fitted with percussion locks.

It consists of a body, in which a solid anvil is formed towards the rear end, a percussion cap, cap holder, percussion holder, striker, copper shearing wire, brass washer, cork plug, paper discs, and a charge of perforated powder pellets.

The body is manufactured, as in the case of other tubes, by a series of cold hollow drawing operations, and an enlarged and bevelled head is formed.

The body from immediately under the head is slightly tapered to ensure a good fit in the vent. The rear end of the body is bored out and screwed for the reception of the cap holder and the percussion holder.

A cap seating and anvil are formed in the body of the tube and two holes are bored through the anvil, in order that the flash from the cap may ignite the powder in the magazine.

The copper cap, filled with cap composition, is placed in its seating and held there by the cap holder.

The bronze striker is secured to the percussion holder by means of a copper shearing wire, and the brass washer is placed on the end of the striker, the latter being rivetted over to hold it in position.

The percussion holder, complete with striker, is screwed into the tube.

The front end of the tube is closed by means of a cork plug and paper discs, the metal of the tube being burred over to hold it in position as before.

Powder dust from the magazine is prevented from escaping into the cap chamber by a paper disc being secured at the bottom of the magazine.

On firing the gun striker delivers a blow to the head of the tube striker which moves forward, shearing the copper shearing wire, so firing the cap.

Tubes for guns with normal tube chambers and for Q.F. guns, of which the cartridge cases are fitted with adapters and not for primers.

These tubes are commonly known as "small" tubes, and the following natures are now being manufactured and issued to the Service:—

Tube V.S. electric, "P," Mark VI.

Tube V.S. percussion, Mark VII.

Tube V.S. electric, "P," Mark VI.

This tube is identical in construction with tube V.S. electric, large, Mark IV, but it differs from that tube in being made smaller, so as to fit the normal tube chamber.

The magazine is filled with pistol powder in lieu of perforated powder pellets.

TUBE, VENT SEALING, PERCUSSION, LARGE, MK. II.
GENERAL ARRANGEMENT.

Surfaces to be blackened all over.

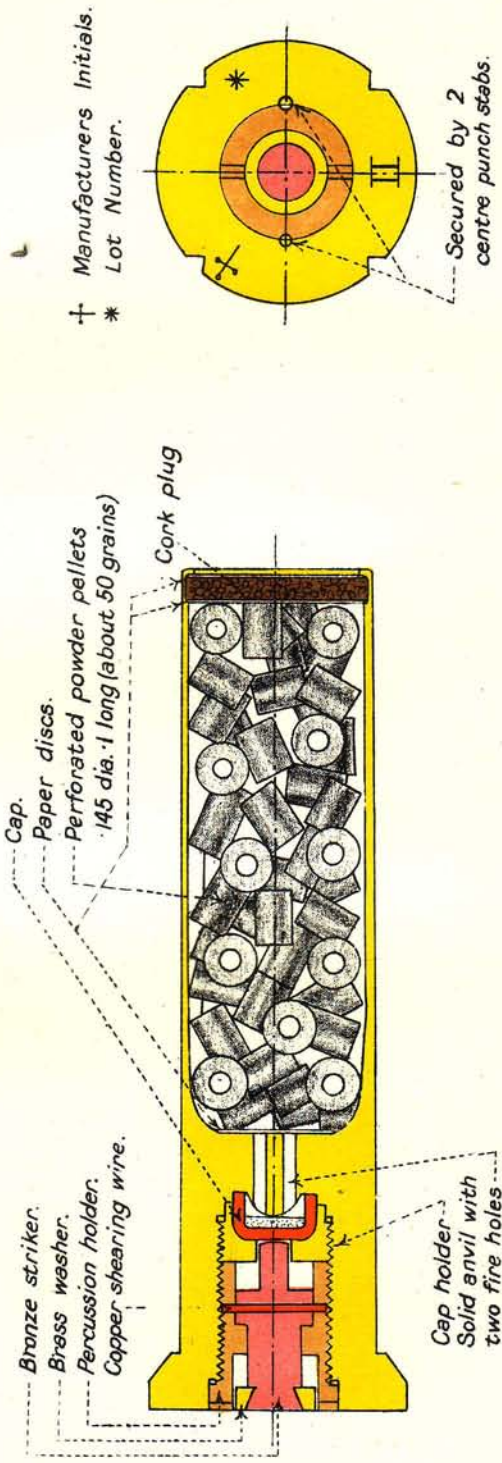

Tube V.S. electric, "P," Mark VI C.

This tube is identical with the Mark VI tube except that it is obtained either by repairing Mark VI tubes or by converting and repairing Mark VII tubes.

Tube V.S. electric, "P," Mark VII, was fitted with a Nobel vulcan bridge. This bridge having proved unsatisfactory, all Mark VII tubes have been withdrawn for repair and conversion to Mark VI C.

Tubes V.S. percussion, Mark VII.

This tube is identical with tube V.S., percussion, large, Mark II except that it is made to a smaller diameter in order to fit the normal vent.

The magazine is filled with pistol powder in lieu of perforated powder pellets.

While the tubes described above are at present the latest type in, and the standard types for, the Naval Service, tubes of earlier marks may still be met with, namely:—

Tubes, V.S., electric, large, Marks I-III.

Tubes, V.S., electric, "P," Marks IV and V.

Tubes, V.S., percussion, large, Mark I.

Tubes, V.S., percussion, Marks IV and VI.

Notes:—

(1) **Tubes, V.S., percussion, Mark VI**, were found liable to be fired prematurely by a sudden jar, and, consequently, manufacture was discontinued.

(2) **Improved methods of filling tubes.**—An improved method of filling the following tubes has been approved.

Apart from the filling, the tubes are identical with those described above.

Present mark of tube.	Mark when filled by improved method.
V.S. electric, large, Mark IV -	Mark VI.
V.S. electric S., large, Mark I	Mark III.
V.S. electric, P., Mark VI -	Mark VIII.
V.S. percussion, large, Mark II	Mark III.
V.S. percussion, Mark VII -	Mark IX.

Tubes for testing circuits, practice firing, &c.

The earlier marks of electric tubes will be found principally in Gunnery Schools, since they are being supplied for practice firing until stocks are exhausted.

Similar tubes will, however, also be found in the Fleet in small quantities as they are supplied to ships for testing circuits.

Friction tubes.—These are dealt with under Fireworks. Chapter XIII.

Drill tubes.—These tubes, which are similar externally to Service tubes, are supplied for exercising percussion firing.

The head of the tube is recessed, and this recess is filled with a hard rubber pad secured by a metal holder. The mouth of the tube is closed by a wood plug.

Drill tubes representing both Large and Small Service percussion tubes are supplied.

S.A.A. cartridge tube.—A percussion tube identical in shape with a .303-inch cartridge case is used with 7.5-inch and 11 inch Howitzers. The tube contains a charge of 30 grains of short milled powder, held in position by a glazed board disc, and the mouth is sealed by a cork disc covered with shellac and water-proofed.

Dummy tubes.—These are merely empty Service tubes with their mouths closed, so that their appearances are identical with the tubes they represent.

Dummy tubes are only supplied for instructional purposes.

Markings of tubes, identification and packing.

Markings.

The following markings will be found on the head of a tube :—

- (i) Letter (*i.e.*, “ P ” or “ S ”).
- (ii) Mark of the tube.
- (iii) Manufacturer’s initials or recognised trade mark.
- (iv) Lot number.
- (v) Acceptance mark (↑).

Identification of tubes.

The exterior of the bodies of electric tubes are not lacquered or coloured in any way, and are left plain and smooth.

Percussion tubes have the bodies blackened and lacquered, and four notches are cut out of the rim of the head, so as to enable percussion tubes to be differentiated from electric tubes by the sense of touch.

Drill tubes do not have the bodies coloured, but four longitudinal indents are impressed on the body, and the heads of the tubes are milled.

Dummy tubes have the word “ Dummy ” stamped on the head.

Strikerless or “ S ” tubes can be recognised by the protruding contact pieces.

Packing of tubes.

Tubes are packed 10 in a flat tin box, the box being sealed by soldered tape. Labels are affixed to the lids of the boxes to indicate their contents. The lettering on the labels is Red in the case of percussion tubes, and Black in the case of electric tubes.

“ Operation papers ” are enclosed in each box of tubes, and should always accompany a report of failure.

CARTRIDGE, Q.F., BLANK, 4 INCH, MARK V & V* GUNS, MARK II.

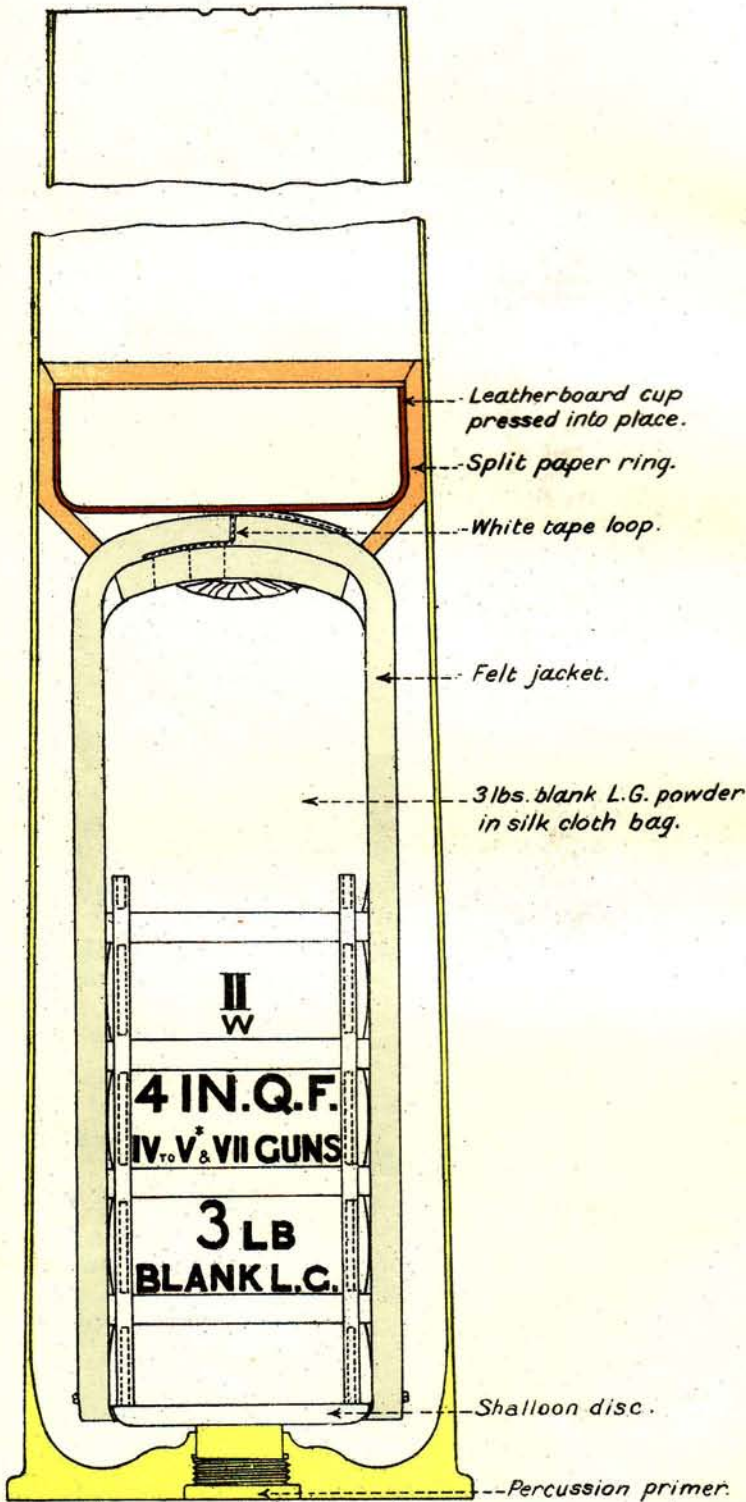

CHAPTER VII.

BLANK CHARGES.

Powder charges are issued for saluting purposes and as signals in special circumstances. These charges are used without projectiles and are termed blank cartridges.

Cordite is unsuitable for blank charges both because it is smokeless and because it will not give a sufficient report without a projectile to tamp the charge.

Saluting Ships.—All ships, except Destroyers, carrying four or more light Q.F. guns of the same calibre and commanded by a Captain or Commander come under the category of saluting ships.

Ships which do not carry light Q.F. guns as part of their fighting armament usually carry four 3-pdrs. for saluting purposes.

Supply of blank ammunition.—Blank cartridges are supplied to saluting ships for the nature of gun that is used for this purpose. In these ships the cartridges are supplied in the component parts and have to be made up on board.

Blank cartridges supplied to ships for guns other than saluting guns are already made up.

Blank cartridges for B.L. guns.

Blank cartridges for B.L. guns are only supplied when specially required. They are made up for 6-inch, 5·5-inch, 4·7-inch and 4-inch B.L. guns.

The body of the bag is made of silk cloth or cream serge. The bottom is shalloon.

After filling, the mouth of the bag is choked with doubled silk sewing. The cartridge is hooped by means of silk or shalloon braids passed through fairleads sewn to the bag.

Blank cartridges for Q.F. guns.

Cartridge, Q.F., blank, 4-inch, Mark V and V* guns. (Plate 9.)—The Service cartridge case is used to contain the charge, which consists of 3 lbs. of blank L.G. powder enclosed in a silk cloth bag. The rear end of the bag is closed with a shalloon disc and the front end is choked with silk sewing. Hoops of silk braid are threaded through three rows of fairleads sewn to the outside of the bag; these hoops prevent the escape of powder dust from the bag into the interior of the case. The bag is placed inside a felt jacket, which is open at the rear end, the space between the top of the bag and the jacket being filled with a felt disc. The cartridge is prevented from moving forward by a leather-board cup, which is pressed into place inside a split paper ring

and on to the top of the felt jacket. The ring and cup are secured by three dabs of shellac on the top edge.

The charge is ignited by a percussion primer which is secured in the base of the cartridge case in the usual manner.

Cartridge, Q.F. blank, 12-pdr., 12-cwt.—The Service cartridge case is used and contains the charge, which consists of $1\frac{1}{2}$ -lbs. of blank L.G. powder, enclosed in a silk cloth bag. The bag is hooped and choked similarly to the 4-inch Q.F. blank cartridge. The rear end of the bag is recessed to fit over a calico and paper dome, round the neck of which the bag is choked with a draw-string. A shalloon igniter, containing $8\frac{1}{2}$ -drs. of new blank F.G. or R.F.G.² powder is secured to the top of the dome. The latter fits over the adapter or primer, which is inserted in the base of the cartridge case in the usual manner.

A felt wad is placed on top of the silk cloth bag and the whole is retained in position by a leather-board cup, which is pressed down hard on the felt wad and secured by three dabs of shellac.

Similar blank cartridges, of varying weights, are supplied for 3-inch and 12-pdr. 4-cwt. Q.F. guns.

Cartridge, Q.F., blank, 12-pdr. 8-cwt. (Plate 10.)—The charge is the same as that for the 12-pdr. 12-cwt., but, owing to the short length of the cartridge case, a different method is adopted for retaining the cartridge in its case. The silk cloth bag is enclosed in a felt jacket, which is open at the rear end, the space between the top of the bag and the jacket being filled with a felt disc. The whole is retained in position by a tightly-fitting felt wad, which has a felt ring stitched to its under side. A silk braid loop, which passes through the wad, is attached to the felt disc inside the jacket, in order to facilitate removal of the cartridge.

Blank cartridges for the 12-pdr. 8-cwt. gun, when required, are supplied ready made up.

Method of filling 12-pdr. blank cartridges on board.

This operation is to be carried out in a place above the waterline under the supervision of the Gunner.

Procedure.

- (1) See cartridge case is perfectly clean and dry.
- (2) Insert a metal adapter, or electric or percussion primer. If percussion primer be fitted, a clip should be placed over the base of the case to protect the cap.
- (3) Stand the case vertically, so that it will remain steady on its base.
- (4) Insert the cartridge and felt wad.
- (5) Place the metal guide ring over the mouth of the cylinder.
- (6) Insert the leather-board cup in the guide ring and press hard home with the wooden drift.

CARTRIDGE, Q.F., BLANK 12 PR 8 CWT MARK II.

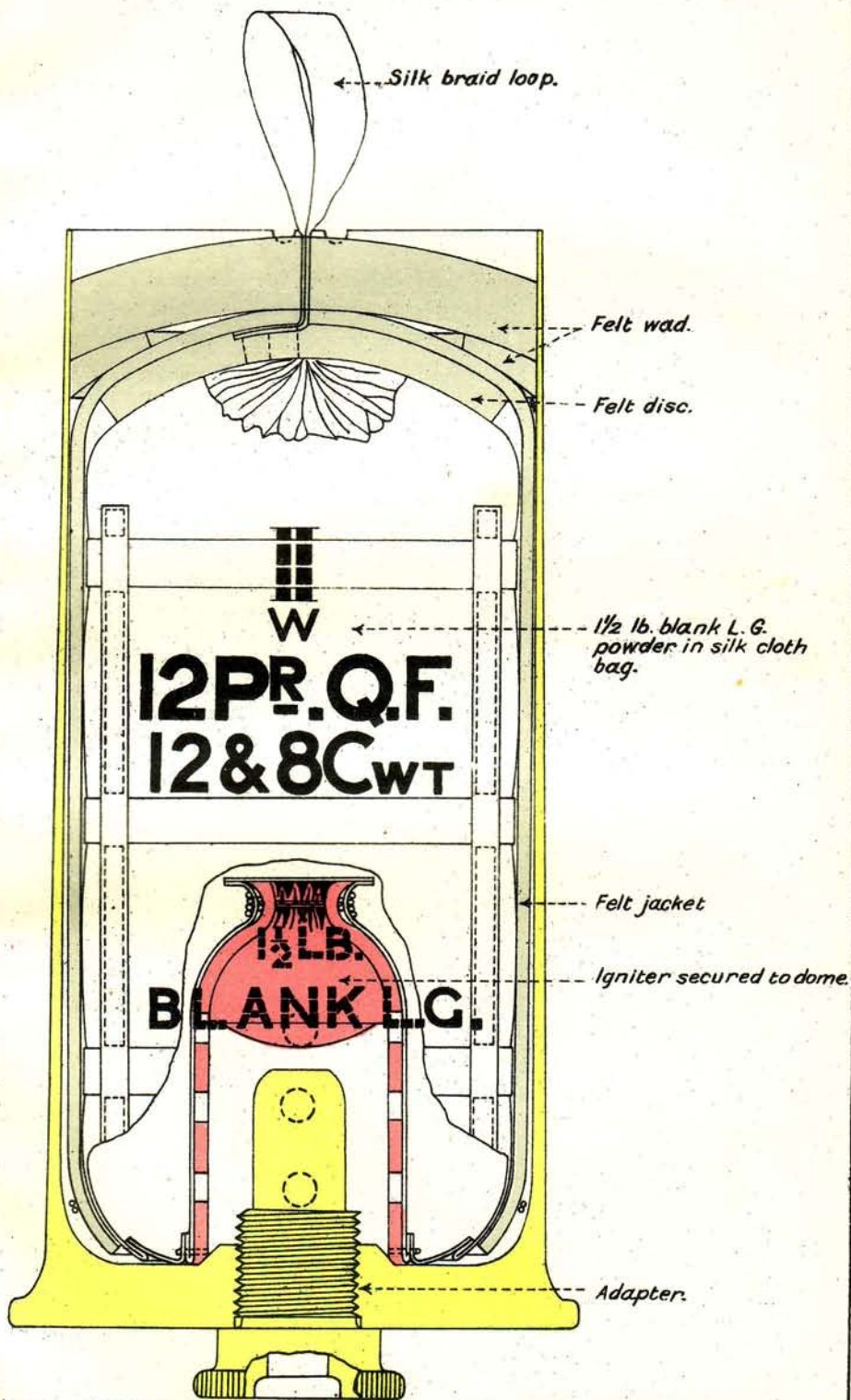

CARTRIDGE Q. F. BLANK
3 PDR MK IV.

CARTRIDGE Q. F. BLANK
6 PDR MK IV.

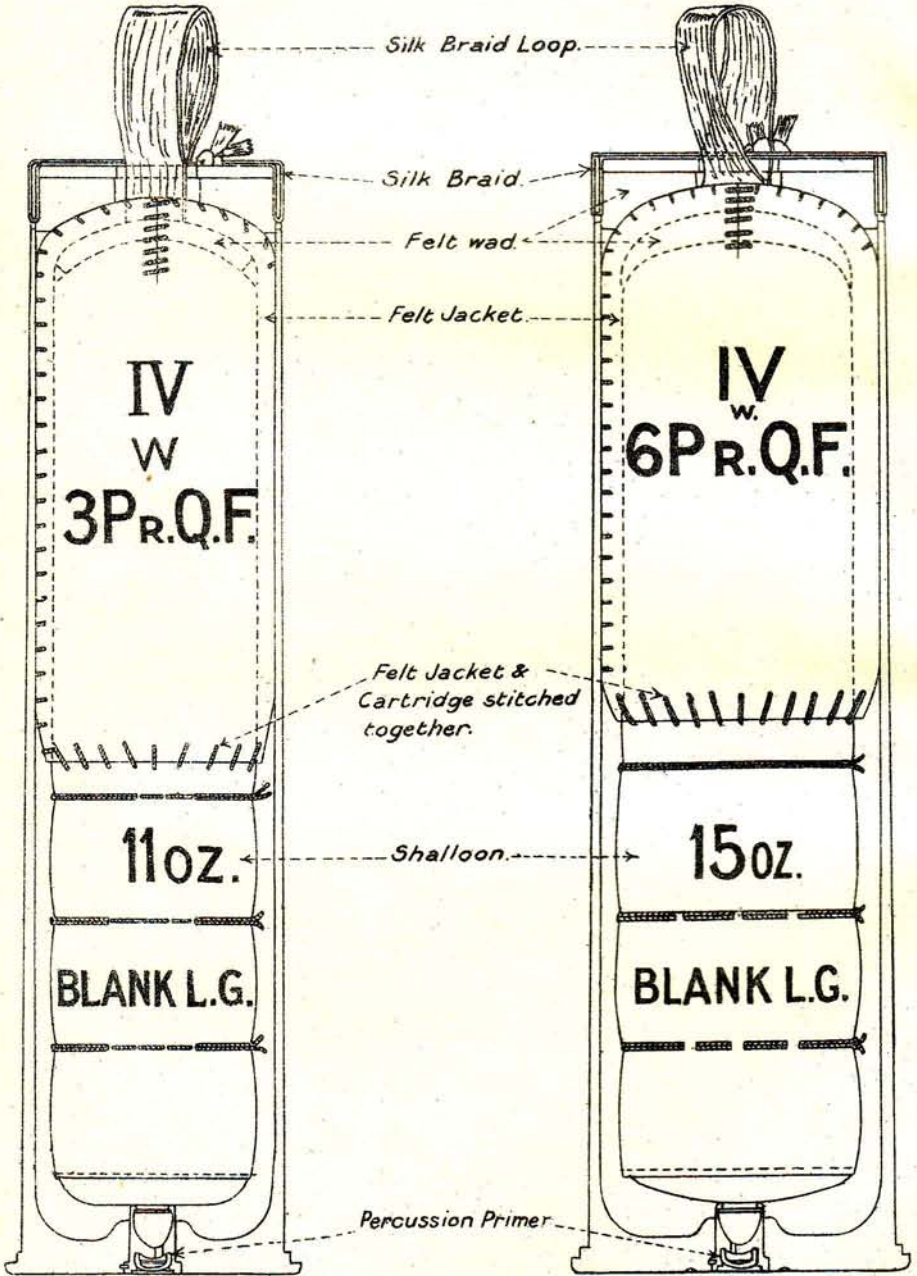

Cartridge, Q.F., blank, 6-pdr. and 3-pdr., filled, Mark IV. (Plate 11.)—The cartridge case is of solid drawn brass, varnished inside. Two slots are made in the case near the mouth. A hole is bored through the centre of the base. The hole is recessed and a spiral groove cut in the recess to take a removable primer.

The primer is of brass, with a cap chamber and anvil formed in its rear end, three fire holes communicate the flash from the copper percussion cap to about $5\frac{1}{2}$ grains of R.F.G.² powder, with which the body of the primer is filled. The front is closed with a glaze-board disc spun over and coated with shellac. A small brass pin projects from the head of the primer, by which it is secured to the case. There are also two slots in the head to take the screw-driver for inserting or removing it. The primers are issued in hermetically-sealed cylinders, 20 in each cylinder.

The charge for the 6-pdr. is 15-oz. blank L.G. powder, and that for the 3-pdr. is 11-oz. of the same powder. It is contained in a shalloon bag, hooped with silk sewing. The shalloon bag is sewn into a felt jacket, having a loop on the top. Over the charge is placed a felt and a millboard wad, the loop on the jacket being passed through holes in them; the whole is secured in the case by a piece of narrow silk braid, which is passed through the loop, then through the slots in the case, and finally tied on top, cutting off unnecessary ends.

3-pdr. and 6-pdr. Mark V blank cartridges have now been introduced, these differ from the corresponding Mark IV cartridges in that the bags are hooped in the silk or shalloon braids passing through fairleads on the cartridge bags. The felt jacket is secured to one of these hoops.

Silk braid, 0.35-inch wide, is supplied (with the cartridges) for securing the cartridges in the cases.

Thirty-seven 6-pdr. or fifty 3-pdr. charges for Hotchkiss guns are stored in a half metal-lined case, with the necessary wads and braid. Filled cartridges are also packed in half M.L. cases.

The empty cartridge cases are supplied 20 in a box painted red. On the outside of the lid is a lithograph, and instructions for making up.

The tools for repriming are issued in an ordinary wooden packing case.

In addition to the special screw-driver for inserting or removing the primers, a 12.7-inch rod is supplied for driving out the primer if set fast, or if the pin of it has been broken.

Method of filling 3-pdr. and 6-pdr. blank cartridges on board.

(1) The case being perfectly clean and dry, insert a new primer and place a clip over the base of the case to protect the cap.

(2) Stand the case vertically on a small board, suitably recessed for the clip, so that the case will stand steadily on its base.

(3) Insert the charge with felt and millboard discs attached in the case, the felt wad being placed next to the jacket; then

pass a piece of silk braid through the loop on the jacket and the slots in the case, and securely tie it across the mouth of the case. If there is any difficulty in inserting the cartridge, it should be slightly rolled on a bench or board by hand, to reduce the diameter, but it is necessary that the cartridge should fit tightly in the case.

Care is to be taken that the silk braid, after being passed through the slot in the cylinder, is made to lie flat, as otherwise a difficulty in entering the cartridge into the gun might be experienced.

Procedure to be followed with all blank cartridges for Q.F. guns which are filled on board.—The cartridge cases are only to be filled as required, but should a greater number have been filled than are found necessary for immediate use, those not fired are to be returned to their boxes for restorage in the magazine where necessary, safety clips having first been placed on the caps.

Cartridge cases, which have been filled on board, are to be emptied before being returned into store, the cartridge being restowed in the half metal-lined case.

For the stowage of a ready supply of blank ammunition for saluting purposes, steel lockers, capable of being locked, are fitted in most ships in a position conveniently situated to the saluting guns.

Precautions to be observed with B.L. blank cartridges.

On all occasions of withdrawing a blank cartridge from a B.L. gun it is to be passed overboard.

When firing blank charges from a B.L. gun, the cartridge is to be kept in a waterproof duck bag and not to be uncovered until the bore has been inspected.

Markings on blank cartridges. (Plate 12.)

B.L. blank cartridges have stencilled on one side :—

- (1) Mark of cartridge.
- (2) Contractor's initials or recognised trade mark.
- (3) Nature of gun.
- (4) Weight of charge.
- (5) Class of powder.

And, on the other side :—

- (6) N. Denoting Naval Service.
- (7) Initials of firm filling or monogram of filling station.
- (8) Date of filling (year and month).

3 Pdr Q.F.

Silk braid for securing charge in cylinder.

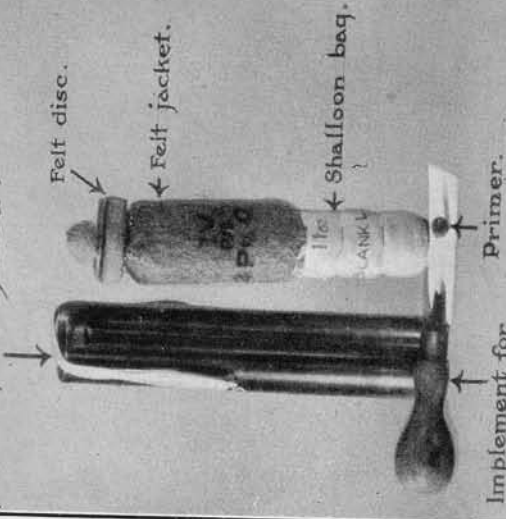

12 Pdr 12 Cwt.

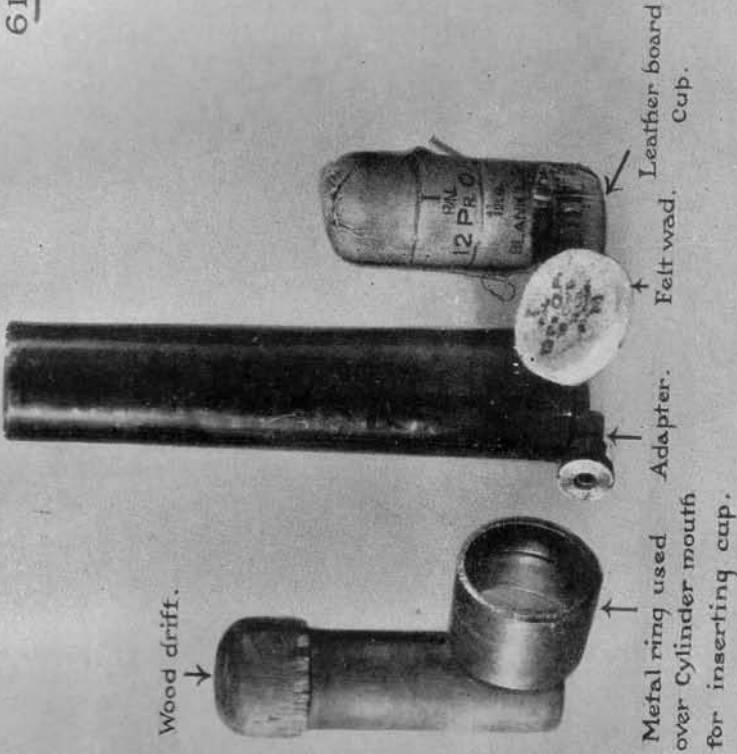

6 Inch B.L.



Q.F. blank cartridges have stencilled on one side of the bag :—

- (1) Mark of cartridge.
- (2) Contractor's initials or recognised trade mark.
- (3) Nature of gun.
- (4) Weight of charge.
- (5) Class of powder.

And on the other side :—

- (6) N. for Naval Service.
- (7) Initials of firm filling or monogram of filling station.
- (8) Date of filling (year and month).

The word "BLANK" to be stencilled across the base of Q.F. cartridges containing Blank L.G. powder.

Packing.—All cases containing blank cartridges or cases containing cartridge cylinders for making up blank charges (which may subsequently be used for temporary stowage of these charges), are painted red.

B.L. blank cartridges are supplied in M.L. cases.

Q.F. blank cartridges, when issued already made up, are supplied in Q.F. ammunition boxes.

12-pdr. 8-cwt. blank cartridges, not made up in cylinders, are issued in half metal-lined cases.

Other Q.F. blank cartridges not made up in cylinders are issued in bulk in "A" rectangular or M.L. cases, the cylinders in other ammunition boxes.

Wads, leather-board cups and filling pieces for making up these charges are supplied in wooden packing cases.

Cartridges for 3 and 6-pdr. blank are supplied in metal-lined cases, cylinders in special blank cylinder boxes.

CHAPTER VIII.

CASES, BOXES, &c.

General remarks.—For markings on boxes and cases, *see* sections at the end of chapters on B.L., Q.F., blank and S.A. ammunition.

All boxes and cases containing ammunition should be handled with care to prevent injury to their contents.

Rough usage of ammunition cases and their contents is calculated to cause miss-fires, hang-fires, or even premature explosions; and, further, ammunition boxes so handled cannot be expected to retain their airtightness or the contents their efficiency.

Further, jamming of the lids is the most common result of rough usage. This leads to loss of time in opening cases and a slackening of the rate of fire in action.

When ammunition of any kind is being handled, precautions should be taken to prevent damage to the cases in which it is packed. These precautions are to apply to ammunition handled either in lighters or on shore, as well as on board ship. Care should be taken not to lower ammunition boxes too quickly, and ample time is to be allowed for the receipt or discharge of ammunition; moreover, such receipt or discharge should never be treated as an evolution or as a matter of competition between ships. Cylindrical cases should never be rolled along the deck.

Should cases occur in which combustibles of any kind appear to have been handled roughly, full enquiry is to be made with a view to the persons in fault being made responsible.

Ammunition for Naval Service is supplied from depôts to the ships in cases of various types. These ammunition cases themselves are stowed in the magazine and their contents are not removed until required; except 6-inch and below in submarines. The cases are so arranged that the charges can be withdrawn while they are stacked in their stowage.

All cases for stowing in magazines are made of wood or brass. Boxes of iron are sometimes used for the transport of explosives such as detonators.

Luting.—Cases are made airtight either by luting, jute yarn and luting, or dermatine rings.

Luting (Mark III) consists of 80 parts by weight of whiting, 20 parts of mineral jelly, and one part of castor oil. It is issued ready for use in tin cylinders containing 1-lb.

Luting is a thick paste which does not easily dry, and when placed between metal surfaces it forms an airtight joint.

Luting used for making powder or ammunition cases water-tight should be examined as far as possible every six months.

Face page 54.

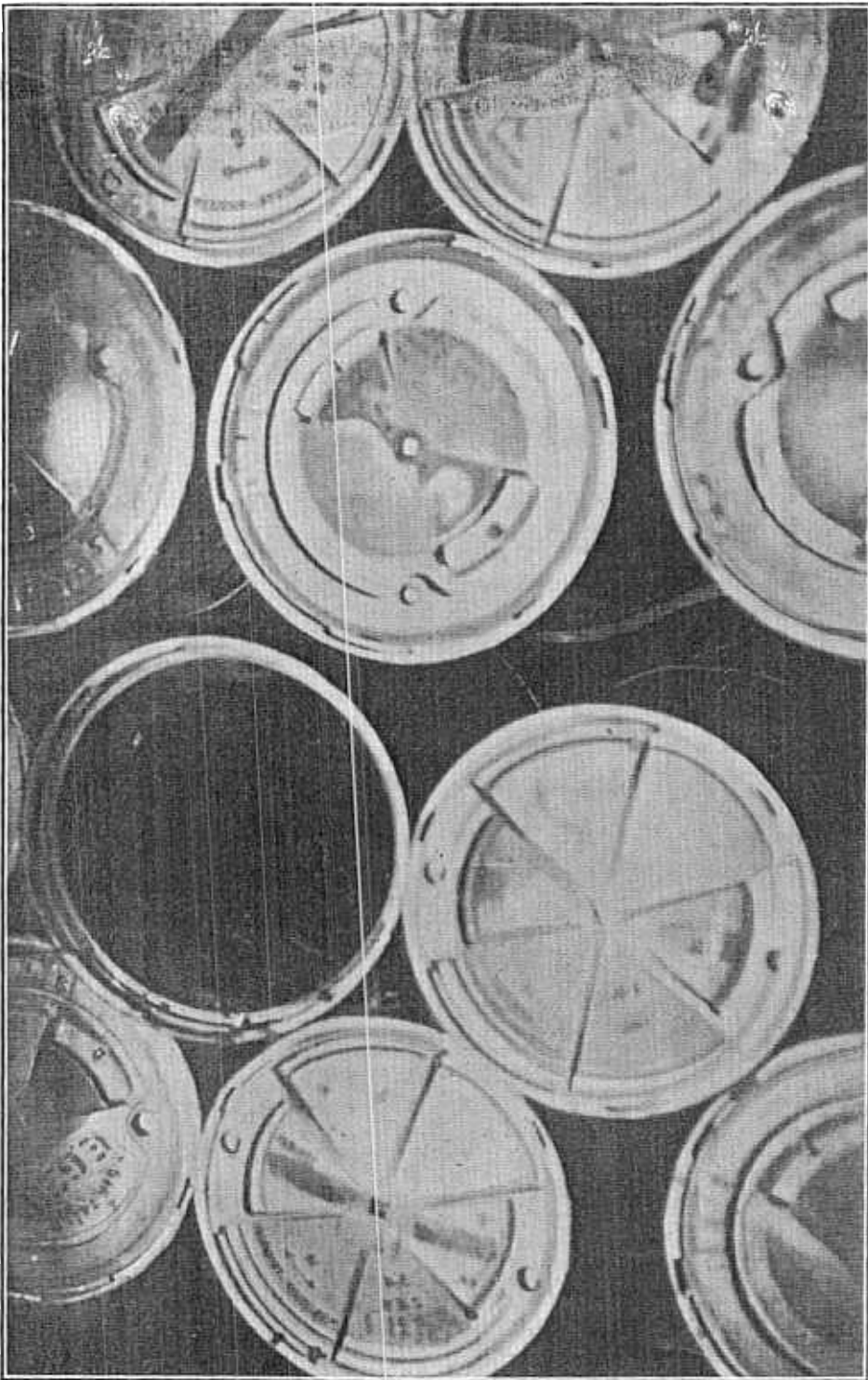

EFFECT OF CORDITE EXPLOSION IN A BAY OF WEAKENED CASES.
22194

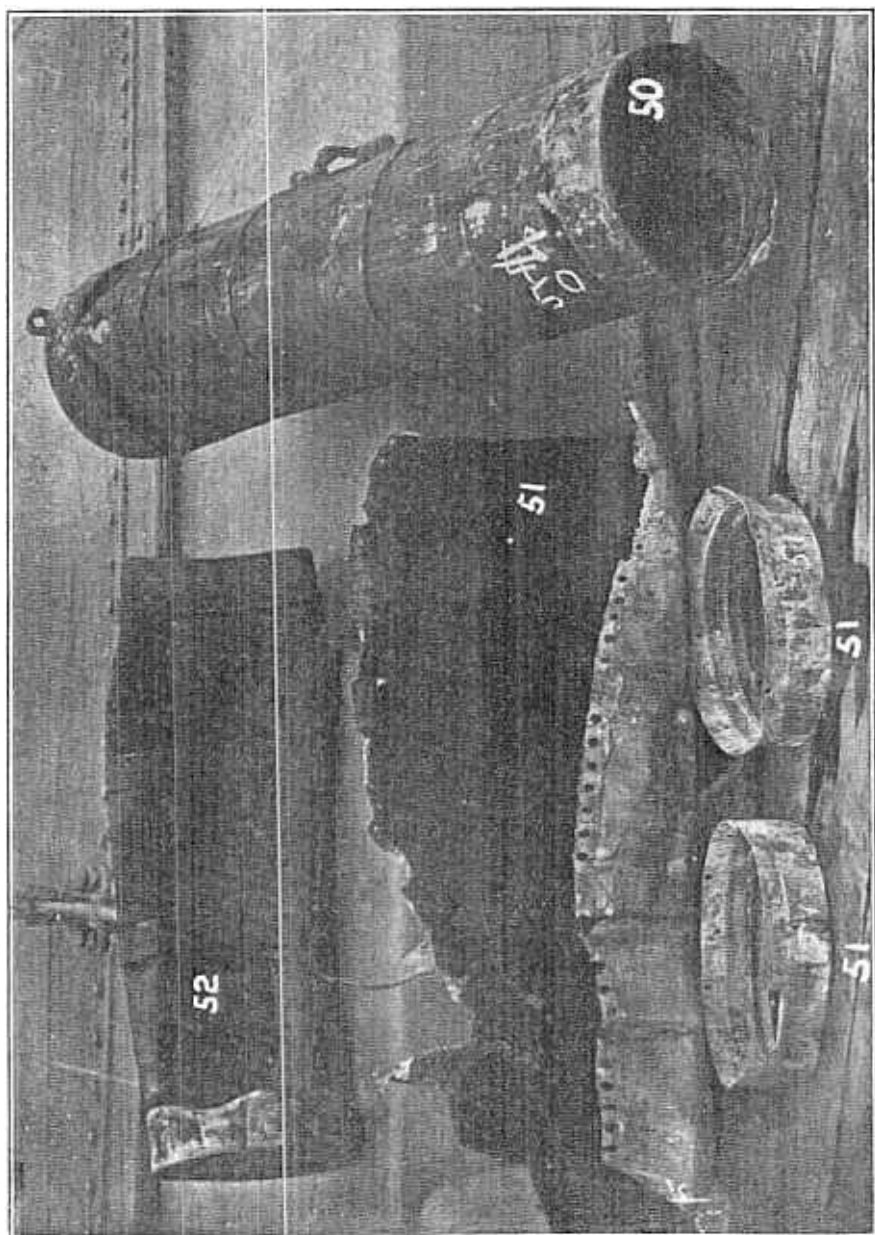

UNWEAKENED CASES.

EFFECT OF CORDITE EXPLOS

to see that it is not dry, and whether it is still efficient. The lids of cases are not, however, to be removed especially for this purpose.

Dermatine.—Dermatine is a rubber composition. A ring of dermatine is pressed into a groove round the lid or opening of the case so as to form an airtight seating for a flange.

All metal cases are tested for airtightness either by being immersed in warm water or by air testing pump, both on receipt into store and after packing. For this purpose a hole, threaded and plugged, is to be found in the lid.

Designation.—All rectangular and cylindrical cases are designated by letters which denote the shape and dimensions. Variations of manufacture and fittings of cases of the same dimensions are given different marks.

Weakening of cases.—If a cordite charge becomes ignited inside a closed case (from spontaneous decomposition or other causes), if the case is sufficiently strong, the internal gas pressure will be resisted and violent explosion will occur, which may endanger the contents of neighbouring cases. The cases are therefore arranged to present as little resistance as possible to internal pressures, so that, should decomposition occur, the case may open out and release the gases given off before a violent explosion occurs.

Further, it has been experimentally established that if a charge is fired in a case, by spontaneous ignition or other causes, provided the case is sufficiently weak, the damage to the neighbouring cases will not be serious and the explosion of the other charges in them will be avoided. In this connection, however, it is pointed out that, if the lids of neighbouring cases are not in place for any reason, their contents will be fired and the advantage obtained by the weakening of the cases will be lost.

Experiments have shown that if an unweakened case is exploded in a magazine, the damage to it and the surrounding cases is such that the explosion of the entire magazine must certainly follow. (Plates 13 and 14.)

As the cases have to be used for transport purposes as well as for stowage, the cases must also be made to withstand rough treatment. All cylindrical cases, and certain earlier types of rectangular cases are therefore arranged so that they can be strengthened during transport and weakened for stowage. Such cases have some simple device, which was set to the stowage position when the case was in the magazine, and to the strengthened position while the case was in transport.

It was decided in the early months of 1923 to abandon the venting principle in designs of cordite cases required for new construction; by so doing it is hoped to be able to produce strong flash and watertight cases, and designs are now being made on these lines of cases required for new Capital Ships.

Modifications to existing cylindrical cases are under consideration, but it is thought probable that no alterations to rectangular

cases will be necessary, as experience has shown the latter to be strong and able to retain their flash and watertight qualities after normal treatment in the service.

Experiments on a small scale will be carried out in an endeavour to obtain designs of cases which, whilst maintaining their flash and watertight qualities under Service conditions, will also vent if a charge becomes ignited under storage conditions.

Cases are now stowed in the transport position.

Rectangular Cases.

Rectangular cases are made of sheet brass, corrugated to give strength. The ends are solid and secured to the sides by various means.

The size of the case and lids vary according to stowage requirements.

Earlier rectangular cases have their top ends secured to a flange, rivetted and sweated to the sides of the case, by an arrangement of nuts and bolts. These nuts and bolts can be screwed hard down for transport purposes and eased back for weakening so that the flange and lid were only held by a small quantity of solder. Special tools are supplied for this operation.

These systems are being abandoned in favour of that described for use with later cases, and the old types are being converted to the new design.

New rectangular cases are being made with the sides fitted inside the flange of the bottom and outside the flange of the top end. Consequently, if a charge goes off, the internal pressure will open up the sides at the top in preference to the bottom of the case. The sides are lightly rivetted to the top. (Plate 15.)

While this arrangement gives little resistance to the internal pressure, the cases are strong enough for transport and no special devices are necessary to prepare the cases for transport or stowage.

(Plate 16) shows the "W" rectangular corrugated case which is typical of practically all cases of other sizes.

The "R" Mark II has a lid having two handles for removing and a cross-bar with a screw bolt in the centre for tightening the lid. The groove in the case is packed with jute yarn and luting. The rim of the lid is pressed down into this and held firmly by the bolt in the cross-bar, thus making the case airtight.

To open the case, the screw bolt in the centre of the bar is eased back with a "rectangular" key; the cross-bar working on a pivot at one end can then be revolved clear and the lid lifted straight off.

Lids of later cases are secured differently, being made in two parts, the lid proper, and the locking ring, which is a device to secure the lid in the same manner as the cross-bar in the Mark II case. This locking ring has three projections which take in similar wedge-shaped featherways around the opening of the case, and two holes are cut in the upper surface of the locking ring for the purpose of shipping a spanner. In revolving this

RECTANGULAR CASE.

SHOWING METHOD OF ATTACHMENT OF TOP AND BOTTOM.

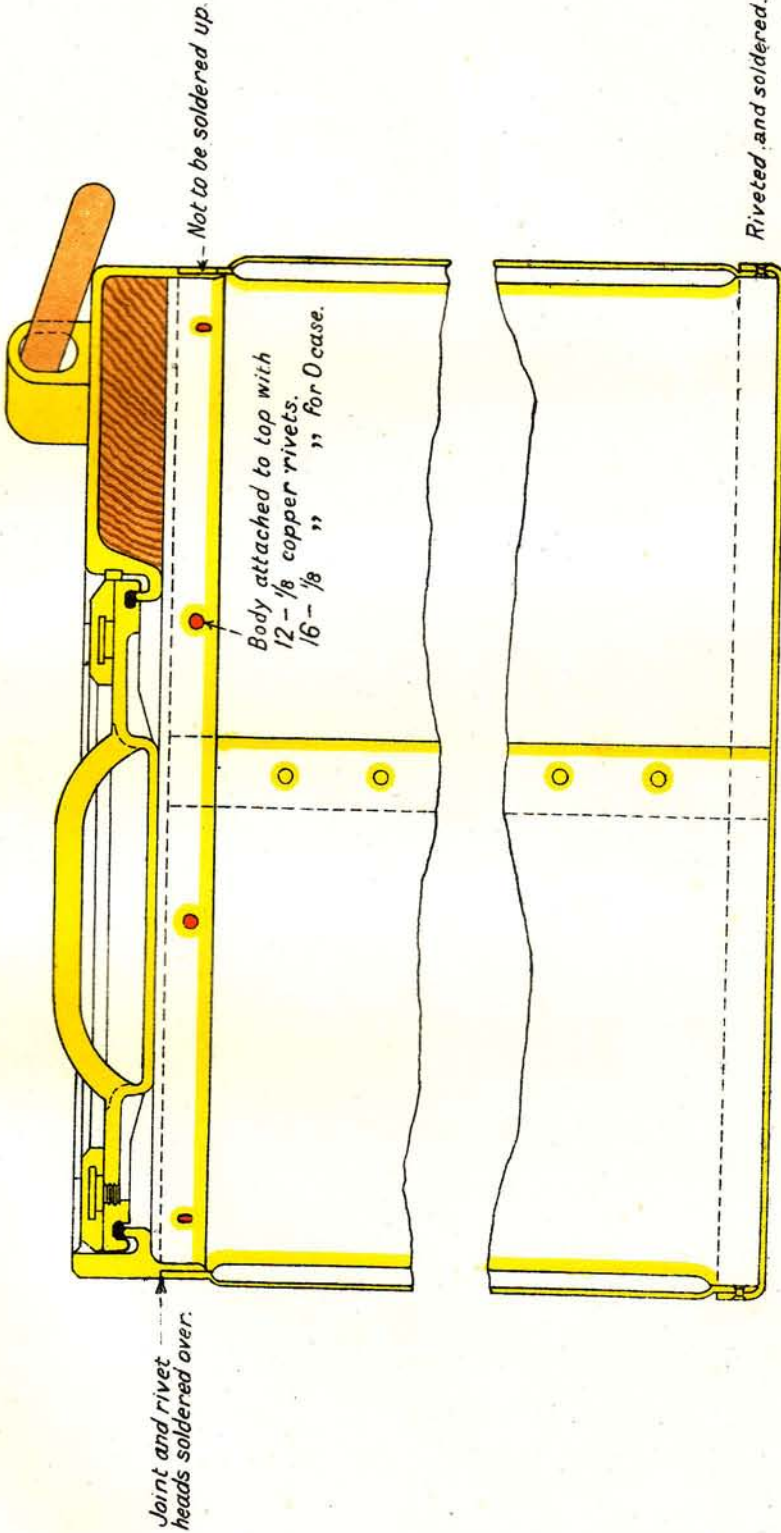

RECTANGULAR CASE "W".
— TYPICAL. —

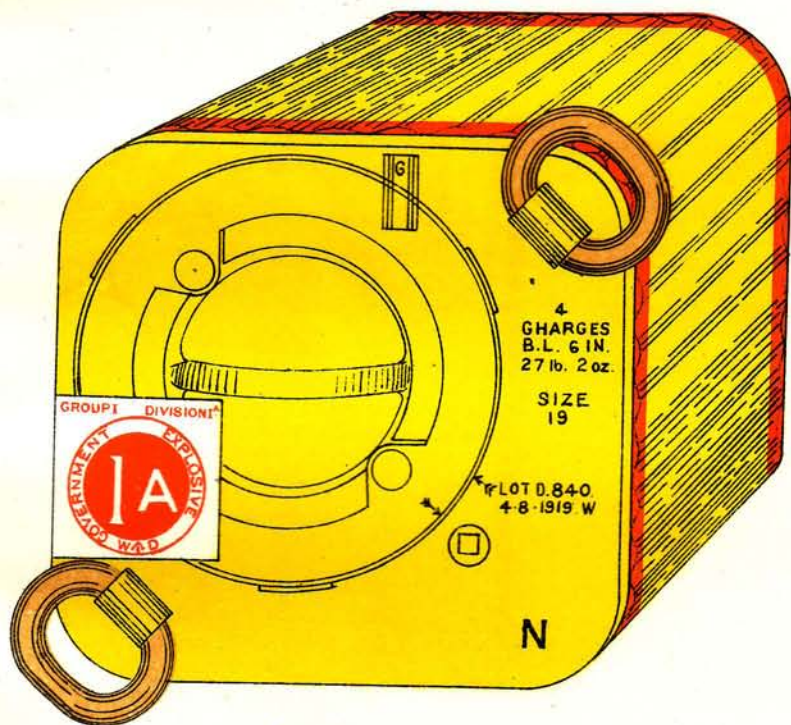

Face page 57.

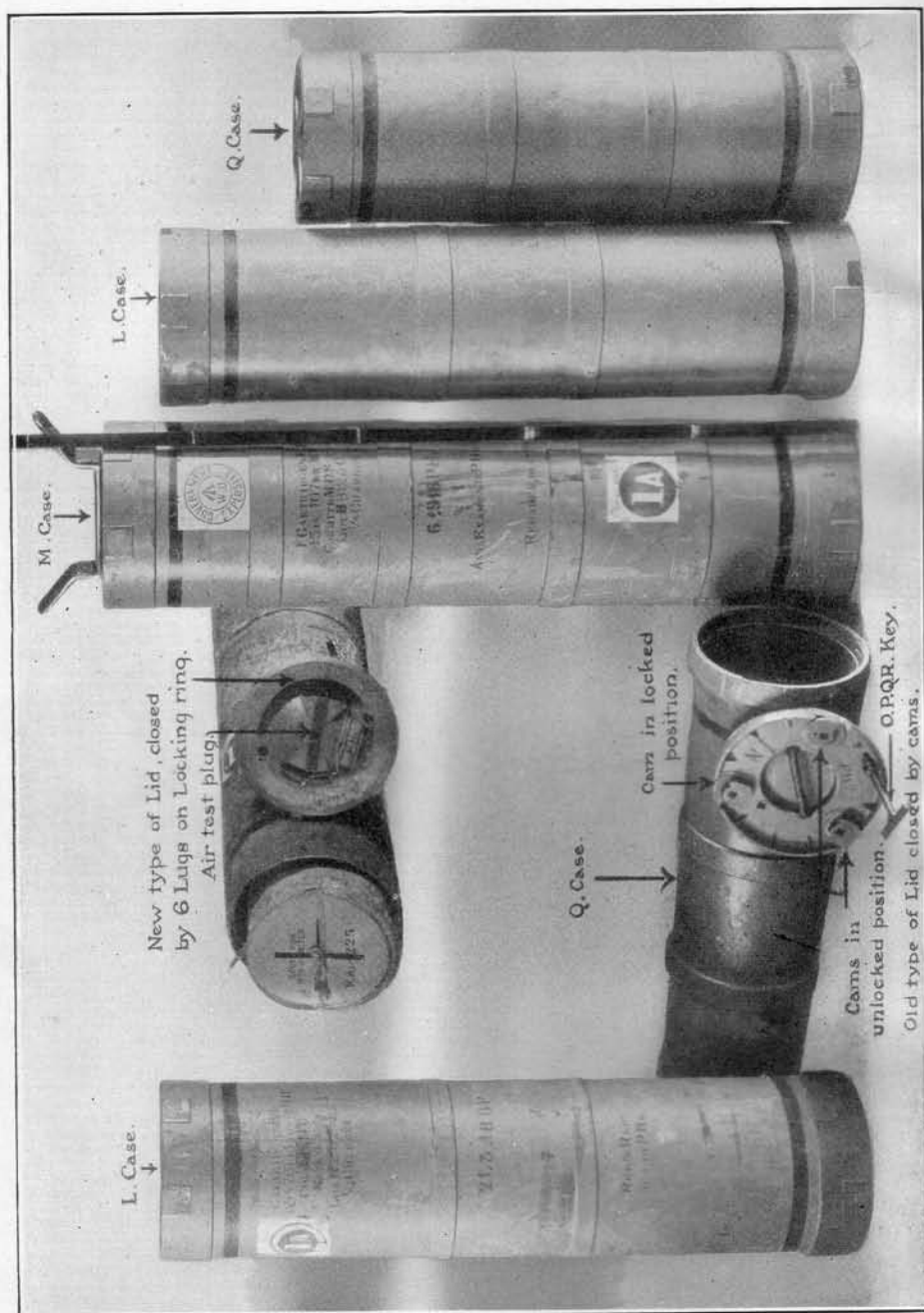

GROUP OF CYLINDRICAL CASES.

locking ring, the lid does not revolve with it, so that the seating of the dermatine ring is not disturbed.

The "T" case is similar to the "W" case.

All these cases have handles of copper wire covered with leather for slinging.

To prevent the irregular fittings of ends of cases causing injury to cartridges, they are packed with wood linings.

Wooden packing pieces in the shape of stools, &c., are often used in cases, for convenience of packing.

These rectangular cases are not intended to be moved when in action.

When emptied, or partially emptied, the cases should be clearly marked with a piece of chalk to show what remains in them.

Most of the cases built on the principle of the "R" Mark II have been declared obsolete for future manufacture, but will, of course, remain in the Service for many years. The differences between those and the newer cases are only in the design of the lid and weakening arrangement.

Cylindrical Cases. (Plate 17.)

Cylindrical cases are used for all B.L. cartridges for 12-inch guns and above.

Cylindrical cases are fitted with a lid at each end. They are made of sheet brass, rolled and jointed with rivets. Four strengthening bands encircle the case, and handles made of copper wire covered with leather are fitted. The lid of the case is secured by feathers or lugs taking under recesses on the rim of the case and made airtight by a dermatine ring.

These recesses are of two natures, the one being solid with the case and the other being formed by lightly rivetting a metal strip on to the case. When transporting the case, the lid is revolved to the right so that the lugs engage under the solid or strengthened portion; for the weakened position the lid is revolved to the left so that the lugs are merely held beneath the lightly attached metal strip. Cases are stowed in the transport position.

Most cases have three such lugs, though certain larger ones have six. In these latter, though all six lugs are in action when the lid is locked in the transport position, only three lugs are covered by the weakened strips for stowage, the remainder being clear and inoperative.

All cylindrical cases have a red band across the lid and a red mark on the side of the case. These are in line when the case is locked for transport.

"M" Mark II cases have a set screw in each end ring which can be screwed home to prevent the lids falling off during transport or in stowage. These screws must be slacked back to enable the lids to be turned from the "Transport" to the "Weakened" position and *vice versa*, and the screw at the accessible end of the case, *i.e.*, the screw controlling the lid which will be removed

when the contents of the case are required, must be left slacked back when the case is stowed in the magazine. The screw at the inaccessible end of the case should be screwed home after the lid has been moved to the weakened position, so as to prevent the lid falling off under vibration.

Similar screws are being fitted to "M" Mark I and "L" cases. Other types of lid locks are under trial.

Cylindrical cases have two small holes in the case and one in the lid so that the label can be secured by tapes in such a manner as to prevent opening the case without breaking the tapes.

Clarkson's cases.

These are supplied to all hand-worked B.L. guns for conveying cartridges from the magazine to the gun. They are cylindrical cases opening at one end, built up of cork, and covered inside and out with canvas.

Boxes for Q.F. Ammunition. (Plate 18.)

Q.F. ammunition is stowed in boxes of varying space and size. The general design is common to all.

Boxes for Q.F. Ammunition Separate Loading.

The boxes are made of teak and lined with zinc or tinned copper. The lid is fastened by a locking plate engaging four metal bolts, the plate being moved by an eccentric actuated by a rectangular key.

The box is strengthened by battens on the top and sides and by brass straps round the ends.

To force the lid up, should it be stuck by the luting or paint, a notch is provided under two corners of the lid, so that the handle of the key can be inserted and the key used as a lever.

The handles are of copper wire rope with a leather grip.

The box is made airtight by luting placed in a recess round the lid.

The lid is held by a frame, the corners of which form bolts which take under slots cut in four studs secured to the top edge of the case. This frame is built into the lid and is moved by a central cam which is revolved by the ordinary rectangular key (metal key Mark IV).

Various information about Q.F. ammunition boxes is given in the following table:—

Gun.	Cartridges in Box.	Stowage.
4·7-inch, Marks V and V*	4	Horizontally.
4-inch, Marks IV and V -	6	Vertically.
4-inch, Mark III - - -	8	Vertically.
3-inch 20-cwt. Q.F. - - -	4	Horizontally.
12-pdr. 12-cwt. - - -	10	Horizontally.
12-pdr., 8-cwt. - - -	10	Vertically.
12-pdr., 4-cwt. - - -	8	Vertically.

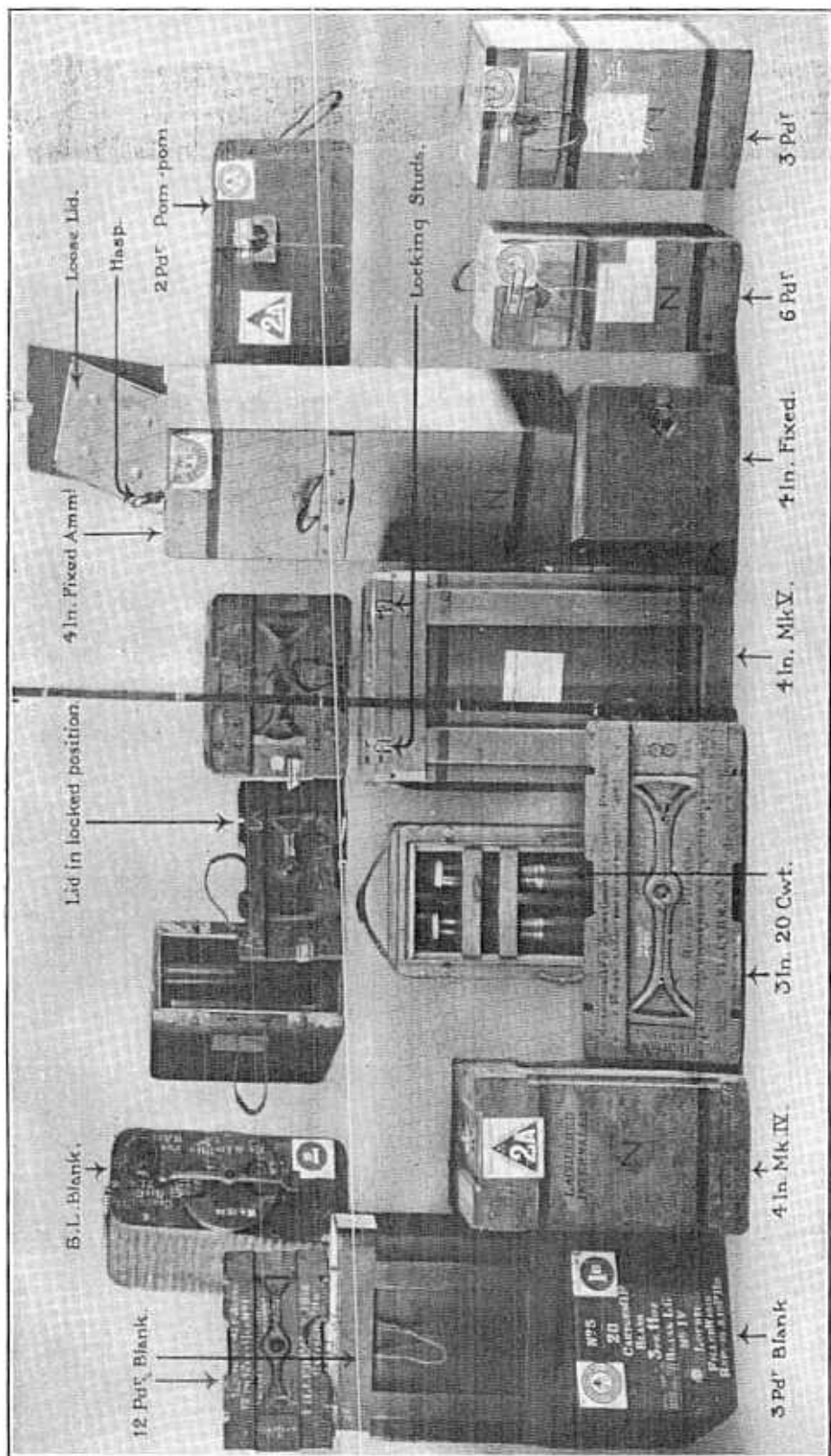

GROUP OF Q.F. AMMUNITION BOXES.

Wood and metal packing pieces are fitted to hold the cartridges steady in their cases. Canvas bands or bechets are fitted to extract 4-inch and 12-pdr. cartridges stowed horizontally—these latter being stowed “heads and tails.”

Boxes for 6-pdr. and 3-pdr. ammunition.

These boxes are made of teak. The lid works on hinges, and is secured by a hasp and a turn buckle which is secured by white line.

These boxes are passed up to the gun when in action. The loose lining of tinned copper fits inside the box, having a groove round its top edge to receive luting in order to make an airtight joint; a lid of tinned copper having a flange to rest in the groove closes the inner lining. There is a false top and bottom of tinned copper with holes to take the cartridges base up, and a wooden bottom with recesses to take the points of the shell.

The 6-pdr. box holds 11 cartridges and the 3-pdr. box holds 16 cartridges.

The Mark I boxes were not lined, and are used for dummy cartridges. They are painted black.

Special boxes painted red are supplied to hold 20 cartridge cases, empty, for making up blank.

Boxes for 4-inch Q.F. ammunition, Marks IV, V, VII and XII guns.

These boxes are very similar to the above, except that they are much longer. They hold four cartridges each.

Metal-lined cases.

These cases are used for small combustible stores, and for boat-work, as, after being opened, they can be made watertight again.

They are made of wood, lined with tinned copper.

The lining is closed by a circular bung made watertight by luting, and the case has a square hinged wooden lid over the bung. The lid is secured by two screw bolts, which can be withdrawn by a special key with two prongs to it.

There are three sizes of metal-lined cases:—

- (1) The whole metal-lined case.
- (2) The half metal-lined case.
- (3) The quarter metal-lined case.

Whole metal-lined case may contain any one of the following:—

7,680 rounds of .303-inch blank ammunition.

70 sound signal rockets.

10 rounds of 4.7-inch blank ammunition.

Half metal-lined case may contain any one of the following:—

3,400 rounds of .303-inch blank ammunition.

50 11-oz. saluting charges for the 3-pdr. Q.F. Hotchkiss Mark I.

- 43 saluting charges for the 3-pdr. Vickers Mark I.
- 37 15-oz. saluting charges for the 6-pdr. Q.F.
- 20 1-lb. 8-oz. blank charges for the 12-pdr. 8-cwt.
- 30 1-lb. 8-oz. saluting charges for the 12-pdr. 12 and 18-cwt.
- 20 6-pdr. blank charges made up for Destroyers.
- 25 3-pdr. blank charges made up for Torpedo Boats.
- 35 sound signal rockets.
- 30 blank charges for the 3-inch H.A.
- 18 charges for the 3·5-inch bomb thrower.
- 5 filled maxim belts.
- 300 Very's light cartridges.
- 144 1½-inch V.B.S. cartridges.

Any one of the following kinds of ammunition or combustible stores may be stowed in a **quarter metal-lined case** :—

- 1,200 rounds of ·303-inch ball ammunition for boat service.
- 840 rounds of ·303-inch ball ammunition in chargers.
- 1,450 rounds of ·303-inch blank ammunition.
- 9,100 rounds of Morris tube ammunition.
- 10,000 rounds of rim fire cartridges No. 2.
- 120 cartridges for Very's lights.
- 60 powder charges for torpedo impulse.
- 50 tonite charges.
- 48 1½-inch V.B.S. cartridges.
- 100 cartridges for safety fuze.

Sealing of cordite cases and ammunition boxes. *See also* p. 23.—

A method of sealing cordite cases is being introduced, consisting of a tape sealed over its two ends with a special seal kept at a Naval Armament Depôt. This arrangement prevents the lid of a case being removed without breaking the tape, and the tape cannot be replaced and resealed without possession of the proper seal.

(2) The lid can be turned from "transport" to "stowage" positions and *vice versa* without cutting the tape, so that the usual procedure carried out on board will not be affected by its presence. Cases are now stowed in the transport position.

(3) Air testing plug holes in cordite cases are sealed with the same seal as that used with the sealing device for the lid.

(4) Methods of sealing the locking arrangements of ammunition boxes are also being introduced. These vary in detail to suit the different types of boxes.

(5) The sealing devices of cases and boxes so fitted are to be examined on receipt on board, and any cases or boxes with broken seals or tapes are to be returned to the Naval Armament Depôt accompanied by a report of the circumstances.

(6) When not returning cases of cordite or boxes of ammunition to a Naval Armament Depôt, any with broken seals are to be kept separate and the Naval Armament Depôt is to be informed.

Small arm ammunition boxes.

There are two kinds of small arm ammunition boxes for use in the Naval Service :—

- (1) Large S.A.A. box (Mark XI) (which is technically known as "Box, G.S., S.A.").
- (2) Half S.A.A. box (Mark I) (which is technically known as "Box, half, naval").

The large S.A.A. box is made of wood with a tin lining. It has a sliding lid, attached by whipcord to the box to prevent its being lost when the box is open. When shut, the lid is secured by a split pin which has a short length of twisted copper wire by which to withdraw it. This wire lies in a groove which is covered with a calico seal label; a loop of leather for the finger is attached to the wire behind the seal, and the end of the wire is secured to the lid of the box. Thus to open the box the seal label must be broken.

The tin lining has a tin lid soldered to it, fitted with a wire handle, by means of which it is torn off when the box is to be opened, a sharp pull being given. Once opened, the box cannot be made watertight again except by soldering down this lid. Copper wire handles, part of which are covered with leather, are fitted at each end for transport.

The half S.A.A. box is of similar construction to the above, except that it is only of half the size and has a copper wire handle at one end only. The lid is secured by a brass split pin having a T-shaped handle attached to it.

To open the boxes.—Take out the split pin, slide back the lid, and then tear off the cover of the tin lining according to the printed directions found there.

The tin lining of small arm ammunition boxes is liable to deteriorate; in consequence—

- (A) The oldest ammunition in the ship should be used for target practice as far as possible.
- (B) The tin lining of all boxes which are passed up for target practice should be lifted out and examined by unscrewing the wooden top. If the lining of any box is found defective, others of the same date are to be examined, and, if necessary, the ammunition to be exchanged at the first opportunity.

Any one of the following quantities of ammunition may be stowed in a large, small arm ammunition, box :—

- 960 rounds of .303-inch cartridges for machine guns.
- 1,100 rounds of .303-inch ball ammunition.
- 1,000 rounds of .303-inch ball ammunition in chargers.
- 840 rounds of .303-inch ball ammunition in bandoliers.

- 850 rounds of .303-inch ball Mark VII ammunition in chargers.
- 1,100 rounds of .303-inch blank ammunition.
- 680 rounds of .45 ball aiming ammunition G.G. chambered.
- 96 rounds of 1-inch aiming electric and percussion ammunition.

Any one of the following quantities of ammunition may be stowed in a half, small arm ammunition, box :—

- 828 rounds of Webley pistol ammunition.
- 500 rounds of .303-inch ball ammunition.
- 350 rounds of .303-inch ball Mark VII ammunition in chargers.
- 600 rounds of .303-inch blank ammunition.
- 480 rounds of .303-inch ball Mark VII ammunition in cardboard packets for Lewis guns.

CHAPTER IX.

PROJECTILES.

A particular design of shell only gives its maximum effect against a particular target and under particular conditions of range and angle of impact. Purely theoretical considerations therefore tend to introduce unlimited numbers of types of shell to be used in various circumstances.

Practical considerations are, however, necessarily against this; their tendency being rather towards the introduction of an universal type of shell which can be used effectively against any target.

Neither of these extremes are attainable in practice and a compromise is effected between the two, resulting in a limited number of special types of shell.

Practical considerations, including loading arrangements and stability in flight, were influential in choosing the 4 calibre radius head as the standard.

This was adopted for all heavy guns.

With the adoption of the 4 calibre radius a commencement was made to design all natures of shell of any one calibre of the same weight so that they would range as nearly as possible alike at fighting ranges.

The actual contour of the heads of capped shells of the same size but of different natures, for example, A.P.C. and C.P.C. (for 12-inch guns and above), are not always exactly the same, the length of the ballistic cap being so adjusted as to make the A.P.C. shell range exactly the same at the selected range as the C.P.C. shell, which were already in existence when the new type A.P.C. were introduced. The weights of the A.P.C. shells were also adjusted to give the same muzzle velocity.

During the war H.E. common shells with false ballistic caps of 8 c.r.h. contour were introduced for bombarding purposes, *e.g.*, for Monitors.

The present 3-inch H.E. 16-lb. shell (for the 20-cwt. H.A. gun) and 4-inch Q.F. Mark V shell for H.A. are 6 c.r.h. shell.

With the exception of the special bombarding H.E. shells and the H.E. shells mentioned above, 4 c.r.h. is still the standard contour of Naval shells at present in supply.

Effect of capping projectiles and remarks on the piercing of armour.—These matters are discussed in Volume I of the Gunnery Manual, 1922, and will only be briefly referred to here.

A shell when it hits and perforates through a plate acts mainly as a "punch."

If hard faced armour is hit the shell has first of all to destroy the thin hard face of the plate and then punches out a way for

itself through the thick and tough back. The use of the cap on shells is to assist the shell in the first part of this performance; that is, to break up the hard face of the plate without the head of the shell being shattered in the process.

Under certain conditions of action, caps are useful for this purpose, and all guns down to 5·5-inch have a proportion of capped shells either A.P.C. or C.P.C.

These A.P. caps are fixed over and firmly attached to the point of the projectile in the various ways detailed below:—

Three methods are at present permitted on Admiralty designs.

(1) Notch or thumb mark method in which cap is fixed by indenting portions of lower edge of cap into indents on shell shoulder.

(2) Interrupted ribs on shoulder of the shell, over which skirt of cap is pressed.

(3) A continuous groove is turned on the shoulder into which the skirt of cap is pressed.

Ballistic caps.—The cap proper is surmounted by a thin steel dome called the ballistic cap. This is secured on to the top of the cap proper, and its sole duty is to bring the head to a suitable shape for air resistance. For any particular calibre the contour of the ballistic cap for the various natures of shell may be slightly different to ensure the different natures ranging alike at battle ranges.

Shells thus modified are not “capped shells” in the sense of the A.P.C. or the C.P.C. shell. A ballistic cap of this metal has nothing to do with perforation except indirectly in that it increases the remaining velocity at any given range compared with a blunter-headed projectile.

Bursters of shell.

Originally all bursters of shell were black powder.

High explosive shell fillings, capable of detonation, such as lyddite, were introduced about 1900.

T.N.T. was substituted for some fillings instead of lyddite at a time when difficulty was experienced in obtaining a varnish for the interior of the shells that was free from lead. Lead in the presence of picric acid (lyddite) produces dangerously sensitive picrates of lead.

T.N.T. is used as the filling for H.E. shells, 12-inch and above. These largest H.E. shells are only kept for special issue for bombardment purposes. No guns larger than the 7·5-inch carry H.E. shells for their outfits (except submarines).

Although the term H.E. was applied only to nose fuze common shells filled with H.E. (lyddite or T.N.T.), the pointed shells such as A.P.C. and S.A.P., which are now filled with high explosives (shellite and lyddite) respectively, are equally “H.E. shells.”

Owing to the unsatisfactory behaviour of lyddite as a filling for A.P.C. shells a new filling known as "shellite" was introduced, and this is now the filling in general use for all H.E. filled shell, except S.A.P. and nose fuze H.E.

Remarks on the different fillings, fragmentation, &c.

Powder.—A very satisfactory fragmentation is obtained with powder fillings in C.P. and C.P.C. shells. Large fragments capable of doing severe damage within the cone of dispersal are produced. The velocity of the fragments imparted by the explosion of the powder is low compared with that obtained by a burster of H.E. In consequence of this the effect of powder-filled shells is entirely forward within a cone whose angle is reduced as the striking velocity of the shell is increased. Also powder fillings, as before stated, are not insensitive and therefore will not carry through any but the thinnest armour.

High Explosive.—Effect of detonation of H.E. fillings in A.P.C. or other shell in fragmentation into innumerable small pieces which are propelled with a very high velocity. Where complete detonation is obtained an effect is produced all round the point at which the shell bursts. The extreme violence of the detonation produces immense shattering effect in the immediate vicinity of the burst. The small size of the fragments, however, results in their quickly losing their velocity, with the result that their effect is very much localised. Also the sensitiveness of lyddite to the shock of impact renders shell thus filled ineffective for the attack of thick armour.

C.P.C. projectiles.

Common pointed capped shell (C.P.C.).—These are large capacity shells used for 5.5-inch guns and above, and are for use against unarmoured ships and other light targets. The caps give a certain amount of penetrating power, but these shells will not pass intact through any but thin side plating. If they are filled with powder the filling will often explode on the shock of impact. This type of shell is, however, now obsolescent.

Cracking of C.P.C. shells. Fitting of containers.—Owing to the method of manufacture, spontaneous cracks are possible. To avoid danger from this cause the bursting charge is put in a container. This container is expanded into the cavity of the shell. The base adapter is made the full width of the cavity to facilitate this operation. Containers for powder-filled shells are of copper, and for H.E. fillings of aluminium.

Powder-filling for C.P.C. shells.—This consists of a mixture of pebble powder with fine grain powder called "pebble mixture." The powder burster is contained in a dowlais cloth bag, the choke of which is surrounded by 7-drm. primers, the whole fitting over the fuze in the base of the shell.

Shellite filling for C.P.C. shells, 7·5-inch, 6-inch, and 5·5 inch.
—C.P.C. shells for 7·5-inch to 5·5-inch guns for certain classes of ships are being converted from powder to shellite filling.

Common pointed shell (C.P.). (Plate 19.)

These are obsolete for guns above 4·7-inch and are obsolescent for guns 4·7-inch and below, as they will ultimately be replaced by S.A.P. They are made of cast steel, with the exception of 3- and 6-pdr., which are forged.

In general, common pointed shell are about 3·5 calibres long, ogival heads struck with a radius of 2 or 4 calibres, the walls being about $\frac{1}{4}$ th the diameter in thickness.

They are coated internally with a special paint—earlier shell were lacquered.

With the exception of the 12-pdr. Q.F., they are fitted with dowlais burster bags, the necks of which are primed with a number of 7-dram primers.

In the latest C.P. shell the primer consists of a bag formed of two thicknesses of red shalloon cross stitched, forming compartments between the two thicknesses for powder. Thus the primer fits over the head of the fuze and provides a complete layer of powder round the magazine of the fuze.

They are filled with "P. mixture," with the following exceptions:—

12-pdr. to 6-inch may be filled with "shell Q.F. and shell F.G." instead of "P mixture."

4-inch heavy Mark II is filled with "Blank L.G."

Armour piercing projectiles.

Armour piercing capped shell (A.P.C.) (Plate 20.)—In these shells a large bursting charge has to give way to the necessity for strength in the body of the shell; hence the comparatively small bursting charges used.

A.P.C. shells are shorter than the comparatively thin walled C.P.C. shells of the same calibre and weight.

Within the limits laid down the exact overall length of the shell is left to the contractor.

Spontaneous Cracking.—Hardened shells are liable to crack spontaneously from the strains set up in the metal during the hardening processes. Should such a crack extend into the cavity of the shell the heat engendered at the moment of cracking might cause an explosion of the burster: for this reason A.P.C. and C.P.C. shells are stored for three months before being filled to allow latent cracks to develop. The firing of a shell already cracked would be very liable to lead to the breaking up of the shell in the bore, which would certainly destroy the inner "A" tube of the gun and might have very much more serious effects. Hence great care is necessary that the periodical examination of A.P.C. and C.P.C. shells and caps is strictly and thoroughly carried out.

4 INCH C.P. SHELL.
FILLED POWDER.

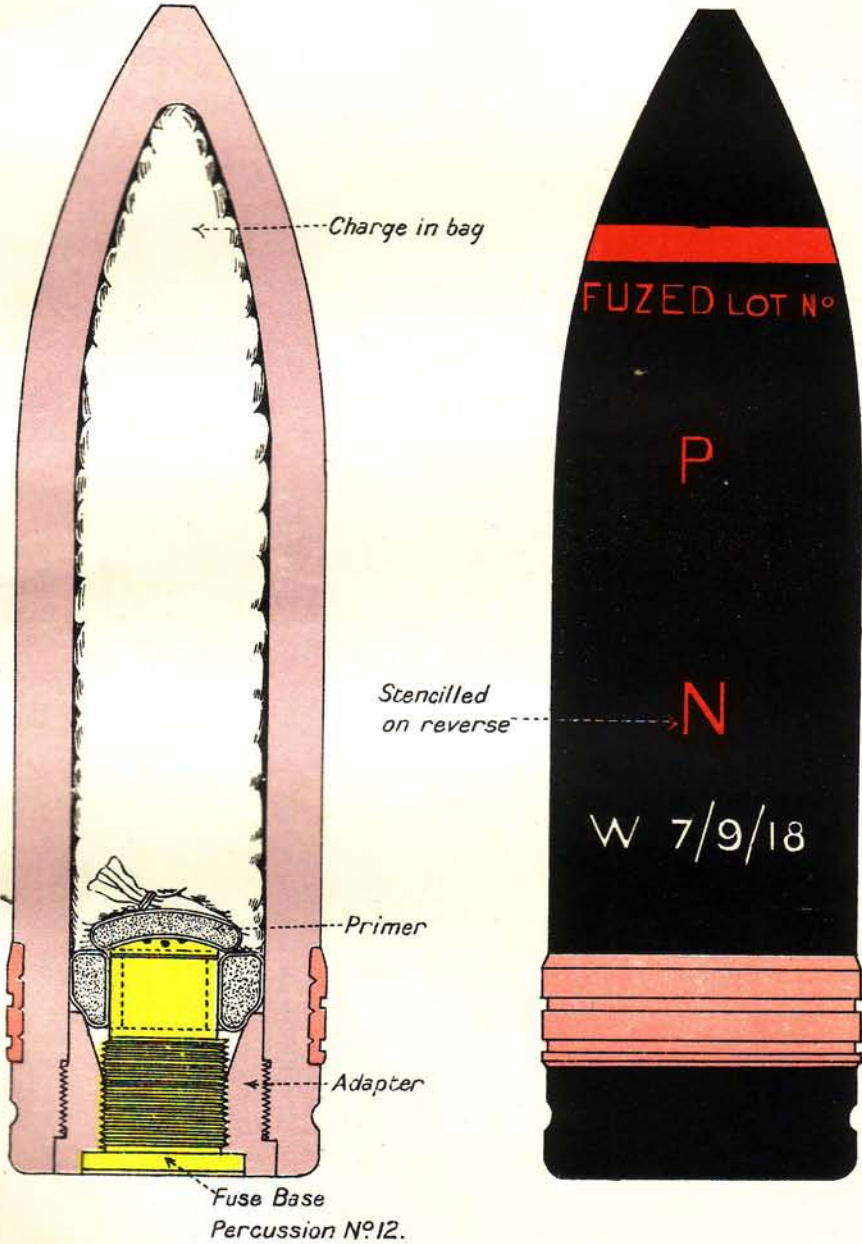

A. P. C. SHELL.
FILLED SHELLITE.

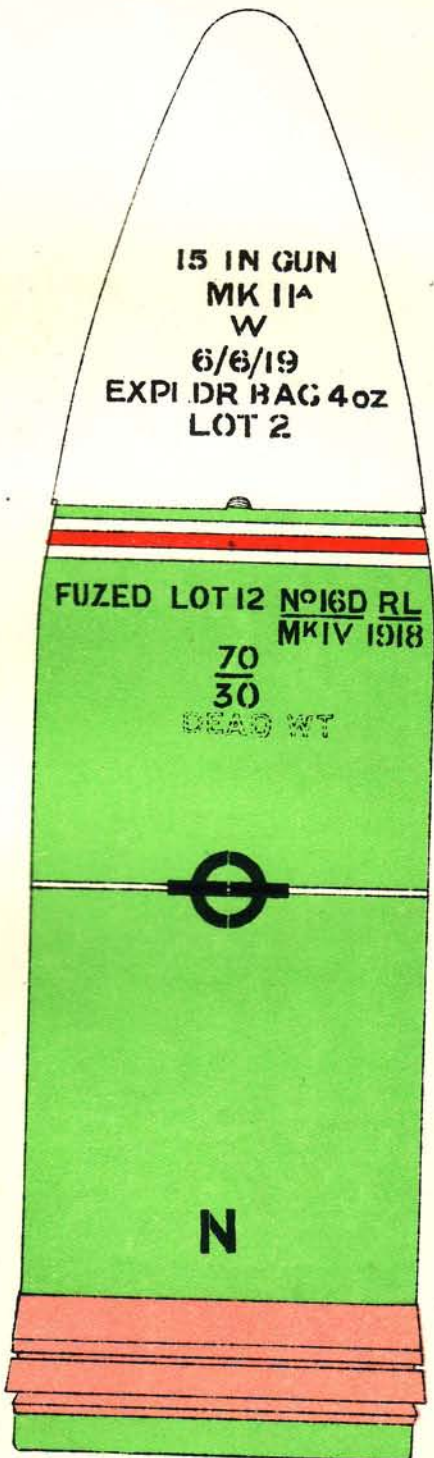
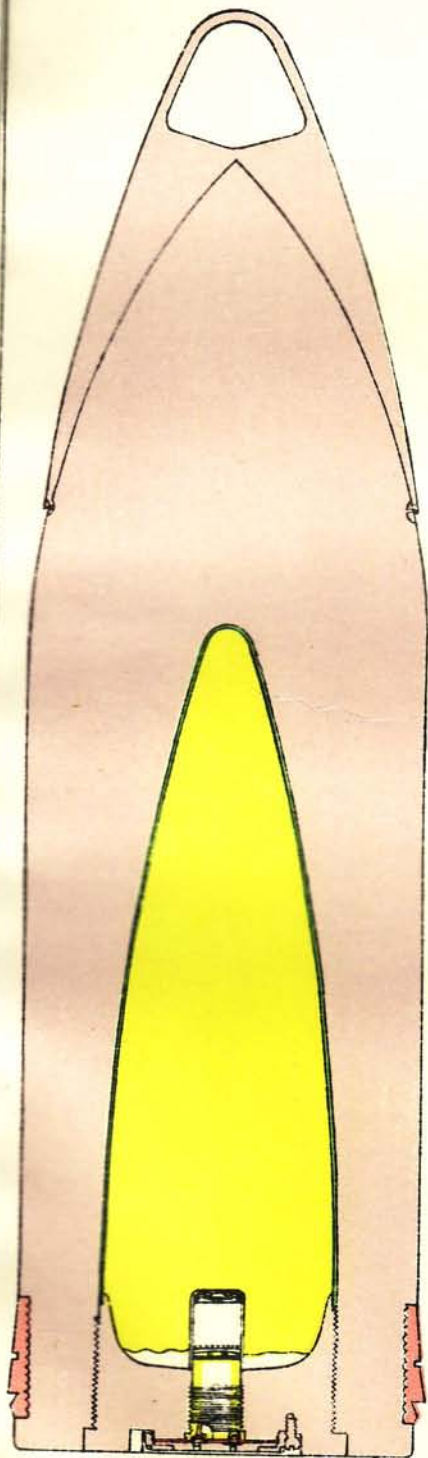

**SHELL 4.7 INCH S.A.P. FILLED LYDDITE;
FUZED N° 12 N. SPECIAL.**

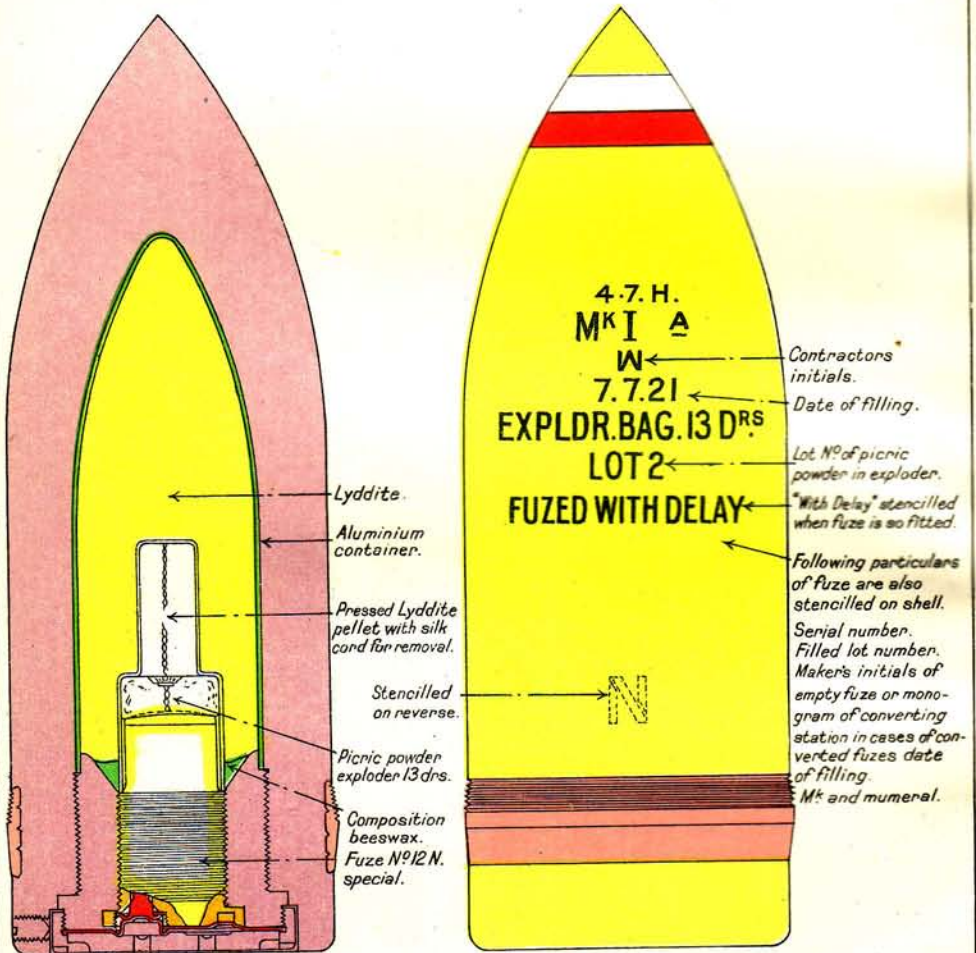

Great care in handling these projectiles is necessary as rough usage may damage the caps.

The cavity, which in most of these designs of shell is wider near the base than elsewhere, is closed by an adapter which is slightly larger than the maximum diameter of the cavity. This arrangement simplifies the fitting of the container.

All A.P.C. and C.P.C. shells filled with lyddite or shellite have an aluminium container expanded into a cavity to receive the filling. This is provided to reduce the liability to explosion due to "set up" on impact and to minimise the risk of ignition of the burster by spontaneous cracking of the shell body after filling.

Gas check on the base.—In order to guard against the intrusion of gases into the shell cavity past the threads of the base fuze, all A.P.C. shells have a copper gas check fitted to the base, completely covering the base fuze. This gas check is shaped to the base of the fuze, an indentation being formed in it to bear immediately on to the pressure plate.

The gas check is held in place by a "base cover plate" and screwed ring.

Manufacture of A.P.C. shell.—The shell bodies are produced from ingots of steel by forging and punching. The bodies are then hardened, heat treated, tempered and annealed, &c., by processes the details of which vary with each firm.

The shell bodies are then hot and cold water tested. This weeds out any shell in which a liability to crack has been induced by the strains set up under the treatment.

The shell bodies are then ground to correct dimensions, grooved for the driving band, and prepared for the attachment of the cap and are bonded into "Lots."

Adapters are made of forged or rolled bar steel so that the axis of the shell is at right angles to the fibre of the original ingot. They must comply with certain tensile tests.

The shell bodies with the caps separate and adapters are bonded into lots of 400, divided into sub-lots for purposes of "proof." The size of sub-lots varies with the calibre of the shell.

Before being sent for filling the shells undergo a three months' keeping test to eliminate any shells that crack during this period.

Semi A.P. shells.

These are pointed shells with a larger burster than the A.P.C. capacity and are filled with H.E. They were introduced during the war for use against submarines, from 4.7-inch guns and below. (Plate 21.)

Being filled with H.E. they have aluminium containers.

S.A.P. shells fired at trials have proved to be superior to C.P. shells filled with shellite or powder for the 4.7-inch, 4-inch,

and 12-pdr. guns against light targets such as destroyers, and the C.P. shells are gradually being replaced by S.A.P. for these guns.

They also have some power of perforating thin armour without breaking up, which the C.P. has not.

Lyddite common shell (nose fuze).

These shells are for use against unarmoured targets for bombardment, or for H.A. fire, and until lately were all fuze with a detonating nose fuze. If complete detonation is obtained the shell is broken up into a vast number of small fragments very effective against personnel, but only of local effect on ships' structures.

The effect of a lyddite common burst against a thin plate is to blow a large hole in the plate.

There is little incendiary effect, and the effect of the fumes is small.

Detonation is indicated by the bursting shell spreading its fragments over a large area, giving an all-round effect, and by the smoke being black to grey, or even nearly white. The latter appearance is due to the steam produced, which shows up more clearly under certain atmospheric conditions.

Yellow smoke denotes simple explosion, and the effect is not so great as regards the spread of the fragments.

The proportion of yellow smoke to that of black, grey or white may therefore be taken as a guide to the degree of the detonation.

Certain so-called "thick-walled" designs of H.E. common shells for 4.7-inch and 4-inch guns have been introduced during the war. The idea of this is that the shell shall give larger fragments than those obtained from the ordinary designs. Such shells are therefore more likely to be efficient for damaging the pressure hull of a submarine when the shell bursts inside the superstructure, or for causing structural damage to a ship.

Remarks on H.E. nose fuze, Common Shells and their fuzeing and use.

At present ships are only supplied with H.E. shells for 7.5-inch guns and below (except submarines). With the exception of shells supplied for H.A. purposes, bombarding or barrage fire and H.E. shells for 6-pdr. and below, H.E. common shells are now being fuzeed with a powder-filled fuze. The powder-filled fuze is used instead of the detonating nose fuze in order that the shell may carry through and burst with violent explosion just inside the ship's side, instead of detonating immediately the plate is struck.

No. 18 P fuze was originally introduced for use in H.E. common for 4.7-inch and below, used against submarines, but its use has been extended to H.E. 7.5-inch, 6-inch and below for the reasons stated above.

6 IN. H.E. SHELL FILLED LYDDITE AND FITTED FOR NIGHT TRACER

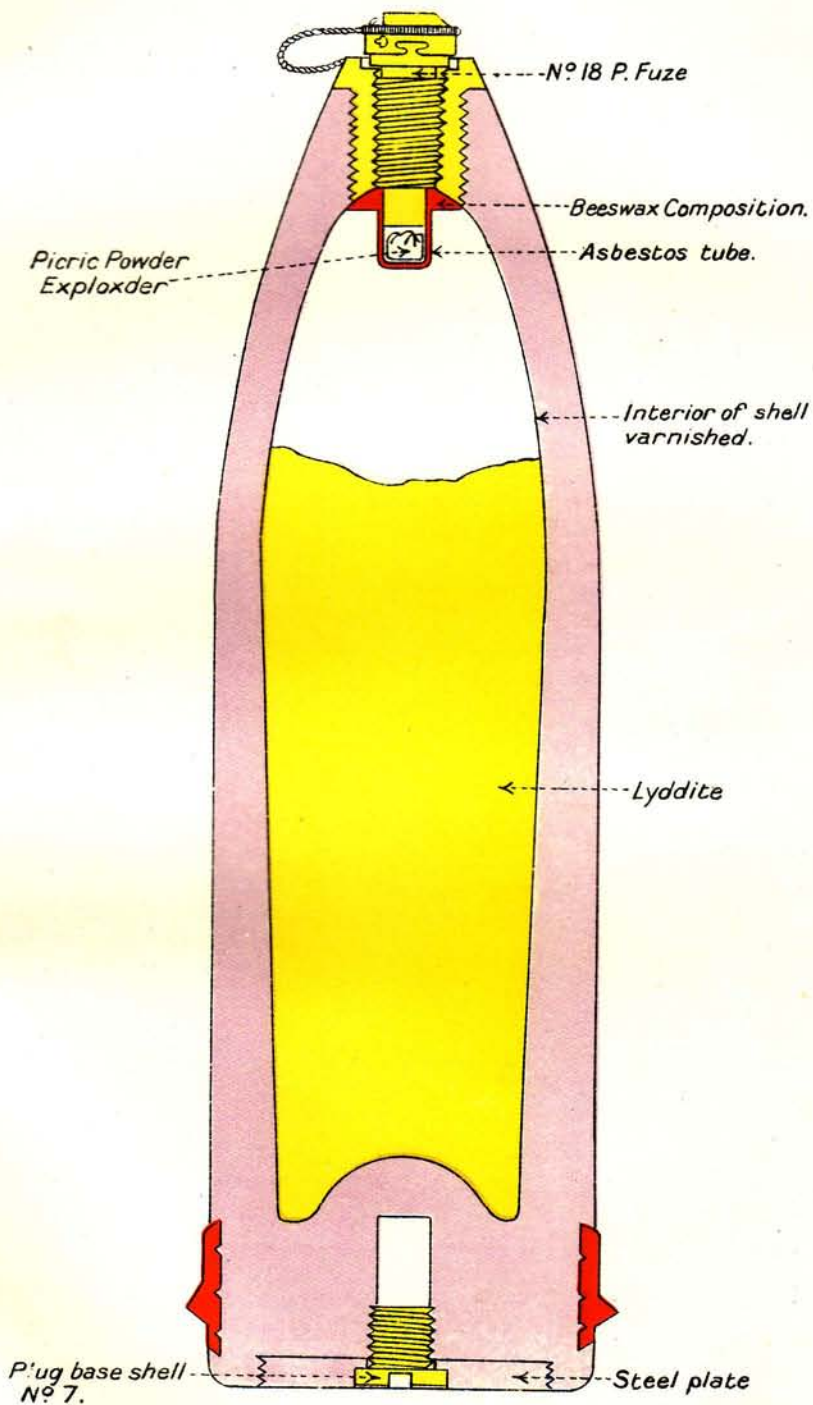

H.E. shells for 3 and 6-pdr. guns and below are not being fuzeed with powder fuzes but will retain their detonating type of fuze.

H.E. common shells for H.A. fire are fuzeed with time fuzes such as the No. 80/44.

The No. 18 P fuzes are being replaced by No. 45 P.

T.N.T. Common Shell (nose fuzeed).

These shells only differ from Lyddite Common in the filling, and their effect is similar when a detonating fuze is employed, but inferior if a powder filled fuze is used.

H.E. Common Shell for guns above 7.5-inch are only filled T.N.T. and are always fitted with detonating fuzes.

Shrapnel shells.

This shell is intended for use against exposed personnel of destroyers or against troops ashore. It may also be used against low flying aircraft by turret guns.

It consists of a steel case filled with balls, which are driven out as from a gun when the shell bursts. These balls travel on for one or two hundred yards after the shell has burst, spreading out in the form of a cone. The shell case, checked by the explosion, falls to the ground.

To obtain satisfactory effect with flat trajectory guns the shell must be burst quite close above the ground within a hundred yards of the target.

The size of the balls has been determined according to the requirements of the shell, bearing in mind that large numbers are needed for a dense distribution throughout the cone, and that the heavier the balls the further they travel and the harder they strike.

Spent shrapnel balls of small size have scarcely any penetrating powers and are often stopped by the men's clothing, canvas weather screens, &c.

Shrapnel shell are manufactured for all 12-pdr. guns and above. A certain number are issued for use with all guns from 12-pdr. 4-cwt. and above.

The remaining stock are kept at the Naval Ordnance Depôts, and are maintained in a serviceable condition for issue, if required, for special operations.

Shrapnel shell are made of forged or cast steel. The shell is burst by a time fuze which ignites a small burster situated near the base of the body.

General construction.

Head.—Most shrapnel have the head made in a piece separate from the body; this separate head is filled up with a block of wood and is lightly secured to the body by a row of rivets and

a row of twisting pins, the head being slotted so that the twisting pins offer no resistance to the head being blown off.

A band of solder round the outside of the shell at the junction of the head and body covers the rivets and twisting pins.

Some small modern shrapnel have no separate head, *e.g.*, the 12-pdr.

Socket or fuze hole bush.—All shrapnel have in the head a socket for the fuze to screw into; this socket is secured to the head by screwing in, or by solder or by both.

Bursting charge.—Shrapnel have the bursting charge in the base. It is usually of loose fine grain powder in a tin cup. Some of the latest small shrapnel for Naval Service have a burster of compressed powder.

A central tube conveys the flash from the fuze to the charge. In most shells this tube is empty, but in some small modern shrapnel it is filled with perforated pellets of powder. This is done with the object of increasing the angle of opening.

The powder is prevented from working up into the fuze hole and threads by a small disc of cardboard, having a hole in the centre covered with shalloon. This disc is placed immediately under the fuze plug and is called the "2-inch fuze hole wad."

The walls of the shell are lined with brown paper, and the balls are placed in. Melted rosin is then poured in between the balls, which, when it solidifies, serves to hold them firm. In all shrapnel the weight of the balls is taken on a steel or metal disc, and not on the cup holding the bursting charge. The latest heavy shrapnel shell have "stepped walls," *i.e.*, the walls decrease in thickness by steps as they approach the head. The object is to give the greatest possible capacity for balls without dangerously weakening the base.

Plate 23 shows a shrapnel shell for 12-inch. With the exception of the stepped walls, this is representative of all shrapnel down to the 6-inch.

The bursting charge consists of R.F.G.² powder, the amount varying according to the size of the shell.

Plate 24 shows the shrapnel shell for the 12-pdr. It has not a detachable head, and the fuze hole bush is only secured by a few threads. The central tube is filled by compressed pellets of powder, and the bursting charge also consists of pressed pellets. To allow of these being put in, the base is detachable, being screwed on and held with a set screw.

It is designed for a 2-inch gauge fuze.

The 4-inch heavy Mark I is very similar to the 12-pdr. as regards the screwed base and pressed pellets of powder. It has a detachable head, although not filled with wood, as in the larger ones. The head also has four saw cuts in it to facilitate breaking up.

12 INCH SHRAPNEL SHELL.

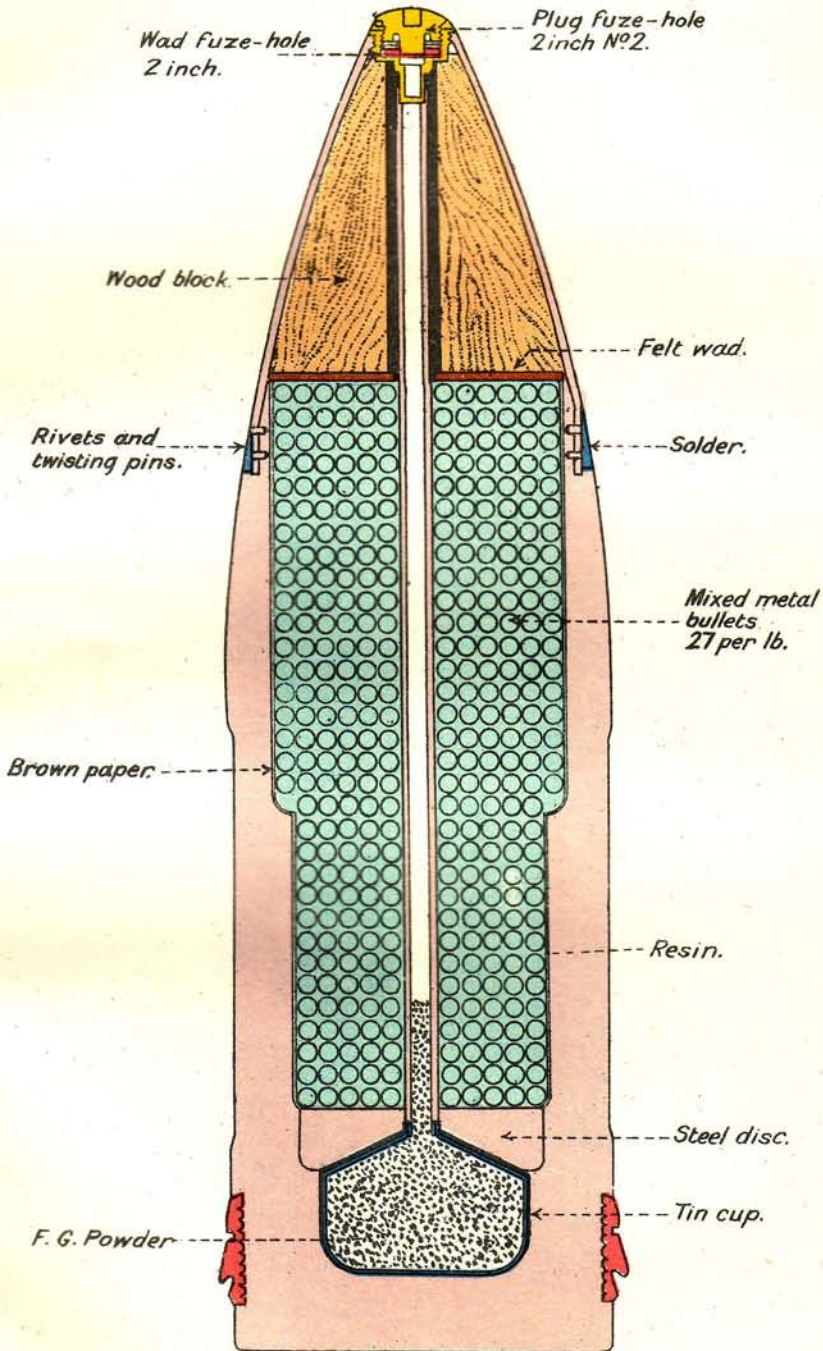

12 PDR SHRAPNEL SHELL.

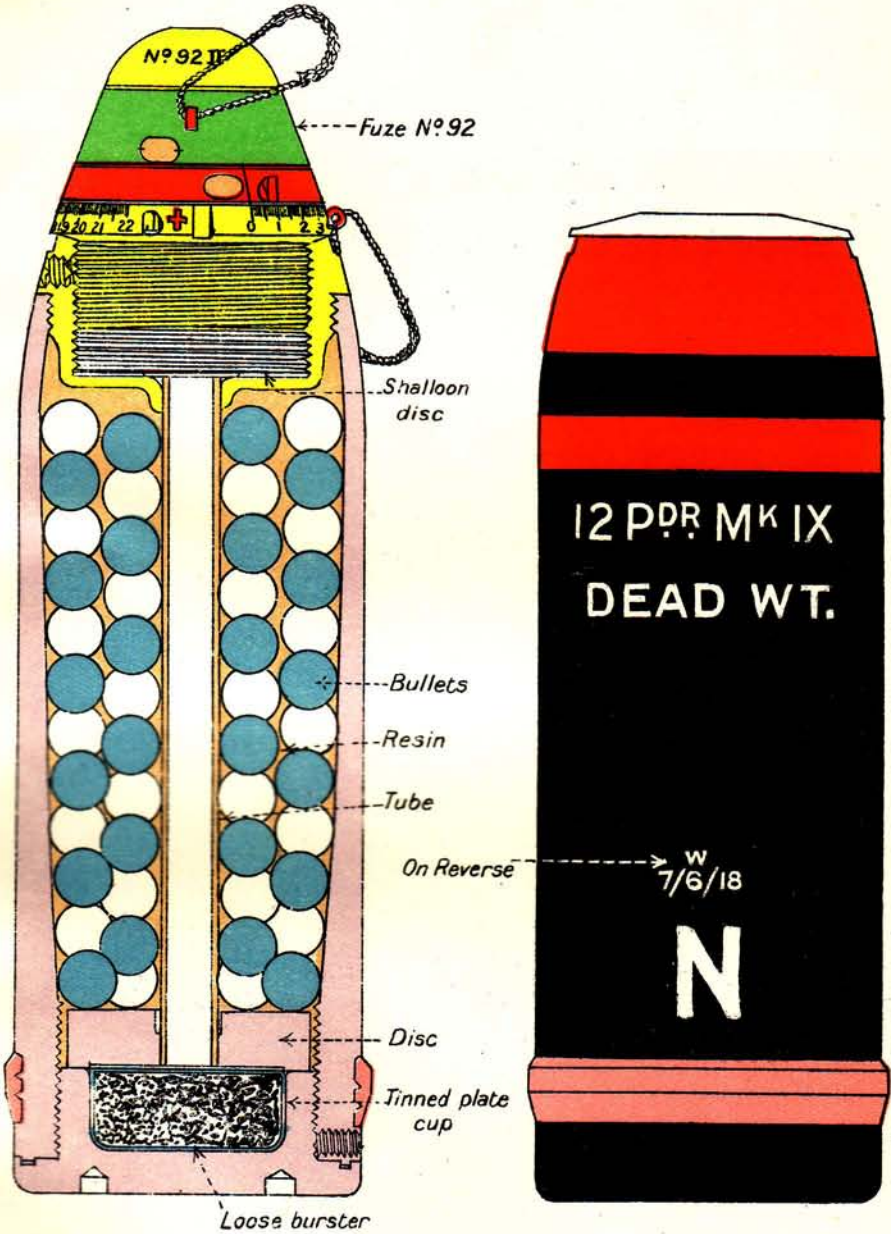

4 INCH STAR SHELL.

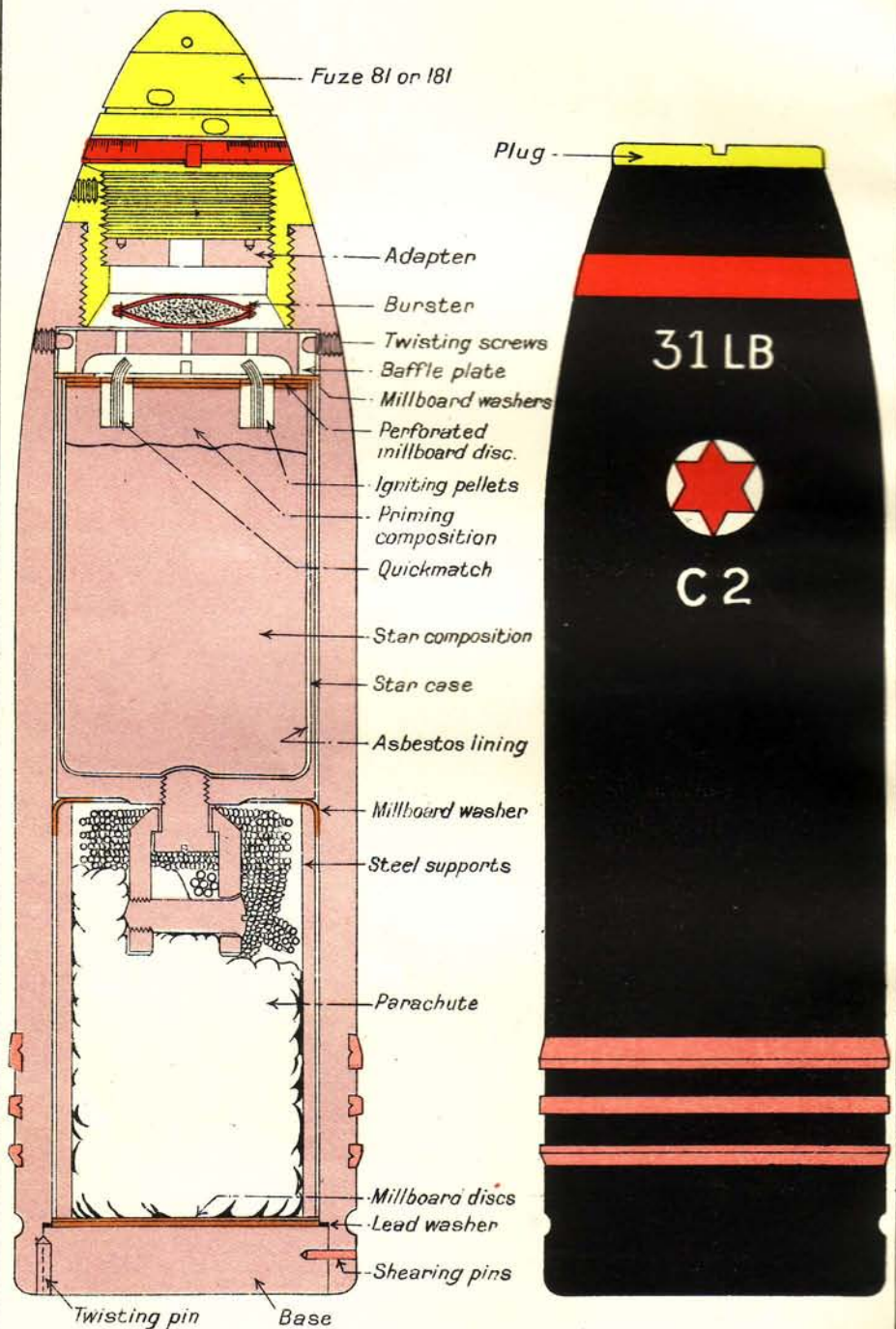

Star shell.

These are designed to throw out a mass of burning composition calculated to give out a brilliant light for as long a period as possible. The star is supported in the air by a parachute.

The shell shown in Plate 25 is typical of the new type of parachute star shell issued for 6-inch guns and below.

The shell is fitted with a burster in the head, supported on a baffle plate, which is held stationary in the shell by means of set screws. Below the baffle plate is the star, consisting of a steel case filled with star composition, with priming composition at the top, into which are set igniting pellets containing strands of quick match.

To the bottom of the star case is fitted a swivel, which forms the means of attachment for the parachute below.

The parachute is made of fabric strengthened by means of wire rope, and a series of wires are connected to a grommet which is attached to the star case swivel.

In certain earlier shells these swivels failed, and in consequence later designs have stronger swivels.

The parachute is folded up and pressed into the shell, the base of which is closed by means of a steel-base, fixed with shearing pins and prevented from rotating by a twisting pin. A lead washer makes the joint between the base and the body of the shell.

The set back of the star is taken on the base by means of a steel support in halves.

The shell is fitted with a time and percussion fuze, No. 81, or time fuze, No. 181, which is set to give the required range.

Action.—On the fuze functioning at the set time, the magazine of the fuze ignites the powder burster below, which sets up sufficient pressure to shear the copper shearing pins and at the same time ignite the igniting pellets and priming composition of the star. The star and parachute are ejected from the base of the shell, and the parachute opens out, rights itself, and allows the flaring star to fall gradually to the ground open end downwards.

Star shells vary slightly in weight.

Approximate times of burning of the present star shell in supply are :

6-inch	about 60 secs.
4.7-inch	„ 45 „
4-inch	„ 40 „
3-inch	„ 24 „

The present designs of star shells are not strong enough to stand the chamber pressure of full charges. Special reduced charges are therefore used with them. It is probable that these shells will be replaced by improved patterns which will enable the ordinary full charge of the gun to be used and avoid the present complication of charges.

Smoke shell.

Smoke shell were introduced during the war for the purpose of creating an offensive or defensive smoke screen.

They were not very satisfactory and have been "scrapped." Improved patterns are being considered but are not yet available for supply.

Target smoke shell.

Target smoke shell are supplied to provide a puff of smoke in the air which can be used as a target for high angle fire.

The 4.7-inch and 4-inch design are similar to the smoke shell, but in the case of the 3-inch design there is no steel container. The phosphorus in this design is held in a tinned plate annular container, which is inserted into the shell and rests on a thick felt washer. The gaine and exploder are inserted in a small container, which fits into the central cavity formed by the annular container.

Practice projectiles.

Practice projectiles are manufactured for all guns; they are made of iron or steel.

Certain 15-inch practice projectiles have been designed with ballistic caps so as to make them range with Service projectiles.

Certain projectiles originally made as explosive shell are condemned and used as practice. These shells are emptied, brought up to weight by being filled with inert matter of the same density as the original filling, and plugged.

Projectiles sentenced to be used for practice, having base plugs, will, before being fired from 12-pdr. Q.F. guns and above, have the keyhole filled with a wood plug to prevent the metal lids of Q.F. cartridges adhering to the base of the projectiles.

Some practice projectiles are supplied for use as "Loading Teachers." These should not be used for any other purpose.

Night tracers.

A night tracer consists of a device for fitting in the base of a projectile, which, on discharge of the projectile from the gun, burns with a bright light.

External night tracers are used with fixed ammunition, and internal night tracers with separate ammunition. They are similar in operation, only differing in the method of attachment to the shell.

Experiments are being carried out to produce a combined base fuze and tracer, and it is hoped shortly to be able to bring out a successful design of this nature.

Night Trace Mark III. (Plate 26.)—This mark is the approved design for both external and internal night tracers of future manufacture.

The tracer consists of a body, and cap with brass sealing disc.

PAGE 72. practice projectiles,-

A new type of practice projectile is being introduced for the 15in. 8in. and 7.5. guns for practice firings against ships targets.

For 8in guns the new type of projectile is supplied for all practice firings at which the use of practice projectiles is authorised. For other guns affected, of projectiles of the new type will be included as the annual allowance of practice projectiles.

Note:-The supply of 16in Target ship projectiles will be considered when experience has been gained with the new projectiles.

These projectiles will be designated "projectiles, ship practice" and will be painted and marked as follows:
BODY.....Black.

DISTINCTIVE MARKING. 2 yellow bands, one on each side of centre of gun.

" STENCILLING. ... To be fired with reduced charges only. On cylindrical portion of body only, the words "PRACTICE" are stencilled circumferentially in black ink in front of driving band.

Note:-Up to the present, the stencilling referred to has only been applied to 15in projectiles, the 8in and 7.5. being fired with full charges. (Ammunition Pocket Book.)

A. F. O. 850/1929.

NIGHT TRACER INTERNAL MARK III.

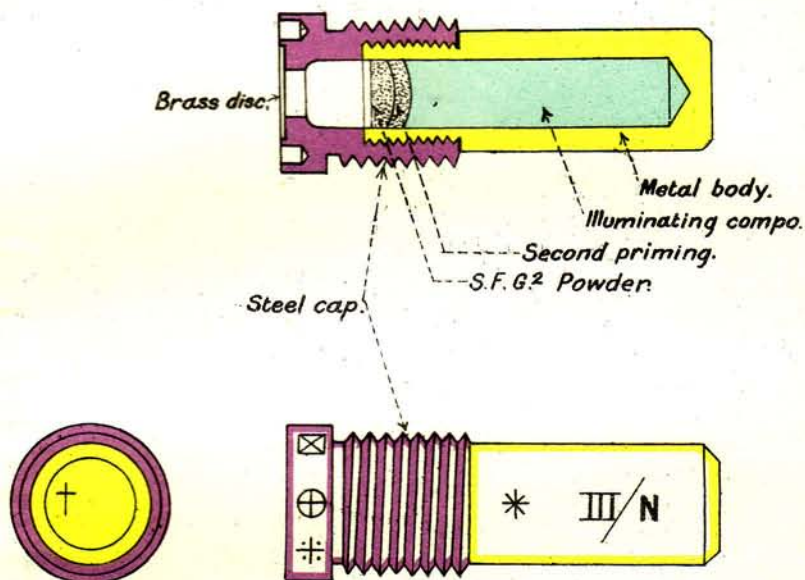

TRACER, SHELL, NIGHT, EXTERNAL, MARK III.

* Contractor's initials.

† Date of manufacture.

⊠ Lot number.

⊕ Date of Filling.

⊞ Monogram of Filling station.

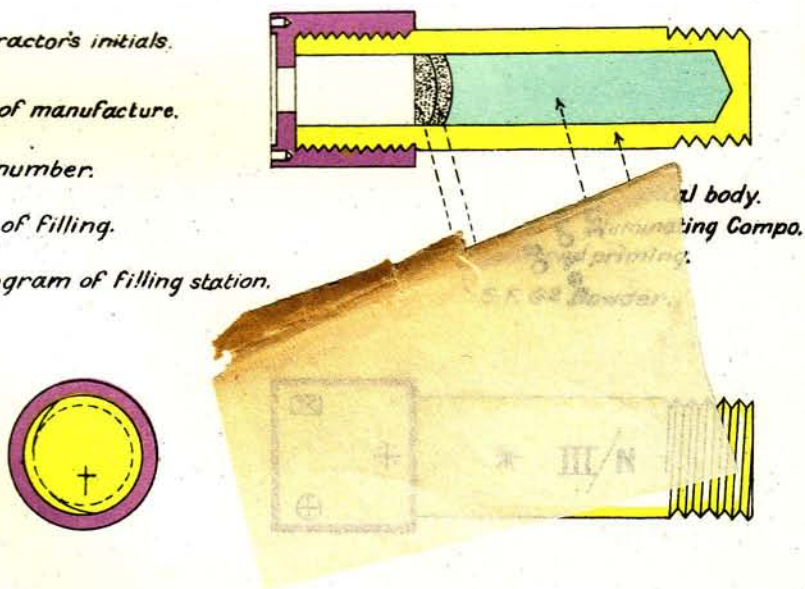

The body is made of metal and is bored out to receive the filling. The rear end is screw-threaded externally for the cap.

The cap is made of steel and is bored out in three diameters. The front end is threaded internally to screw on to the body.

In the case of internal night tracers the cap is threaded at its front end to screw into the base of the shell. In external night tracers, the body is threaded and screws into the shell. A slight recess is formed in the base of the cap and into this the brass sealing disc, .005-inch thick, is lightly sweated. Two holes are drilled in the base of the cap into which the inserting key takes.

The filling consists of 83 grs. of tracing composition, S.R. 190, which is inserted into the body under pressure.

On top of the tracing composition is pressed 4 grs. of priming composition, which consists of an intimate mixture of 70 parts tracing composition and 30 parts S.F.G. meal; 4 grs. of S.F.G.² powder are then inserted on top of the priming composition, also under a large pressure.

After filling, the exterior of the cap is painted black with a lead-free paint. *

Action.

On the gun being fired, the gases generated break down the brass sealing disc and ignite the S.F.G.² powder. This in turn ignites the priming composition, which starts the tracing composition burning. The tracing composition burns slowly away during flight and enables the path of the projectile to be observed.

Note.—When projectiles, with which tracers are used, are not fitted with tracers, the tracer recess is to be fitted with a plug.

Driving bands.

The system in use with all B.L. and Q.F. guns for rotating the projectile is that of attaching a driving band of soft metal to the projectile, near to its base. This band is larger in diameter than the bore of the gun, and on the gun being fired, holds back the projectile until sufficient pressure is set up to "engrave" the band—that is, for the band to force the surplus metal, aside and backwards, into the cannellures or hollows behind the gas-check or elsewhere; thus the bearing surface of the band is broadened and compelled to take the shape of the rifled bore of the gun when, as the projectile travels down the bore, the driving edges of the grooves exert a pressure all round the band and cause the projectile to rotate.

Bands must be made of ductile material in order that this may be correctly displaced when the band is engraved. The material must also be sufficiently strong to stand the stress on it under the highest pressure in the gun, and must, from round to round, offer a uniform resistance to engraving so that the ballistics of the gun

U. S. O. U. 5267. Ammunition Pocket Book. 1924.

er. Line 20. Insert.

acers, Marks V and VI. These tracers are similar to
ight Tracers. Mark III, but are filled with an improved
composition, S. R. 247, and are for use as day or night
acers".

are not altered. In addition, the design of the band must be such that provision is made for the displaced material, as otherwise this will be liable to project irregularly from the band and cause a variable resistance in flight. In the earlier designs of gas-check driving bands it frequently happened that on the escape of the projectile from the muzzle sufficient pressure was set up under the pressed down gas-check to raise this until in extreme cases portions of the band stood out at right angles to the remainder. This is termed "fanning" and tends to inaccuracy.

The material used should therefore possess the following qualities:—

- (1) It should be soft enough readily to engage the rifling.
- (2) It should be sufficiently hard to withstand stripping.
- (3) It should have a high melting point.
- (4) It should not be so hard as to throw an excessive strain on the base of the shell when it takes the rifling.
- (5) It should not leave a deposit in the bore or cause smoke.

See Appendix for "decoppering."

Various materials have been tried for driving bands, varying from soft steel to india-rubber compounds, but so far copper remains the best material known and is used almost universally.

In some cases cupro-nickel is used. This was done to increase the pressure behind the projectile. Cupro-nickel is much harder than pure copper.

The driving band should be as near the base of the projectile as possible, it being generally found that the more rearward position of the band gives the more accurate shooting. In practice, however, this is limited by the thickness of the metal behind the band, which is necessary to support the great strain thrown upon the shell, when the band is forced through the grooves, tending to tear off the base.

In fixed ammunition the amount the cartridge is required to overlap the projectile to produce rigidity must also be considered.

Method of attachment.

A groove is cut in the projectile (width and depth, &c., according to specification). Around this groove are waved ribs projecting as shown in the woodcut. This prevents the driving band slipping round. A number of chisel cuts across these ribs allow the escape of air when pressing the bands on. The edges of the groove are undercut to make a firmer attachment for the driving band. These waved ribs are not found in the 3 and 6-pdr. projectiles.

A length of metal from a solid drawn copper tube is cut off and annealed. It is then slipped over the projectile into a position

TYPES OF DRIVING BANDS.

6 IN. AND ABOVE.

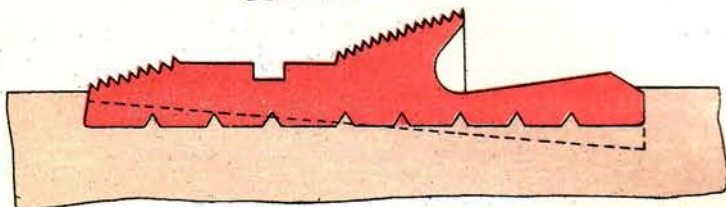

NOTE:— Certain designs of new A.P.C. shell have tapered driving bands the outline of which is shown by dotted line. This modification was introduced to improve the strength of the shell and does not affect action of the band.

7.5 IN. AND 9.2 IN.

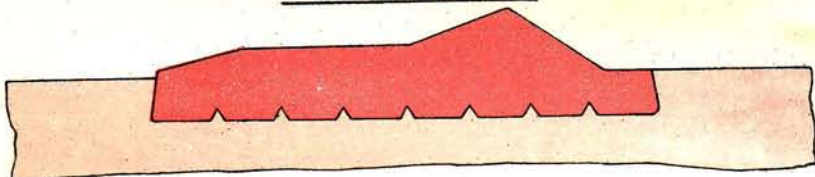

7.5 IN. AND 9.2 IN. PRACTICE.

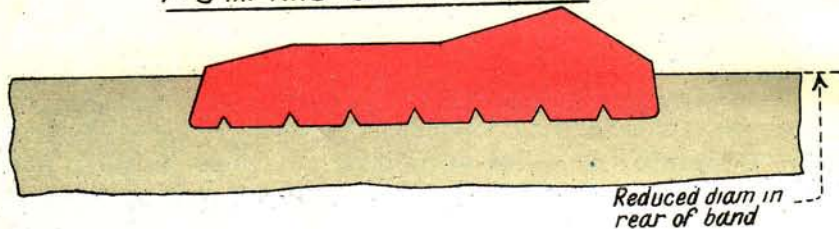

4 IN. AND 4.7 IN.

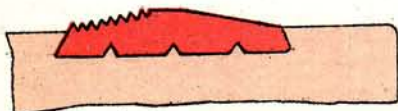

4 IN. "H"

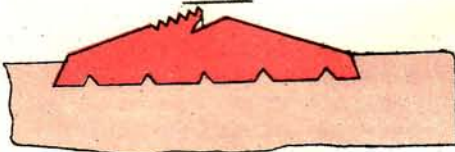

12 PDR

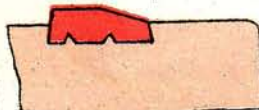

3 AND 6 PDR

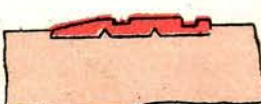

6 IN.

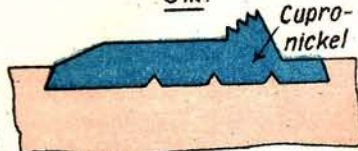

covering the grooved recess round the body of the projectile. The band is then forced into the recess by hydraulic power.

METHOD OF ATTACHING DRIVING BANDS.

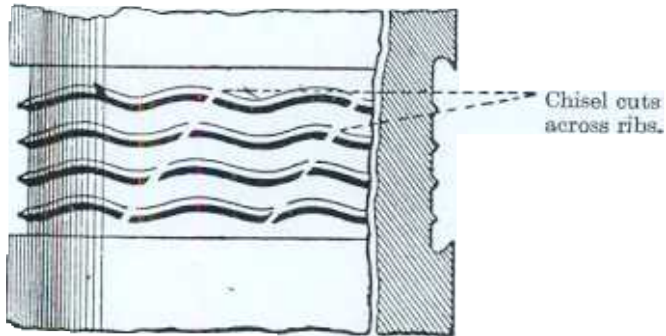

Bands for heavy natures of projectiles are pressed on hot; smaller natures are pressed on cold. The bands are finally turned to the required shape and dimensions.

Shape of the Band.

The first portion of the band should be so shaped as to prevent "over ramming" of the projectile.

The band should be designed to entirely seal windage.

The rear of the band should be shaped to prevent "fringing" or "fanning," that is, the surplus copper is dragged back by the lands of the gun as the projectile passes down the bore and forms a sort of fringe behind the band. When the shell leaves the gun this fringe is no longer supported and the pressure of the gas behind it turns it up at various angles to the axis of the projectile, thus forming variable resistances and causing irregularity of flight.

Types of Driving Band.

Some types of driving bands are shown in the accompanying (Plate 27).

Broad Vavasseur with Gas-check (Modified).

In this type of band the size of the "grave" (the space behind the gas-check slope) is so arranged that the metal of the lip when jammed back by the passage of the band through the gun just fills it, and the rear portion is so sloped away that any tendency to fringe is eradicated.

It is used with 12-inch projectiles and above. Both the front slope and the gas-check slope are serrated.

Driving bands for the latest designs of A.P.C. shell for 13.5-inch to 15-inch are externally similar to the above, but are tapered as regards their inner surface, so that they are bedded deeper

into the projectile near the base than on the forward edge of the driving band. This modification is concerned with the strength and build of the shell.

Cupro-Nickel Band.

The cupro-nickel band is now used with the latest marks of 6-inch B.L. projectiles only. (The 29-lb. cordite M.D. charge was introduced for use with this driving band.)

The band is made of an alloy of 95 per cent. copper and 5 per cent. nickel. It has no cannelures, and the metal in rear of the second slope is not grooved out to form a gas-check lip. Projectiles banded with cupro-nickel are distinguished by having a $\frac{1}{2}$ -inch white band painted round the body immediately above the driving band.

Broad Copper Band ("Hump").

Projectiles fired from B.L. 7.5-inch, Marks I to II** and V guns, are now fitted with this new type of driving band. It differs principally from the gas-check band in having no cannelures, the front slopes are not serrated, the metal in rear of the second slope is not grooved out to form a gas-check lip, and the rear portion of the band is turned down to a diameter slightly greater than the base of the shell.

Broad Copper Band ("Hump"). (For 7.5-inch Practice Shot.)

This band differs from the above in having the cylindrical portion, which is behind the rear slope in the above type, dispensed with. This change in design is necessary with cast iron projectiles so as to leave sufficient breadth of metal in rear of the band to support the strain when the band takes the rifling.

The diameter of the projectile in rear of the band is also reduced by $\frac{1}{10}$ th of an inch, leaving more space for the jamming back of the metal, so as to prevent the base of the projectile from being torn off.

Plain Band.

This type was introduced to supersede the broad Vavasseur band for all natures below the 6-inch calibre. It is of much larger diameter in the centre than the broad Vavasseur band, hence it has no cannelures. It slopes from a short cylindrical portion to the front and rear. The front slope is serrated.

Projectile gauges.

Two gauges are supplied for projectiles of each calibre of gun. They are both in the form of hoops.

(1) The body gauge should pass over the projectile as far as the driving band, both from the nose and the base of the projectile.

(2) The driving band gauge should pass down over the driving band.

Transport of projectiles.

All projectiles 5.5-inch and above are supplied in bulk. Projectiles 4.7-inch and below are packed in boxes which are returned to the depôt when the shells are stowed in the bins of the shell room.

To protect the driving bands of 4-inch projectiles and above, rope grommets are placed over the driving bands. These grommets should be kept in place until the projectiles are required for firing.

Grabs.—Grabs of various designs are supplied for lifting 7.5-inch projectiles and above, in a horizontal position. The supply of lifting bands and the drilling of projectiles for lifting bolts has been discontinued.

Grabs are not intended for embarking or disembarking ammunition except for projectiles over 12-inch calibre, special capstan headed grabs being supplied for this purpose.

Slings.—Wire slings are supplied for the transport of projectiles in cases where it may be required to carry them vertically. Special grabs are supplied for transporting 13.5-inch and above in a horizontal position; 12-inch to 7.5-inch are usually transported horizontally by a hemp strop.

Short slings, which have the metal portions painted black, take the practice shot and A.P. shells. Long slings, which have the metal portions painted yellow, take the remaining natures of projectiles.

Caution *re* Handling Capped Shells of all Sorts.

Whenever shells are being transported, whatever means are used for slinging the shell, the greatest care must be taken that no strain is borne by **any part of the cap**. The caps of shells are liable to be damaged or their attachments to be loosened by any rough usage. The results of such damage or loosening, on firing, may be serious.

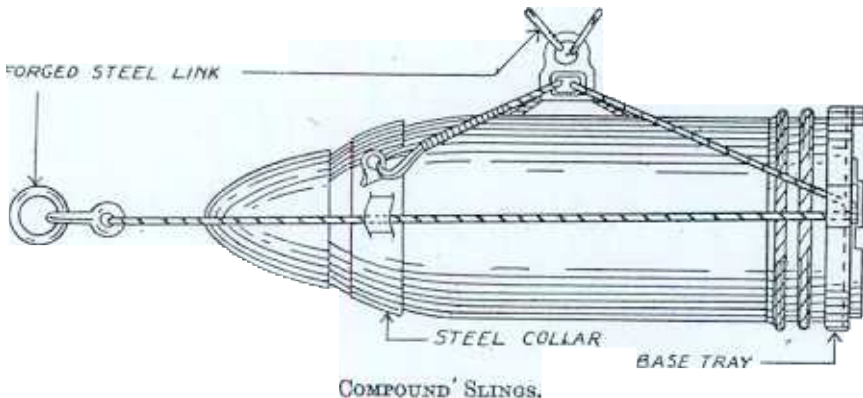

Marking on projectiles. (Plate 28.)

The colouring of various portions of projectiles is a guide to the contents, fittings and uses of a projectile, as follows :—

Coloured portion.	Colour.	Signification.
Tips - - -	Red -	Shrapnel.
Caps - - -	White	Shellite filled A.P.C., 12-inch and above.
	Green	Shellite filled C.P.C., 7·5-inch, 6-inch and 5·5-inch.
Heads - - -	Yellow -	Smoke shell and target smoke shell.
Body - - -	Black -	C.P., C.P.C., powder filled. Shrapnel. C.P.C. shellite, 7·5-inch, to star. Target smoke shell and practice.
	Grey -	Shrapnel and common for 12-pdr., 12 and 8-cwt. only.
	Green -	Shellite filled A.P.C., 12-inch and above.
	Yellow -	H.E. shell filled with lyddite, T.N.T. or amatol S.A.P. filled lyddite.
Rings round head	White -	Semi-A.P.
	Red -	Projectile is filled.
	Two white	Armour piercing.
	Green -	T.N.T. exploder.
	Red criss-cross band.	Amatol filling when pure T.N.T. is used. The fraction denoting the proportions of trotyl and ammonium nitrate is stencilled, e.g., 40/60.
Bands round	Yellow -	Practice (including target smoke shell).
	Green -	H.E. filled with T.N.T. or amatol.
	Black -	On H.E. means shell is empty, used for instruction.
Rings round body	White -	On 15-inch and above, whose bodies are black or green. Joining up centre of gravity mark denotes position of C.G.
Ring above driving band.	White -	Projectile is fitted with cupro-nickel driving band.
Ring below driving band.	Blue -	Improved quality shell.

Stamping on projectiles.

The following stampings are to be found on the sides of projectiles for fixed ammunition and on the bases of the remainder.

1. Calibre and mark of shell (Gun or Howitzer, as the case may be).
2. Manufacturer's initials and Lot number.
3. Date of completion of manufacture.
4. "H" or "L" denoting heavy or light shell where applicable only on separate projectiles.
5. "C.S.," "B.S." or "F.S." for Cast Steel, Bar Steel or Forged Steel respectively. (For shell.)
6. "C.I." for Cast Iron. (For practice projectiles.)

COLOURING OF PROJECTILES.

Practice projectile



Empty Lyddite shell for instructional purposes only

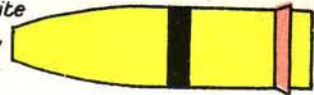

Target smoke shell.



H.E. Shell Filled lyddite

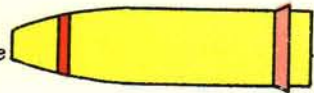

Shrapnel shell



R.E. Shell filled T.N.T.

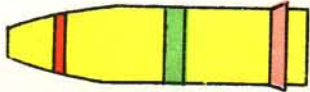

A.P.C. Shell filled Shellite.

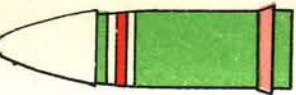

H.E. Shell Filled amotal



Semi-A.P. Shell filled lyddite

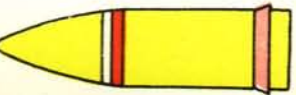

Star shell "A" comp?



C.P.C. Shell filled shellite



Star shell "A" comp?



Strengthened parachute.

C.P.C. Shell filled powder



Shell with cupro-nickel driving band.



NOTE. Star Shell have a Red Star on a white circle on body, with a letter below to indicate the type of Composition used. If a strengthened parachute has been fitted a broken red ring is stencilled round the star inside the white circle.

7. "P" or "A.P.," denoting Practice or Armour Piercing.

8. "A" after the mark of shell denoting 4-calibre radius head. "B" 5-calibre, "C" 8-calibre radius head.

9. "Q" after the mark of shell denoting shell specially made to stand pressure of 6-inch Mark XII gun.

10. "N.T." denoting shell is fitted for Night Tracer.

All shells have the following marks stencilled on their shoulders or caps, if so fitted :-

Calibre and mark of shell. (In the case of fixed ammunition the word "Shell" is stencilled before Mark.)

Initials of filling station.

Date of filling.

Nos. 4, 8 and 9 of the above, where applicable.

"Dead W.T.," when weight filled is within 0.1 per cent. of mean weight (except fixed ammunition), 12-inch shells and above filled lyddite which are not dead W.T. are stencilled with the actual weight to the nearest lb. This weight marking is obsolescent. Shells for future supply being restricted in weight variations, the marking is rendered unnecessary.

"P" or "L.G." for powder filled shell indicating nature of powder, Pebble or Large Grain.

The following markings are stencilled on the body :-

"N" for Naval Service.

"Fuzed," on shells which are fuzed, and the particulars of the fuze. When fitted with a gaine the number is also stencilled on, e.g., "G.2" means No. 2 gaine. 9.2-inch and above have particulars of fuze stencilled on the base as well as on the body.

"~~N~~" when fitted for a night tracer.

"~~T~~" when fitted with a night tracer.

"A" on 3- and 6-pdr. annealed shells.

⊙ in three places on all 12-inch projectiles and above indicates the position of the centre of gravity, to assist in placing on grabs or slings, 15-inch shell and above have the three lines extended to form a line round the body.

"Salt" on plugged shell indicates they are filled with salt for practice.

(P.S.) for powder substitute.

H.E.S. for H.E. substitute

"Trotyl" on the green band round the bodies of shells filled with T.N.T.

"40/60" or other fraction: on a yellow shell with a green band round body denotes amatol filling and the composition.

On a shellite filled shell it denotes the composition of the shellite.

HFO
3143

143

~~N.N.~~ When fitted for a night tracer.

"" when fitted with a night tracer

Page = 79 insert new line 33.

"" when fitted with day and night tracer."

On star shells :—

(I) A red star on a white disc will be found on all star shells.

(II) A red broken circle round the white disc indicates that a strengthened parachute is fitted.

(III) A white letter below the disc indicates the star composition used.

Markings referring to Exploders.—H.E. shells have exploder markings on the lower part of the body as follows :—

“ Exploder T.N.T. Lot.....” For T.N.T. Exploders.

“ Exploder P.P. Lot.....” For Picric Powder Exploder.

Painted markings on the base of shell.

Markings on shell fitted with the following fuzes :—

Non-delay action fuzes, the base protecting plates painted red.

Delay action fuzes, a blue ring is added outside the red protecting plate.

NOTE.—In future the stencilling of fuze particulars will be transferred from the shoulder to the caps of A.P.C. and C.P.C. shell. The stencilling will be black on the white caps and white on the green or black caps.

The markings on the bases of A.P.C. and C.P.C. filled shellite, will be in white in future.

CHAPTER X.

FUZES AND GAINES.

Part 1.—General Remarks.

Caution.—Fuzing shells on board.—The regulations to be observed when fuzing or unfuzing shells are laid down in the Naval Magazine and Explosives Regulations and are not repeated in this handbook.

General remarks.—Shell fillings are ignited or detonated by means of a fuze. This ignition or detonation may occur during flight, on impact, or after impact, according to the type or fuze used.

The following classes of fuzes are used in the Naval Service :—

- (i) Base Percussion Fuzes.
- (ii) Nose Percussion Fuzes.
- (iii) Time Fuzes.
- (iv) Time and Percussion Fuzes.
- (v) Hydrostatic Fuzes.

Fuzes may be made to various screw gauges, the most common of which are 2-inch and "G.S." for nose fuzes, and the No. 16 fuze gauge or the No. 12 fuze gauge for base fuzes.

The G.S. fuze hole gauge tapers from 1·23-inch from the top.

Percussion Fuzes function as a result of the projectiles, in which they are fitted, striking any object offering sufficient resistance.

Time Fuzes.—The action of time fuzes is initiated by the shock experienced on discharge of the gun, but the explosion of the shell filling does not occur until the expiration of a definite period of time dependent upon the position in which the fuze is "set" before firing.

Time and Percussion Fuzes.—In time and percussion fuzes both the above systems are embodied.

The percussion mechanism in T. & P. fuzes causes the shell to burst, should it strike a target before the shell filling has been ignited by the action of the time arrangement.

Percussion Fuzes.—There are two distinct types of percussion fuzes :—

(A) Those which depend upon the forward movement of a "graze pellet" relatively to the main body of the fuze. Such fuzes are generally referred to as "Graze Fuzes."

(B) Those fuzes which only function as a result of a direct blow on the nose, a hammer or needle being forced on to a detonator. Such fuzes are generally known as "Direct Action," or in some cases as "Direct Action Impact" fuzes.

Graze Fuzes.

All base percussion fuzes and all time and percussion fuzes embody the "graze pellet" type of percussion mechanism.

The type of percussion mechanism in question involves the use of a comparatively heavy pellet of metal, which is enclosed in a chamber in the fuze, in which it is capable of longitudinal movement towards the front.

This pellet is usually situated in the centre of the fuze and carries at its front end either a detonator or a needle. If the pellet carries a detonator then a needle is fixed to the fuze at the top of the chamber in which the pellet moves.

If the pellet carries a needle then the detonator is fixed to the fuze.

The mechanism of the complete fuze is so arranged that on graze or impact of the shell, the pellet moves forward so that the needle fires the detonator, the flash from which ignites the magazine of the fuze and thus explodes or detonates the filling of the shell. Sometimes a "Gaine" is interposed between the fuze and shell filling.

In order to guard against accidental or premature ignition of the fuze or shell filling, it is essential to introduce certain safety arrangements into such fuzes as are now being discussed.

These safety arrangements are so designed as :—

I. To prevent any possibility of the graze pellet moving forward before the shell, to which the fuze is fitted, has been fired.

II. To guard against ignition of the shell filling should the detonator of the fuze be prematurely or accidentally fired before the shell, to which the fuze is fitted, has been loaded and fired from the gun.

III. To prevent premature firing of the detonator during flight of the projectile and before the target is struck.

In addition the safety arrangements embodied are designed so as to be strong enough to withstand normal rough usage, such as may be experienced during handling and transit of fuzes in the Service.

With regard to (I), this is usually accomplished by locking the pellet in the rear position by means of centrifugal bolts, arrangements being included which do not permit of these centrifugal bolts disengaging before the fuze is fired from a gun. Other means, however, are also employed. For example, in some time and percussion fuzes safety pins are employed which pass through the fuze body and hold the percussion mechanism in the rear position. Such safety pins can be removed immediately before firing.

This system of obtaining safety by means of safety pins can only be taken advantage of in nose fuzes.

Another method of preventing forward movement of the graze pellet before firing is that which is employed in base

Hotchkiss fuzes, and which consists essentially of a graze pellet made up in two parts, one of which has to be forced back over the other before the needle can move forward and reach the detonator. Other devices, such as stirrup springs, ferrules and balls are also made use of for ensuring safety before firing.

It should be remembered that even where safety pins are employed as the main safeguard against forward movement of the pellet, it is necessary to embody at the same time some additional arrangement, which will prevent the pellet moving forward after the safety pin has been removed, so that when the safety pins have been pulled out from fuzes it does not mean that the fuze is dangerous; but in such cases those safety arrangements which remain are not sufficiently robust to prevent the possibility of accident if the fuzes are subjected to rough treatment after removal of the safety pin.

With regard to (II), this is in some fuzes guarded against by introducing a contrivance, such as a centrifugal shutter, which prevents the flash from the detonator reaching the fuze filling. Such contrivances are arranged so that the passage for the flash of the detonator is not opened until the shell ceases to accelerate, *i.e.*, until the shell is clear of the muzzle of the gun.

With regard to (III), the resistance of the air retards the shell during its flight. But since the graze pellet is enclosed in the fuze it is not acted upon by the same retarding forces, and unless some artificial retarding force is introduced the pellet will acquire a forward motion relative to the fuze. This might result in the needle meeting the detonator during flight and so causing a premature explosion of the shell. This forward motion of the pellet, or "creep action," as it is usually termed, is prevented by inserting a spring, usually termed the "creep spring," though a more correct name would be "anti-creep spring," between the front of the pellet and the fuze itself.

Thus, in order to move forward so as to enable the needle to pierce the detonator, the pellet has to compress this "creep spring."

The strength of the creep spring is arranged so that until the forward motion of the shell is violently checked by graze or impact, the graze pellet is always held back on to its seating during the flight of the shell through the air.

In the case of fuzes in which the greatest possible degree of sensitiveness is required, the creep spring is made only just strong enough to hold the pellet back during flight.

The creep spring in some fuzes also assists to prevent premature action due to rebound of the graze pellet on shock of discharge.

In any graze fuze the safety contrivances are so arranged that the pellet is never entirely free to move forward until the fuze has been fired from a gun, and they are made strong enough to withstand successfully such jolts and jars in loading, accidental drops, &c., as may be experienced during handling and transit of ammunition.

It was at one time thought that unless the graze pellet was locked to the body of the fuze circumferentially, there was a tendency for the pellet to screw its way forward against the creep spring during flight, and in some fuzes, therefore, *e.g.*, No. 12, No. 15 and No. 16 types, it will be found that an anti-twisting pin has been introduced, which ensures the pellet turning with the remainder of the fuze.

Actually it has since been found unnecessary to include such pins, but in the three types of fuzes quoted above they must be retained for another reason, since the correct action of those fuzes would not be obtained if the pellets were able to turn in the fuzes.

Direction Action and Direction Action Impact Fuzes.

Both Direct Action (D.A.) and Direct Action Impact (D.A. Impact) fuzes must receive a blow on the nose to cause them to function.

D.A. Impact fuzes, however, require a much heavier blow than D.A. fuzes to ensure the detonator being fired.

Some D.A. and D.A. Impact fuzes are fitted with "shutters," which are interposed between the detonator and the magazine of the fuze; the function of a shutter is to seal the flash of a detonator from the magazine should the former ignite or detonate prematurely.

Shutters are arranged to open under the action of the centrifugal force set up by the rotation given to the shell by the rifling of the gun on firing, this force having to overcome the pressure of a spring which tends to keep the shutter, closed but wherever possible the additional precaution is taken of embodying a safety pin to ensure the shutter being held in the closed position until immediately before loading.

Time, and Time and Percussion Fuzes.

A Time fuze is a fuze which can be set so as to cause the shell to burst at a certain predetermined time after firing.

A Time and Percussion fuze embodies in addition to the above a graze percussion mechanism, which will enable the fuze to burst the shell should the latter strike the target before the time at which the time mechanism has been set has elapsed, or in the event of the time mechanism failing to function correctly.

As regards time fuzes there is at present only one class of such fuze in the Service, and this consists essentially of a body, which contains an igniting arrangement, and which has two "rings," which are filled with time composition, surrounding a central stem. Below the rings is situated a magazine, which on exploding causes the shell to burst, either by direct ignition of the shell filling or through the medium of a gaine.

The time composition is pressed into annular grooves in the time rings, the composition of the powder and the pressure, under which it is pressed into the ring, being adjusted so as to

give a certain definite time of burning, when the fuze is "set full."

One ring is capable of being revolved on the fuze body so as to enable certain lengths of the fuze composition being burnt through before the fuze magazine is ignited, and by this means the fuzes can be set to burn for certain definite times.

The igniting arrangement consists of a pellet which carries either a detonator or a needle (a needle or detonator being fitted to the body of the fuze), and on firing this pellet sets back so that the needle pierces the detonator and fires it. The flash from the detonator ignites the time composition, a certain length of which burns, this length being regulated by the position in which the fuze is "set."

When the correct length of time composition has burnt through, a flash is conveyed to the magazine of the fuze, and the bursting of the shell is initiated.

Time Compositions or Fuze powders.

The compositions which are used for filling the time rings of time fuzes are generally referred to as "fuze powders." These powders usually consist of ordinary fine grain gunpowder, in the manufacture of which specially prepared charcoal is used.

The powders are manufactured in batches, several of which are blended together to form one main batch which, when pressed into the time rings of a fuze under certain specified pressures, gives a certain time of burning. Variations in the time of burning are obtained by using charcoal made from different kinds of wood, and which are converted into charcoal under different conditions, and also by varying the proportions of the three ingredients, charcoal, sulphur and saltpetre.

Charcoals made from hard wood and burnt at high temperatures result in longer times of burning being obtained. A higher proportion of sulphur also effects an increase in time of burning.

The use of charcoal, made from the lighter classes of wood more slackly burnt, results in a faster burning powder being obtained.

Two classes of ordinary fuze powders are manufactured for Naval Service, and are distinguished by being given names indicating the time which such powders take to burn through when filled into the time rings of a No. 80 fuze, the fuzes being fired set full at rest.

The two powders are :—

- (A) 22 second powder.
- (B) 30 second powder.

In order to obtain longer times of burning than it was possible to get using only 22 second or 30 second powders, a "long-burning" powder of special composition is employed.

This special powder is known as "R.D. Composition No. 202."

The combination of 22 second powder and R.D. composition No. 202 was found, however, to be considerably more reliable in respect of absence of blinds when the fuzes were fired at high angles, than was the case with original No. 121 fuzes, and, therefore, all No. 121 fuzes are now being filled with this combination of powders, such fuzes being known as No. 124.

All fuzes of which the lower ring is filled with R.D. 202 composition are distinguished by having that ring coloured red.

Generally, with the exception of R.D. 202 compositions the slower burning powders are more difficult to ignite than the faster burning powders, and also are more liable to stop burning during flight, especially when fired at high angles.

22 second powder and R.D. composition No. 202 are fairly satisfactory in this respect, but the use of 22 second powder alone means a very short time of burning with the result that full advantage cannot be taken of the power of modern guns, while the use of R.D. 202 composition involves a loss of accuracy in respect of the time of burning.

The rotational velocity of a shell and the attenuated pressures experienced at high altitudes both have an effect upon the burning of fuze powders. The higher the spin and the greater the angle of elevation, the longer the time of burning obtained; at the same time both these causes have the effect of increasing the difficulty of the composition in keeping alight. Thus, it is necessary, especially for fuzes for the smaller guns and for high angle ammunition, to utilise either quick burning powders, which contain a comparatively low percentage of carbon in the charcoal used, or alternatively a powder which is very hot burning.

Igniting Pellets.

As explained above, the igniting pellet sets back on discharge of the gun so that a detonator is fired, the flash from which ignites the fuze powder and starts it burning.

This igniting pellet is suspended in its position of rest in different ways in different fuzes.

In some fuzes, *e.g.*, No. 65A, the pellet is supported by a shearing wire, and this wire is sheared by the setback force exerted by the pellet, when the gun fires.

For safety, in order to prevent accidental ignition of the detonator due to rough usage before firing, a safety pin passes through the body of the fuze and supports the pellet in its upper position. This safety pin must be removed before loading.

In other fuzes, *e.g.*, No. 81 and No. 124, the pellet is supported by means of a stirrup spring. Safety pins are sometimes used in conjunction with the stirrup springs, but this is only essential when the stirrup springs are made weak so as to ensure the fuze functioning when fired in heavy shells.

A third method of supporting the igniting pellet is to use a spiral spring, and this method is adopted in No. 84 and No. 92 fuzes. A safety pin must be used in order to prevent the spring being compressed by "jar" due to rough usage before firing.

T. & P. Fuze Percussion Mechanism.

The percussion mechanism of all T. & P. fuzes is of the graze type, but two methods of "arming" mechanisms are employed. For example, in the No. 93 type of fuze the percussion pellet is prevented from going forward prematurely by means of a ball which is interposed between the pellet and the body of the fuze, and which does not allow the needle to reach the detonator. This ball is held in position by means of a "ferrule," and this ferrule in its turn is retained in place by a stirrup spring.

On firing, the ferrule sets back, straightening the arms of the stirrup spring, and leaves the ball free to move outwards into a specially prepared seating. This it does under the action of centrifugal force. There is then nothing to prevent the percussion or graze pellet moving forward except the creep spring.

In some fuzes, *e.g.*, No. 65A, while the ball is still retained to prevent premature movement of the graze pellet, the system of locking and releasing it is slightly different. A "safety pellet" retains the ball in position, and is itself supported by a shearing wire. On firing the setback force causes the pellet to shear the shearing wire, and it drops into a recess leaving the ball free to move outwards. With this device it is necessary to include a safety pin, in order to prevent accidental shearing of the shearing wire.

In other fuzes, *e.g.*, No. 84 and No. 92, the percussion pellet is locked to the rear by means of centrifugal bolts, which become disengaged due to the rotation of the shell after firing.

This has been found an unsatisfactory method of retaining the percussion mechanism in T. & P. fuzes and such mechanisms are being eliminated from the Service. Percussion safety pins are fitted to time and percussion fuzes which embody this type of percussion mechanism.

Safety Pins.—Wherever the safety arrangements embodied in the fuzes are insufficient to ensure that either the time or percussion mechanism is incapable of being set in action before the fuzes are fired from a gun, *i.e.*, by rough handling, dropping, &c., safety pins are inserted from the exterior of the fuze; these pins pass either through components designed to move or between moving parts, with the object of ensuring that no movement can take place until the safety pins have been withdrawn; thus safety pins may be briefly described as a definite means of ensuring safety in storage and during handling or transport.

Clamping or tensioning of time rings.—In some fuzes, the cap is screwed down so that the time rings can only be moved by the application of a certain minimum torque.

At the same time the "tension" at which the cap is screwed down is so adjusted that a certain definite turning moment does not have to be exceeded to turn the rings. Such fuzes are known as "Tensioned Fuzes."

Of Naval Service time or time and percussion fuzes the following are tensioned :—

No. 84, No. 92 and No. 192.

No. 124.

No. 185.

Other fuzes are arranged so that the rings are tightly clamped in position. Such fuzes are known as “clamping fuzes.”

In order to move and set the rings of clamping fuzes the top cap or nut must be eased up, the bottom ring then moved to the required setting, and the top cap or nut then screwed down tight.

The following Naval Service fuzes come under the heading of clamping fuzes :—

No. 65A.

No. 81 and No. 93.

The object of tensioning or clamping the ring of time fuzes is to ensure that the setting is not accidentally altered after having once been put on, and also to guard against any movement of the rings, which might occur on firing, when rotational velocity is imparted to the shell by the rifling of the gun.

Setting of time fuzes.—The length of time composition to be burnt through is regulated by the angle through which the lower time ring is turned.

In order that the ring may be turned through any desired angle, graduations are placed on the body of the fuze and an arrow is placed on the exterior of the moving ring.

The graduations cut on the body do not necessarily represent minutes or degrees of arc, nor do they represent seconds of time, but are arbitrary divisions chosen, so that the requisite degree of fineness of setting may be obtained.

Fuze scales are prepared to indicate the time of flight corresponding to the various settings.

The movement of the lower time ring may be accomplished by hand, a suitable setting key being used, or in the case of tensioned fuzes the setting may also be accomplished by means of either a hand fuze setter or a fuze setting machine.

To enable the setting key or setter to be used slots are formed in the ring, or alternatively, studs are screwed into it.

For hand fuze setting by means of a key the position of the slot or stud is of little importance, but on the other hand, the position of the studs in fuzes, with which either hand fuze setters or fuze setting machines are to be used, is of the greatest importance.

The setting studs, which are usually made of mild steel, are very accurately inserted when the fuze is manufactured, one in the movable ring, and the other in the body of the fuze, and the greatest care must be taken not to damage or distort these studs after issue of the fuzes to the Service. On no account should

the stud provided in the body be used for any other purpose than that for which it is intended, *e.g.*, it must not be used to form a hold for the fuze fixing key.

It should be clearly understood that any damage or distortion of the setting stud entirely destroys the accuracy with which a fuze can be set by a fuze setter.

Exhaust.—A means must be provided for permitting the escape into the atmosphere of the gases formed by the combustion of the fuze powders.

In all time or time and percussion fuzes at present in the Naval Service, with the exception of No. 185 fuze, radial exhaust channels are provided in the time rings themselves, so that the gases generated may escape through these channels into the atmosphere.

Some difficulty was experienced in the past in providing an efficient seal on the exterior of the exhaust channels, which must be closed until the fuze powder actually starts to burn, but this difficulty has been overcome.

Any blocking of the exhaust channels by slag, &c., resulting from the combustion of fuze powder, seriously affects the regularity of burning, so that one of the points to be borne in mind in producing fuze powders is to ensure that the quantity of slag, &c., produced during combustion is a minimum.

In fuze No. 185 an entirely different system of exhaust is embodied, the gases from the burning rings being led through the channels to an exhaust port situated in the nose of the fuze.

This system of exhaust was first introduced by the Americans (No. 185 fuze is an American fuze, the entire stocks of which were obtained from the United States).

It was at one time thought that the failure of British fuzes to burn correctly, especially when fired at high angles of elevation from small guns, was due to the method of exhaust employed. This belief was strengthened by the comparatively satisfactory results which were obtained with the American nose exhaust fuzes.

In the light of later information, however, this view has been somewhat modified, and it has been more or less definitely proved that the principal cause of failure of British fuzes, and also the reason for the success of the American fuzes, was the quality and composition of the powder used for filling the time rings.

Waterproofing of Time Fuzes.

All time fuzes and time and percussion fuzes are supplied with the spaces between the rings, between the cap and top ring, and between the body and the bottom ring, set screw holes and safety pin holes, and also the escape hole discs in time rings, covered with "waterproof composition," and it is essential that this waterproofing should not be destroyed, since it affords a means of enabling the fuze to retain its serviceability for a longer period than would otherwise be the case.

Should, therefore, the waterproofing of any fuze be impaired by the removal of a safety pin or by the movement of a time ring, or any other cause, if not immediately fired, that fuze should at once be regarded as unfit for service, and steps should be taken for it to be returned to the nearest Naval Armament Depôt at the earliest opportunity.

Fuze Covers.

In order to protect fuzes from the effect of damp, it is necessary to cover them after they have been removed from cylinders and fitted to shells, particularly when such shells are placed in exposed positions on board ship.

The most successful device, and that in general use to-day, is known as the "Kit Plaster." This consists essentially of a conical cap of canvas, which is soaked in kit composition and placed over the nose of the fuzed shell. It is provided with beackets and is readily removed without the use of a key or other instrument.

In order to prevent actual contact between the kit composition and the fuze, a paper cap is first of all placed over the fuze.

Kit plasters are not only very cheap to manufacture, but also are less perishable and liable to damage than either brass or rubber covers, and have in addition the considerable advantage that they can be readily replaced on board ship.

Hydrostatic Valve Fuzes.

At the present time there is only one nature of hydrostatic valve fuze in the Naval Service, and this is described in detail on page 106.

A hydrostatic valve fuze is actuated by water pressure and the strength of the hydrostatic valve spring with which it is fitted determines the depth of water through which the fuze must sink before the spring is compressed sufficiently to release the firing mechanism.

Failures and Accidents with Fuzes.

"Blinds" or "Prematures" may occur with any class of fuze.

A blind usually indicates that the main detonator of the fuze has failed to fire in the case of percussion or hydrostatic mechanisms, and in the case of time mechanisms it may mean either that the detonator of the igniting arrangement has failed to function, or that the time rings have failed to ignite, or that having ignited the time ring composition has failed to continue burning or to convey the flash to the magazine.

The nett result is the same in all cases—the shell does not burst.

Blinds in fuzes may be due to any one of a large number of causes, or even to a combination of two or more causes. Some of the main reasons for blinds in fuzes are as follows:—

- I. Omission to remove safety pin.
- II. Failure of the mechanism to "arm" when discharged from the gun.
- III. A blunt or broken needle.
- IV. Weak flash or weak disruption of the detonator.
- V. Failure of the detonator due to deterioration, multiplication of the covering discs, or other cause.
- VI. Empty or only partially filled magazine.
- VII. Insufficient check given to shell on impact, to enable the graze pellet to overcome the strength of creep spring.
- VIII. Failure to set a time fuze, *i.e.*, the fuze is fired set "on the bridge" (in the safety position).
- IX. Failure of time rings to continue burning.

The term "premature" applied to a fuze indicates that some portion of the fuze has functioned at an earlier period than is intended, resulting in the shell filling being exploded prematurely. "Prematures" may occur owing to faults in the shell itself or its filling and apart from the behaviour of the fuze.

Owing to safety arrangements embodied in some fuzes, a premature action of the fuzed detonator will not always result in a premature explosion of the shell. In some fuzes, however, where there is nothing to prevent the flash from the detonator reaching the magazine, the premature action of the detonator will result in the immediate explosion of the shell.

A premature ignition of a fuze detonator very often results in a shell bursting when the gun is fired and before the shell has had time to reach the muzzle.

A similar accident may occur due to a defective shell or filling.

Therefore, when reporting prematures great care should be taken to ensure that full particulars both of the shell and fuze and the charge used in the gun are reported to the Admiralty, in order to enable the matter to be fully investigated, and to avoid suspicion being thrown on the fuzes, or on the shells, when the other is really responsible for the accident.

Some of the main causes of premature shell explosion attributable to the fuze are as follows:—

- I. The premature functioning of a detonator, due to oversensitiveness, on shock of discharge.
- II. Incorrect assembly or omission of the safety arrangement of the fuze.
- III. A "flash over" of the time rings of time fuzes, due to incorrect assembly or loose tensioning.
- IV. Omission of a creep spring (this may result in premature explosion of the shell during flight).

Prematures have occurred due to numerous other causes than those mentioned above, and it is impossible without thorough investigation to determine the cause of any one accidental explosion.

Detonators for Fuzes.

The term "detonator" is now somewhat loosely applied.

A true detonator is an article which when fired communicates a "wave" of detonation to a high explosive fuze filling.

It has now become customary, however, to refer to both caps which are filled as true detonators, and caps which are filled with an igniferous composition, as detonators.

In Naval Service fuzes, both true detonators and igniferous detonators are used, and in this Handbook, in order to prevent confusion or misapprehension, fuze detonators will be referred to as "Disruptive Detonators" and "Igniferous Detonators."

Disruptive Detonators.—Disruptive detonators are used in fuzes and gaines which have the magazine filled with high explosive.

The function of these detonators is to communicate a wave of detonation direct to the fuze or gaine filling.

The filling of disruptive detonators consists of a charge of pure fulminate of mercury. When this substance receives a hard, sharp blow, a molecular disruption takes place and a wave of detonation is propagated to the fuze filling.

The necessary blow is given by the pressure and heat evolved from the ignition of some gunpowder placed immediately above the fulminate.

Igniferous Detonators.—Strictly speaking, it is not correct to apply the term "detonator" to those caps which are filled with a mixture of fulminate of mercury, potassium chlorate, and antimony sulphide, usually in the proportion 6.6.4, though in some special igniferous detonators the proportions of the ingredients are slightly different. If filled as above, detonators are usually known as "6.6.4 detonators."

The function of an igniferous detonator is not to propagate a wave of detonation, but by means of a flash to ignite gunpowder.

Igniferous detonators are used in fuzes, therefore, for all purposes other than that of initiating a wave of detonation; their usual function is the ignition of the powder filling of a fuze magazine.

Gaines.

It is sometimes necessary to use powder filled fuzes with high explosive shells, while at the same time it is desired to ensure detonation of the high explosive shell filling.

In such cases a "gaine" must be interposed between the fuze and the shell filling.

A gaine, therefore, may be briefly described as a contrivance which will enable a high explosive shell filling to be detonated even though the fuze used is filled with powder.

Whenever gaines are handled,—for example, in fuzing H.E. shells with time fuzes—they must be treated with the greatest care.

FUZE, PERCUSSION, BASE, HOTCHKISS, MARK IV.

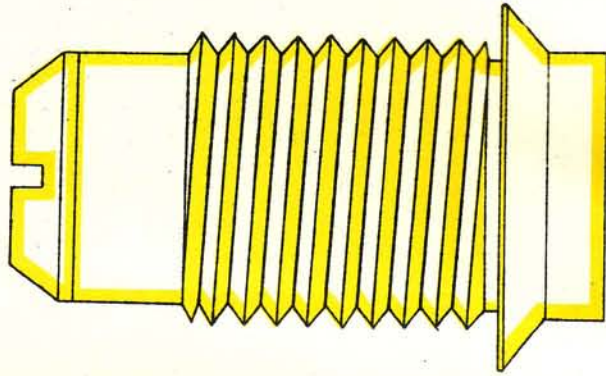

ELEVATION

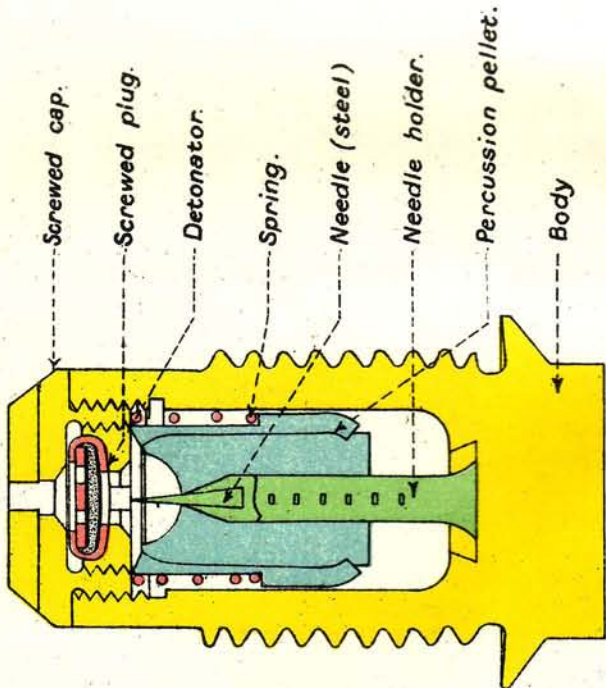

SECTION

PART II.

DETAILED DESCRIPTIONS OF CERTAIN FUZES.

Fuze Percussion Base, Hotchkiss, Mark IV. (Plate 29.)

This fuze is used in 6-pdr. and 3-pdr. steel pointed powder-filled shells, and also in 2-pdr. common pointed shells.

It consists of the following parts:—

Body, percussion pellet, creep spring, screw cap, screw plug, and an igniferous detonator.

The body is made of metal, screwed externally with a left-handed screw (12 threads to the inch), and a flange is formed at the base to act as a gas-check. A projection is also formed below the gas-check to take the key by means of which the fuze is screwed into the shell.

The body is bored out from the front for the reception of the percussion pellet, and at the top the body is screwed internally to receive the screwed cap.

At the bottom of the bore in the body an undercut recess is formed.

The percussion pellet consists of a brass casing filled with an alloy of 12 parts of lead and one part of tin. A roughened needle holder of hard brass wire which carries a steel needle at its front end is embedded in the lead alloy in such a position that the point of the needle does not protrude beyond the level of the top of the complete percussion pellet.

The needle holder has an enlarged base and rests in the undercut recess in the body and supports the whole percussion pellet.

The upper portion of the brass casing is reduced in diameter to accommodate the spiral creep spring.

The screw cap is screwed externally to fit into the body, and internally to receive the screw plug which retains the detonator.

A fire hole is bored through the centre of the front end of the cap to allow the flash from the detonator to pass out.

The igniferous detonator contains, enclosed in a copper cap, 2 grains of 6.6.4 composition.

Action of the Fuze.—On shock of discharge the percussion pellet sets back over the needle holder and so causes the needle to project beyond it.

The alloy at the bottom of the pellet cushions against the bottom of the fuze, and a portion of the alloy dovetails into the undercut recess. This forms a weak connection between the pellet and the body and assists in checking premature action due to rebound.

On graze or impact the pellet sets forward, overcoming the connection formed by the dovetailing of alloy into the undercut recess and the pressure exerted by the creep spring. In going forward it carries with it the needle holder, so that the needle pierces the detonator, the flash from which passes through the fireholes in the cap and ignites the filling of the shell.

Note.—A more sensitive type of Hotchkiss base percussion is being introduced to give more certainty of functioning in 2-pdr. shells, and its use will be restricted to shells of this calibre.

Fuze Percussion Base, Medium, No. 12.

Various marks and descriptions of No. 12 fuze will be found in the Service. Marks earlier than VIII are being withdrawn and are obsolescent.

Ordinary No. 12 fuzes are used in common pointed powder-filled shells 4.7-inch and below.

No. 12 Special Fuzes, *i.e.*, fuzes of which the body and cap are manufactured of lead-free metal, and which are fitted with a steel ring instead of a steel protecting plate, are used in semi-armour piercing shells, 4.7-inch and below, which are filled with lyddite.

The letter "D" placed after the numeral of the fuze, *e.g.*, No. 12D, indicates that the fuze is fitted with an additional "Delay" beyond that inherent in the fuze itself.

The letters "W," "F," or "N" after the number of the fuze relate to the nature of the creep spring fitted to the fuze.

The letter "W" indicates that the strength of creep spring fitted is one-half the strength of the creep spring fitted to the fuze as originally designed.

The letter "F" indicates that the strength of the creep spring is one-fifth the strength of the original creep spring.

The letter "N" indicates that no creep spring is fitted.

In the latest mark of No. 12 fuze to be manufactured, *i.e.*, the Mark XI, when creep springs are fitted they are invariably of the "F" type.

Some fuzes No. 12 had about half the external body threads removed so as to enable them to be used in certain special shells. These fuzes are distinguished by the letter "Q" after the numeral.

No. 12 fuzes with original, "W," and "F" creep springs may be found still in use in common pointed powder filled shells, but all No. 12 special fuzes, with the exception of those used in 4.7-inch semi-A.P. shells, are fitted with "F" creep springs.

The special fuzes issued for use in 4.7-inch semi-A.P. shells are of the "N" type, *i.e.*, the creep spring has been omitted.

It was found necessary to do this in order to attain the requisite degree of sensitiveness to ensure correct action of the fuzes in 4.7-inch shells, when fired against thin plating.

It was found by trial that, on account of the eccentricity of the centre of gravity of the graze pellet in No. 12 fuze, sufficient

FUZE, PERCUSSION, BASE, MEDIUM, No 12, (MARK XI), METAL.

C.P. SHELLS 4.7" AND BELOW.
 "SPECIAL" FUZES—SEMI—A.P. SHELLS
 4.7" AND BELOW.
 No 12 N FOR 4.7" S.A.P. ONLY.

SPECIAL Fuzes are fitted
 with a steel ring in place
 of the steel protecting plug.
 When a creep spring is used
 the number of the fuze is
 No 12 F, Mark XI.
 When the creep spring is
 omitted the number of the
 fuze is No 12 N, Mark XI.

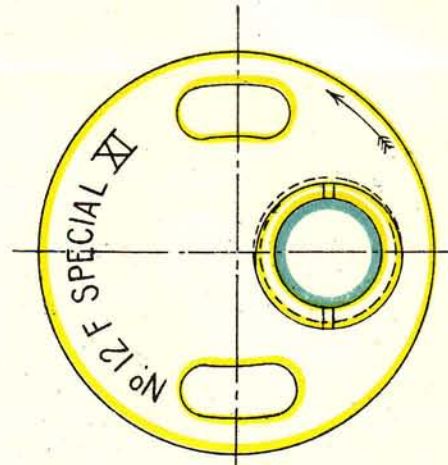
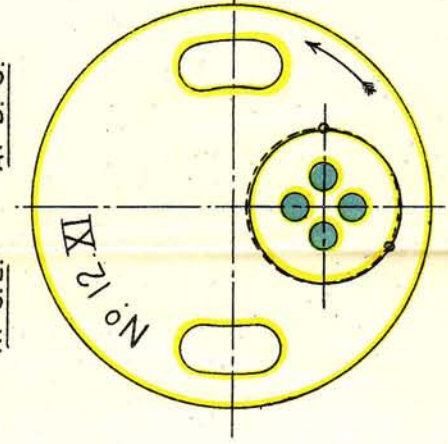
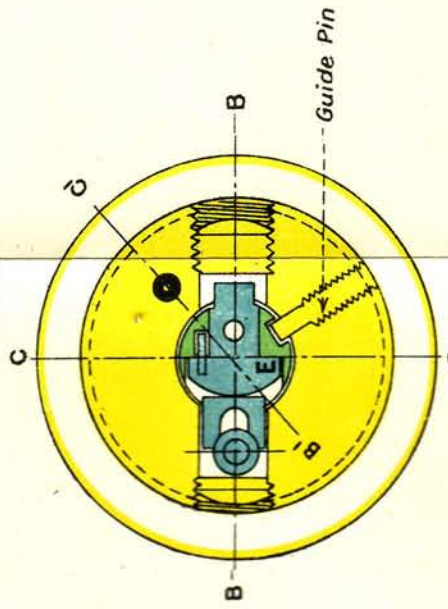
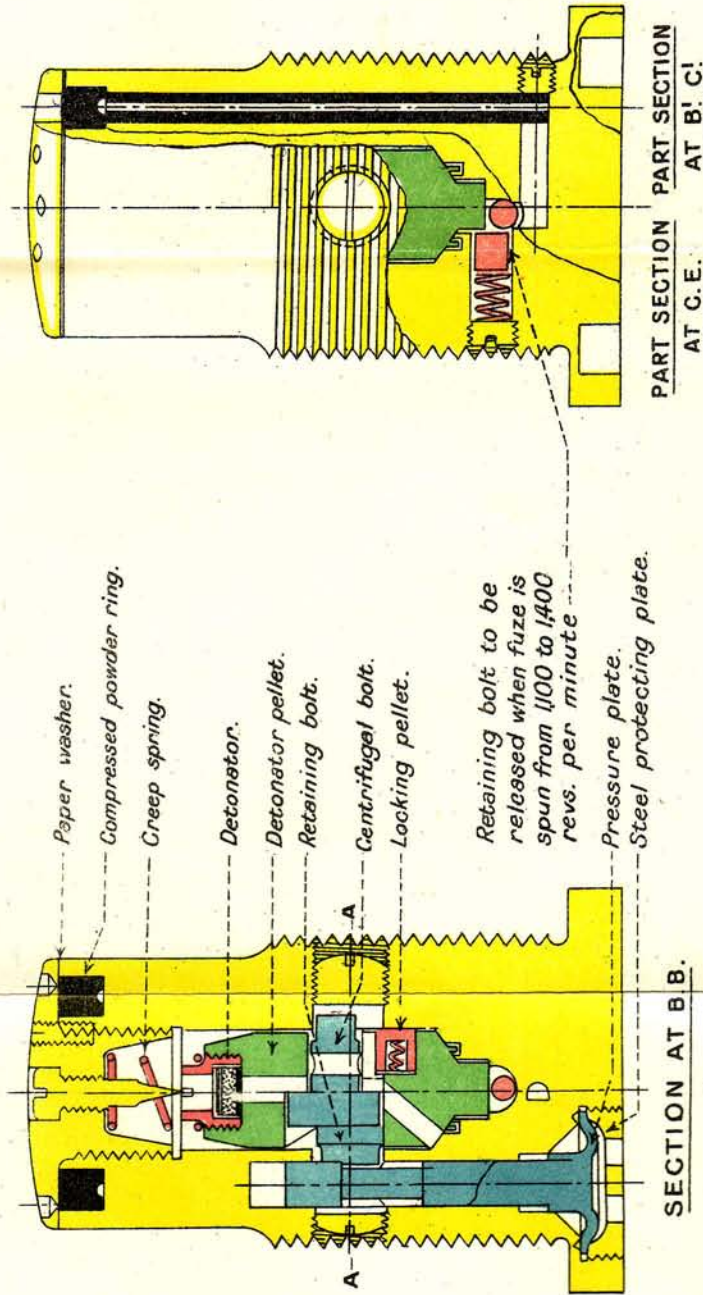

friction was set up to prevent creep action taking place during flight in these shells.

Generally, however, the omission of a creep spring is most undesirable, and resource would only be had to such an expedient when the additional risk involved is considered justifiable on account of war exigencies.

Fuze Percussion Base, Medium, No. 12, Mark XI. (Plate 30.)

The principal components of the fuze are :—

Body, pressure plate and spindle, steel protecting plate, detonator pellet, centrifugal bolt, small retaining bolt, locking pellet with spiral spring, detonator plug with igniferous detonator, brass ball with retaining bolt and spring, creep spring, screwed cap with needle.

The body is made of metal, a flange being formed at the lower end. A portion of the body is screw-threaded externally with a left-handed screw (12 threads per inch). The threading extends for about $1\frac{1}{2}$ inches from the top of the flange.

The body is bored out centrally to receive the percussion arrangement and is screw-threaded internally at the top to take the screwcap.

The percussion chamber is coned towards the bottom and terminates in a small seating for the brass ball.

A flash channel is bored radially through the body and forms a communication between the underside of the ball seating and the bottom of a vertical channel which is bored in the body to one side of the bore for the percussion pellet.

The upper end of this vertical channel emerges into a circular groove formed in the top face of the body.

The vertical channel is filled with perforated powder pellets and the circular groove at the top of the body contains a ring of compressed powder.

On another diameter, and slightly above the flash channel mentioned above, is drilled a second radial hole which contains a small bolt and spring, the function of which is to retain the brass ball (commonly referred to as the pea ball) on its seating until after the fuze is fired in a shell from a gun.

Another vertical bore is made in the body to one side of the central bore, and in this bore the pressure plate spindle works. The lower part of the bore is enlarged to form a seating for the gas-check pressure plate and below the seating the hole is screwed (left-handed) for the reception of the steel protecting plate.

Two key slots are provided in the base of the fuze, to take the key for screwing the fuze into the shell.

The detonator pellet is made of metal and is cylindrical in shape, but the lower part is coned to fit the bottom of the central bore in the body of the fuze.

A circular flange is formed near the bottom of the pellet, and this fits into a circular groove, especially prepared for it, in the body.

The pellet is screw-threaded internally at the top for the reception of the metal detonator plug. A flash hole is drilled vertically from the detonator chamber for about two-thirds of the total length of the pellet, when its direction is changed to enable the flash from the detonator to emerge just above the circular flange on the pellet.

Holes are also bored in the pellet in which the centrifugal bolt and locking pellet are accommodated. The necessary holes to permit of the free action of the components and also the small retaining bolt are suitably bored in the body of the fuze.

A longitudinal groove is formed in the side of the detonator pellet into which fits a small guide pin screwed in through the body. The function of this pin and groove is to prevent the pellet turning in the body.

The centrifugal bolt passes through the detonator pellet at right angles to its axis. One end of the bolt is enlarged and the other end projects, in the position of rest, through the detonator pellet into a recess in the fuze body, so locking the pellet to the fuze.

In this position, the bolt closes the passage through which the flash of the detonator must pass to ignite the fuze filling.

A hole, however, is bored through the shank of the centrifugal bolt in such a position that, when the fuze rotates and centrifugal action causes the bolt to become unlocked from the fuze body, this hole is in prolongation of the flash hole bored in the detonator pellet.

The head of the centrifugal bolt is fitted with a small pin, which enters into a hole in the detonator pellet, and this prevents the centrifugal bolt from turning and ensures that when the bolt moves outward the hole bored through the shank is correctly placed in relation to the flash hole in the detonator pellet.

The small retaining bolt is situated between the pressure plate spindle and the centrifugal bolt, and until the pressure plate is forced forward this small retaining bolt is unable to move outwards, and therefore prevents the centrifugal bolt from becoming unlocked from the body of the fuze.

When the gun is fired and the pressure plate spindle forced forward, that portion of the spindle which is reduced in diameter is brought opposite the small retaining bolt, thus leaving it free to move outward.

This it does under the action of centrifugal force assisted by the pressure exerted on it by the head of the centrifugal bolt.

The igniferous detonator consists of 3 grains of 6.6.4 composition enclosed in a copper cap and covered both top and bottom with a brass disc.

On the top of the upper brass disc is placed a copper washer and the lower portion of the detonator shell is pierced with 4 holes through which the flash of the composition passes when the detonator is fired.

A steel spiral spring rests on top of the pellet and is compressed between the pellet and the underside of the cap of the fuze.

The pressure plate and spindle are made of copper in one piece. At the lower end the plate is formed to fit into the seating in the body specially prepared for it, and in conjunction with which it forms a gas tight joint on firing of the gun, and with which it normally forms a watertight joint.

The pressure plate spindle is cylindrical in shape and extends for about 1.6 inches into the fuze. Near its upper end, it is reduced in diameter to enable the small retaining bolt to move outwards, when the whole pressure plate and spindle are forced forward by the pressure of the gases generated when the gun is fired.

Towards the lower end, the spindle is enlarged in diameter and a boss is formed which prevents the whole component being forced too far forward on firing, and which also forms an additional safeguard against the entry of hot gases.

In the position of rest, the portion of the spindle above the point where the spindle is reduced in diameter bears against the small retaining bolt, and this in its turn bears against the head of the centrifugal bolt, causing the other end of the centrifugal bolt to protrude into a recess in the body of the fuze and so lock the pellet and prevent forward movement.

The shank of the centrifugal bolt when in the position just described also performs the function of blocking the flash hole in the pellet and so prevents a premature ignition of the fuze filling should the detonator be accidentally fired.

The pressure plate is retained in position by a steel protecting plate, which is screwed in left-handed on to its underside. This protecting plate performs the function of protecting the copper pressure plate from accidental blows, such as might force the pressure plate and spindle forward, causing the small retaining bolt to leave its position of safety and permit of the centrifugal bolt becoming unlocked from the body of the fuze, thus rendering the detonator pellet liable to move forward, only the action of the creep spring preventing this taking place.

Four holes are bored through the steel protecting plate to permit of pressure from the gases generated on firing the gun being exerted on the base of the pressure plate.

The cap is made of metal and is screwed externally for attachment to the body.

A steel needle is screwed in through the centre of the cap from the top, and six holes are bored in the cap to allow the flash from the fuze filling, when fired, to pass into the shell. A paper washer is secured with shellac to the under side of the cap, and a fillet of Pettman cement is inserted into each flash hole.

A seating for the upper end of the creep spring is formed on the underside of the cap and the cap is prevented from unscrewing by means of a set screw which passes vertically through it into the body of the fuze.

Action of the fuze.

I. **Safety Arrangements.**—The fuze is specially designed to withstand considerable rough usage without being rendered dangerous or unserviceable, and also to prevent accidental ignition of the fuze filling (and so a premature explosion of the shell) should the fuze detonator fire accidentally before the fuze is "armed."

The centrifugal bolt in the detonator pellet performs a double function, since its strong shank which protrudes from the detonator pellet into a specially prepared recess in the body securely locks the whole percussion pellet in its rearmost position, and also blocks the detonator flash channel in the detonator pellet, until such time as the bolt becomes unlocked from the body of the fuze.

Thus, the detonator is unable to reach the needle, and should the detonator fire accidentally, due to rough usage or shock, the flash should not pass beyond the centrifugal bolt.

There is, however, always a possibility that, owing to human shortcomings, faults may occur either in manufacture or in assembly, which might result in the flash from a prematurely fired detonator being able to pass beyond the position at which it should be normally stopped by the centrifugal bolt.

For example: the small retaining bolt may be inadvertently omitted. This would mean that the centrifugal bolt would be able to pass across the detonator pellet so that the hole in the shank of the bolt was placed in prolongation of the flash hole in the detonator pellet at any time.

To guard against the possibility of accident due to the flash of a prematurely fired detonator passing the point where it should be stopped by the centrifugal bolt, additional safety arrangements against premature ignition of the fuze filling are embodied.

Firstly, the flash from the detonator on emerging from the lower portion of the flash channel in the detonator pellet is blocked by the small flange formed on the conical portion of the detonator pellet; and secondly, should the flash manage to get past this flange, it is blocked by the pea ball covering the entrance to the flash channel in the base of the fuze.

Thus, unless the detonator pellet is raised off its seating, the fuze is particularly safe against accidental ignition of its filling, in the event of the detonator firing prematurely either at rest or when the gun is first fired and before the shell leaves the muzzle.

That component known as the small retaining bolt may, if it is possible to differentiate between any component constituting one of the safety arrangements of a fuze, be regarded as the most important of all, since if it is omitted the centrifugal bolt can move across the detonator pellet, and not only open up a free passage for the flash of the detonator through the pellet, but also unlock the pellet from the body of the fuze, thus leaving the former free to move forward off its seating and so destroying the efficacy of the other safety arrangements.

As this small retaining bolt is a small component it is by no means difficult for it to be dropped out during the assembly of a fuze, and special tests are therefore carried out to ensure that no fuze is issued to the Service in which it is absent.

II. Action on firing of gun and on impact with target.—

The pressure of the gases generated by the charge on firing of the gun is exerted, through the four holes in the steel protecting plate, on the base of the copper pressure plate.

The whole pressure plate and spindle are forced forward, the spindle being prevented from going too far forward by the boss formed at its lower end coming into contact with the seating specially prepared for it in the body of the fuze.

In moving forward the portion of the pressure plate spindle, which is reduced in diameter, is brought opposite the small retaining bolt, and the latter is therefore free to move outward.

Under the action of centrifugal forces, resulting from the rotation of the shell, both the small retaining bolt and the centrifugal bolt move across the fuze, and the detonator pellet becomes unlocked from the body of the fuze.

At the same time the detonator flash channel becomes unblocked owing to the hole in the shank of the centrifugal bolt being brought in line with the hole in the pellet.

By the action of centrifugal force, also, the small bolt, which retains the pea ball in position, moves outward against its spring, thus enabling the pea ball to move off its seating into the position originally occupied by the bolt. (The pea ball seating is made slightly eccentric in order to ensure the pea ball moving into the retaining bolt recess.)

The creep spring assists to prevent rebound action of the percussion pellet, should the latter become unlocked from the fuze before the shell leaves the muzzle.

It is, however, improbable that the centrifugal forces set up are strong enough to cause the small retaining bolt and centrifugal bolt to move outwards before the shell leaves the gun, on account of the friction set up by setback forces.

During flight the detonator pellet is prevented from moving forward relatively to the shell by the creep spring, and it is prevented from turning in the fuze body by the guide pin, which fits into the groove formed on the pellet itself.

Apart from the prevention of any tendency of the pellet to screw itself forward during flight, it is essential in this fuze, and in other fuzes of the same type, that the pellet should be prevented from turning, since otherwise the locking pellet might be unable to function.

On the forward velocity of the shell being checked by graze or impact the percussion pellet moves forward, overcoming the resistance of the creep spring, and carries the detonator on to the needle. The forward movement of the pellet also disengages the flange formed at its rear end from the seating into which it

fits in the body, thus opening up a clear passage for the detonator flash through the hole originally closed by the pea ball into the lower flash channel, which communicates with the bottom of the vertical powder pellets.

When the percussion pellet has moved forward a certain distance, the locking pellet is forced outward by its spring into the same recess that was originally occupied by the small end of the centrifugal bolt.

This locking pellet prevents the percussion pellet moving to the rear again under the action of the creep spring, so closing the passage for the detonator flash.

The detonator is fired by the needle and its flash passes through the flash channels in the pellet and centrifugal bolt, through the hole originally closed by the pea ball, and into the flash channel at the base of the fuze, and ignites the perforated powder pellets in the vertical channel.

These burn and ignite the powder ring at the top of the fuze, the flash from which passes through the holes in the cap of the fuze and ignites the filling of the shell.

A slight "delay" is inherent in the fuze owing to the time taken for the pellet to move forward on to the needle for the detonator flash to ignite the fuze filling, and for the burning of the fuze filling itself.

Fuze Percussion Base, Large, No. 16, Mark IV.

This fuze is similar in construction to No. 12, Mark XI, but is made on a larger scale.

The body is manufactured of a special alloy, and both the body and the cap are made of "lead free" material, so as to enable the fuzes to be used in shells filled with high explosive of which picric forms an ingredient.

The copper pressure plate is retained in position by a steel protecting ring (as in the case of No. 12 special fuzes) instead of being covered by a steel protecting plate.

The cap is screwed for a longer distance and with a coarser thread than in the case of No. 15 fuze, so as to form a stronger connection between the cap and the body.

The interior of the cap is coned to receive the front end of the detonator pellet, which is tapered.

The object of the coning of the cap and the tapering of the front end of the detonator pellet is to cushion the blow of the detonator pellet on the cap when the forward motion of the fuze is checked, and so reduce the liability of the cap to be forced out of its seating, when the shell in which the fuze is fired receives a violent check on impact with heavy armour.

NOTE.—"Delay" or "D" fuzes can be easily identified by the colour marking of the base and cap of the fuzes.

FUZE, TIME AND PERCUSSION, N° 92, MARK II.

FULL SIZE.

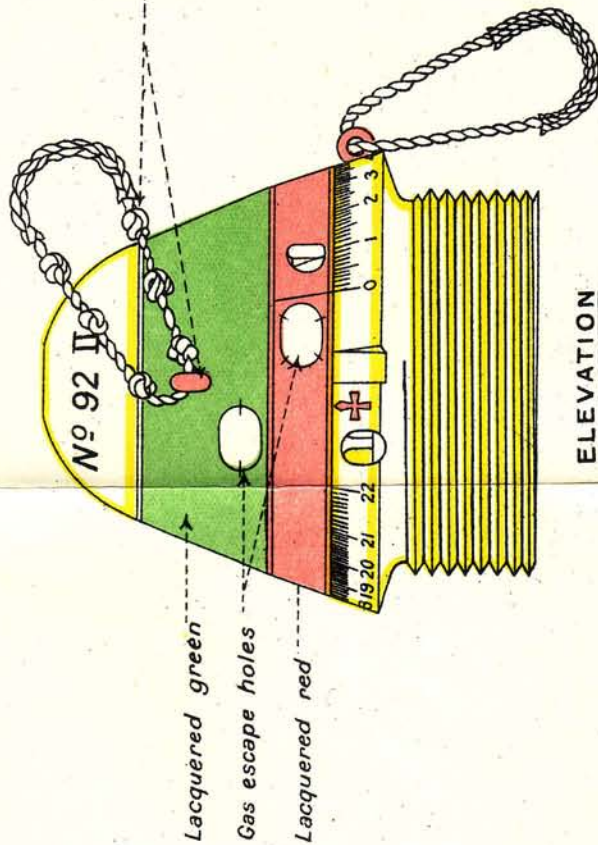

ELEVATION
FUZE SET AT "0".

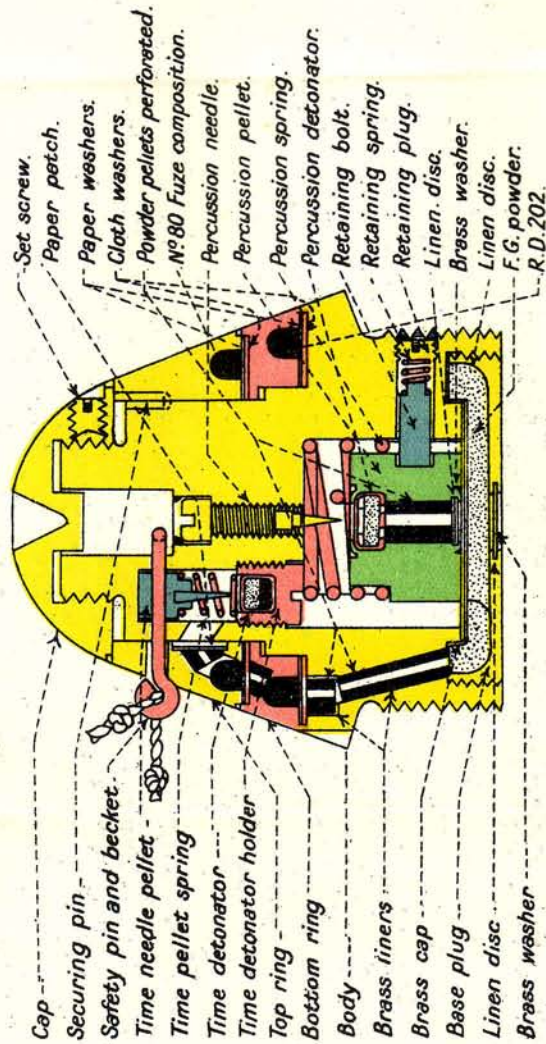
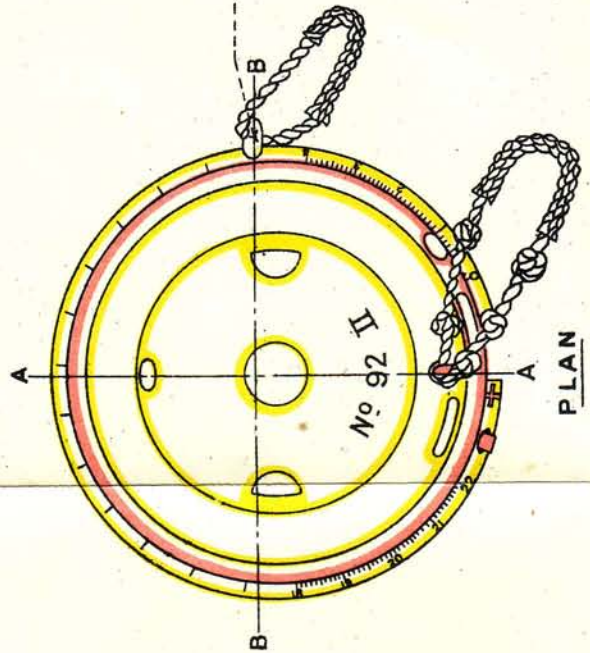

SECTION AT A.A.

FUZE T. & P. N° 84 MARK II.
N° 84 mark II fuze differs from the
N° 92 mark II in having the top and
bottom rings filled with N° 83 fuze
composition.

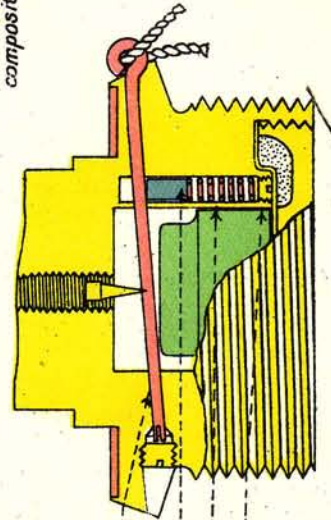

PART SECTION AT B.B.

No. 16D fuzes are marked on the base thus :—

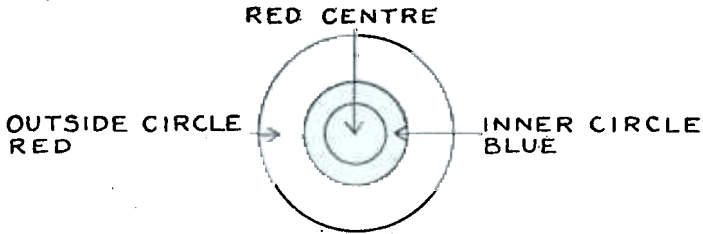

All No. 16 and No. 16D fuzes are only used in shells which are fitted with base cover plates, and the fuzes themselves are covered by a copper gas-check which is placed between the fuze and the base cover plate.

(Refer to plate showing A.P.C. shell.)

Time, and Time and Percussion Fuzes.

Fuze, Time and Percussion, No. 81 Mark II.

This fuze is now only used in star shells.

It is similar in all respects to fuze No. 93 Mark I, except that the time rings are filled with 30-sec. fuze powder.

Fuze, Time, No. 181.

This is No. 81 T. and P. fuze Mark II, with the percussion arrangement removed. It is used with star shells.

Fuze, Time and Percussion, No. 84.

These fuzes were originally issued for use in shrapnel shells 7·5-inch and below, but have now been superseded by No. 93 fuze for 7·5 inch and 6-inch, and by No. 192 for 5·5-inch and below.

No. 84 fuzes are rapidly being withdrawn from the Service, and after withdrawal will be converted to No. 192, which fuze is similar in all respects to No. 84, but has the percussion mechanism omitted and the time rings filled with compositions, which result in long times of burning being obtained if desired.

Fuze, Time and Percussion, No. 92 Mark II. (Plate 31.)

Fuze, Time, No. 192 Mark I.

These two fuzes differ only in that the former is fitted with a percussion mechanism, while the latter has the percussion mechanism removed, the space occupied by it being filled with a wood plug.

No. 92 fuzes were originally approved for use in shrapnel shells 5·5-inch and below, where such shells are screwed to the 2-inch fuze hole gauge.

No. 192 fuzes were approved for use in 4-inch H.E. shells in conjunction with No. 8 gauge.

It has, however, been found that the type of percussion mechanism fitted to No. 92 fuzes is not so safe and reliable against

the possibility of premature action as is desirable in Naval Service fuzes, so that all future fuzes of this type will have the percussion mechanisms omitted and become time fuzes only under the nomenclature No. 192.

Any No. 92 fuzes already issued to the Service will gradually be withdrawn for conversion to No. 192 by removal of the percussion mechanism.

Both No. 92 and No. 192 fuzes are "tensioned" fuzes, the cap being screwed down so that the bottom ring turns under a moment of 144 ± 12 in./oz.

The fuzes are provided with setting studs, one in the body and one in the bottom ring to enable them to be used with a fuze setter.

No. 92 fuzes consist of the following principal parts:—Body and top cap of aluminium alloy, two metal time rings, metal base plug, a percussion needle plug and time needle pellet, a time detonator holder with igniferous detonator, a metal percussion pellet carrying an igniferous detonator and a perforated powder pellet, 3 metal centrifugal bolts, metal tube liners, and the necessary springs, guide pins, setting pins, &c. Two safety pins are also provided which have beackets attached to them, that for the time safety pin being knotted at $\frac{1}{2}$ -inch intervals to enable it to be easily identified by touch.

The lower part of the body is screwed externally to the 2-inch fuze hole gauge, and internally for the reception of the base plug.

Above the external screw threading the body is enlarged and a seating is formed on the underside to fit the shell into which the fuze screws, and on the upper side a platform is formed on which the bottom time ring rests.

Above the platform the body terminates in a stem, the upper part of which is threaded to receive the cap.

The body is bored and screwed internally to form the magazine and to receive the percussion mechanism and base plug. Two screwed holes are formed to receive the percussion needle plug and the time detonator pellet.

Above the latter, the hole is continued to receive the time needle pellet and spring.

Holes as necessary are formed in the body to receive the centrifugal bolts retaining the percussion pellet and the safety pin, and to permit the flash from the detonator to reach the upper time ring.

A small hole is also bored vertically to receive the percussion safety pin, closing plug and spring, and the top of the stem of the body is recessed out.

Holes are also bored in the body to receive the perforated powder pellets, which convey the flash from the bottom ring to the magazine.

The outside of the platform of the body is graduated from 0 to 22, the graduations being subdivided into tenths. A safety mark is also provided, and a steel setting stud is screwed into the body to enable the fuzes to be used with a fuze setter.

The top cap is screwed and shaped internally to fit the top of the stem of the body. It is provided with a set screw to enable it to be clamped in the correct position after the tensioning of the time rings has been adjusted.

The metal time rings are provided with channels, that in the top ring being filled with 22-sec. powder, and that in the lower ring with R.D. 202 composition.

Washers of vegetable paper are shellaced to the bottom surface of each ring after the powder has been pressed in position.

A hole is bored at an angle from the top of the bottom ring to the commencement of the composition, and in this hole a perforated powder pellet is placed to assist the ignition of the fuze powder.

Holes are also bored to form a communication between the commencement of the powder in the top ring to the interior of the ring, the inner opening of the interior hole being positioned so as to be opposite the flash hole bored in the stem of the body.

A perforated powder pellet is placed in the interior hole in the top ring to assist in the flash from the detonator being conveyed to the powder; the hole, in which this pellet of powder is placed, is closed by a paper patch secured with shellac.

In each ring fire escape holes are provided so that the gases formed by the combustion of the fuze powders can escape into the atmosphere, and perforated pellets of powder are inserted into each of these to ensure that the brass discs, with which these holes are closed, are blown out when the fuze powder ignites.

The rings fit over the stem of the body, cloth washers being secured to the platform of the body and the top of the bottom ring with shellac varnish, holes being provided in the washers to expose the powder pellets in the body and top of the bottom ring respectively.

The percussion needle holder, which carries a steel needle, is screwed into the centre of the bore in the base of the body in the Mark I fuze. The Mark II fuze has a "screwed needle" which screws into the body from the top.

The time needle pellet and spring are inserted in the bore made to receive them, and are retained in position by the time detonator holder, which, with the detonator, is screwed into the bottom of that recess.

The percussion pellet has a seating formed in the top for the percussion detonator, and a hole is bored through it centrally to receive a perforated powder pellet, which is retained in position by a linen disc and brass washer.

Three circular recesses are bored in the pellet to receive the retaining bolts, and a perpendicular slot is also made in which the guide pin works and prevents the pellet turning.

The creep spring is situated between the percussion pellet and the top of the bore in the body, and the whole of the percussion mechanism is covered with a linen disc.

The brass washer, which has a hole bored in it, so that the flash from the perforated pellets in the body can pass into the

magazine, is secured in position by the base plug and the magazine is filled with F.G. powder.

Holes are drilled through the top ring, stem of the body and time needle pellet, through which passes the time safety pin.

Another hole is drilled through the lower portion of the body for the percussion safety pin.

Action of the Fuze.

I. Safety Arrangement.—The time needle pellet is prevented from compressing its spring prematurely and approaching the detonator by the time safety pin, which holds it in its uppermost position.

Should, however, the time detonator function prematurely and ignite the time composition, the flash is prevented from reaching the magazine by the fuze being set to "safe," in which position a solid portion of the bottom ring is above the flash hole in the body.

The percussion pellet is prevented from moving forward by the percussion safety pin which, passing across the top of the pellet, holds it in the rearmost position.

After the percussion safety pin has been removed, the pellet is still retained in its rearmost position by the three centrifugal bolts.

II. Action on Firing.

(a) **Time Portion.**—Immediately before firing the time safety pin is removed, and the lower ring set in the desired position.

When the gun fires, the time needle pellet sets back and, overcoming the resistance of the spring, fires the igniferous detonator.

The flash from the detonator passes through the hole drilled in the stem of the body, ignites the pellet in the top ring, which in its turn ignites the fuze powder.

The powder in the top ring then burns round in the same way as the shell is rotating until it arrives at the perforated pellet at the beginning of the lower ring. The powder in the lower ring then ignites and burns round in the opposite direction until it arrives at the perforated pellet in the body, which it ignites, causing the magazine to explode.

The flash and gases from the magazine enter the shell and either fire the gaine below it or ignite directly the shell burster, according as whether the fuze is used in H.E. or shrapnel shells.

(b) **Percussion Portion.**—The percussion pin is removed, and the hole through which it passes is closed by the closing plug, which moves forward under the action of its spring.

The percussion pellet is then prevented from moving forward by the creep spring and the three centrifugal bolts.

When the shell is fired from the gun, the rotation causes the three centrifugal bolts to become disengaged, so that the pellet is then only held back by the creep spring, while the guide pin prevents the pellet from turning. On graze or impact the forward

FUZE, TIME, NO 185, MARK I.

**H.E. SHELLS 3" (12 1/2 LBS.)
SHRAPNEL SHELLS 3" AND 12 PR 18 CWT.
TARGET SMOKE SHELLS 3"**

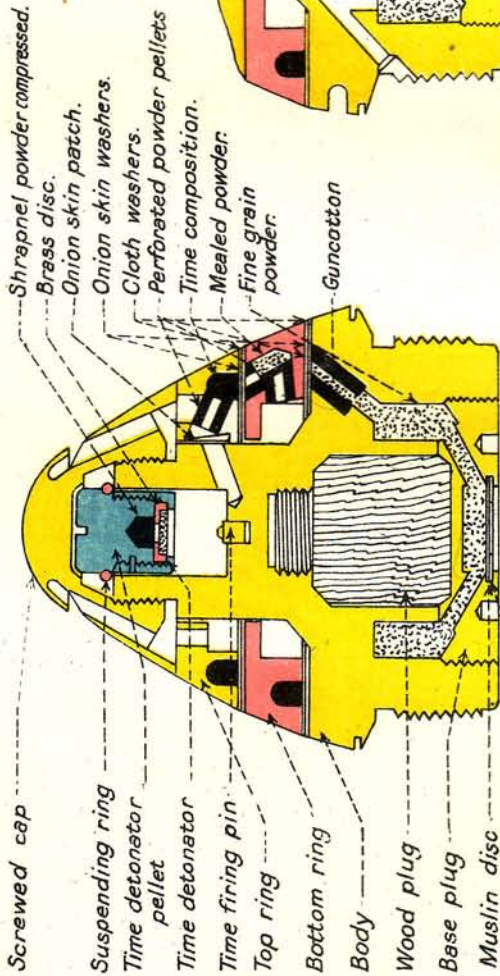

SECTION OF EMPTY FUZES.

SECTION OF FILLED FUZES.

velocity of the shell is checked, and the pellet moves forward, overcoming the resistance of the creep spring, the needle pierces the igniferous detonator, and ignites the powder pellet below it, the flash from which passes into and explodes the magazine.

Both No. 92 and No. 192 fuzes, which are similar in appearance to No. 84 fuzes, have the top ring lacquered green (indicating 22-sec. fuze powder), and the bottom red (indicating R.D. 202' composition), so that they can easily be distinguished from No. 84 fuzes. In addition the No. 192 fuze, which is a time fuze only, has a large letter "T" stencilled on it in blue.

Fuze, Time, No. 185, Mark I. (Plate 32.)

A stock of these fuzes were obtained from the United States of America during the recent war, and the fuzes are used in 3-inch (12½-lb.) H.E. shells, in 3-inch shrapnel shells, and in 3-inch target smoke shells.

The fuzes were originally obtained on account of trials showing that, when fired from 3-inch high angle guns, the percentage of blinds obtained were very much less than occurred when any available British time fuze was used under the same conditions.

A fuze consists principally of a body of metal which terminates in a stem, and which is screwed externally at the lower end to the 2-inch fuze hole gauge. The interior is bored out, and that portion of the bore, which would normally receive the percussion mechanism, is filled with a wooden plug. A platform is formed for the lower time ring to rest on, and the two time rings are placed over the stem of the fuze, and held in position by the metal cap.

Fuzes are of the "tensioned" type so that the cap, which is fitted with a set screw, can be fixed in position after it has been screwed down to the required degree, which is that the bottom time ring can turn under a moment of 325 in./oz.

A recess is formed in the top of the stem in which works the time detonator pellet. The pellet is suspended by a ring which is sprung into a groove in the pellet itself, and which rests on top of the stem.

The cap is of a special type to enable the gases formed, when the fuze powder burns, to escape through the nose of the fuze, and the time rings are specially manufactured so that the gases are led to the interior of the fuze instead of directly into the air, as is the case in ordinary British time fuzes. (The British No. 069 fuze is based on No. 185 fuze.)

The bottom ring of the fuze carries graduations from 0 to 21, each of which is subdivided into 5 smaller divisions.

A safety mark is also placed on the bottom ring and the setting mark is placed on the body.

Studs are provided, one in the body and one in the bottom ring, to enable the fuze to be set by means of a setter.

No safety arrangements are embodied in the fuze beyond the "bridge" setting position and the spring ring suspending the time pellet.

When the gun is fired the time pellet sets back through the suspending ring, which opens out, and the detonator is fired by being forced on to the firing pin. The flash from the detonator ignites the upper time ring and the subsequent action of the fuze is similar to that of ordinary British double ringed time fuzes.

As soon as existing stocks of No. 185 fuzes have been used up the fuze will become obsolete.

Fuze, Hydrostatic Valve, No. 8, Mark I. (Plate 33.)

This fuze is used in anti-submarine bombs and is screwed into the side of the bomb.

Four different types of fuzes are in use, but they differ only from each other in respect of the strength of the spring which governs the depth at which the fuze fires.

H.V. fuzes No. 8, fitted with the spring to cause them to function at a depth of 40 feet, are known as No. 8 fuzes. Those fitted with springs to function at a depth of 90 feet are known as No. 8A fuzes, while those fitted with springs which cause functioning to occur at depths of 140 feet and 190 feet are known as No. 8B and No. 8E respectively.

The fuzes consist of the following principal parts:—Body, cover, pressure plate, plunger, hydrostatic valve spring, metal washer, detonator holder with igniferous detonator, striker and striker spring, tinned plate cup, safety pin with loop, rubber diaphragm and washer, and leather washer.

The body is made of metal and has a square hole accurately made through the centre in which slides the square portion of the plunger spindle. Two holes are bored at right angles to the axis, one of which is screwed to receive the detonator plug, and in the other of which is situated the striker and spring. The lower portion of the body is shaped to accommodate the bag of powder which forms the magazine, and the upper portion has a seating formed of the hydrostatic valve spring. Two vent holes are drilled to form a communication between the upper and lower parts of the body, and these prevent the formation of an unduly strong air cushion.

The steel cover is secured to the body by twelve steel screws, and between the cover and the body is gripped the rubber diaphragm. Four water entry ports are drilled in the cover to admit water to the top of the diaphragm and pressure plate.

To the phosphor bronze plunger is attached the pressure plate and nut, and the upper portion of the plunger passes through the centre of the rubber diaphragm, the latter being gripped between the pressure plate and the nut, a brass washer and a rubber washer being interposed between the diaphragm and the nut to prevent damage to the former.

A safety pin passes through the boss of the cover and a hole in the plunger, and until this is removed, the plunger cannot be forced downwards.

FUZE, HYDROSTATIC, VALVE N° 8, MARK I.

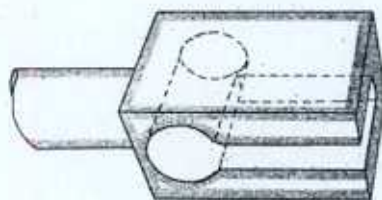
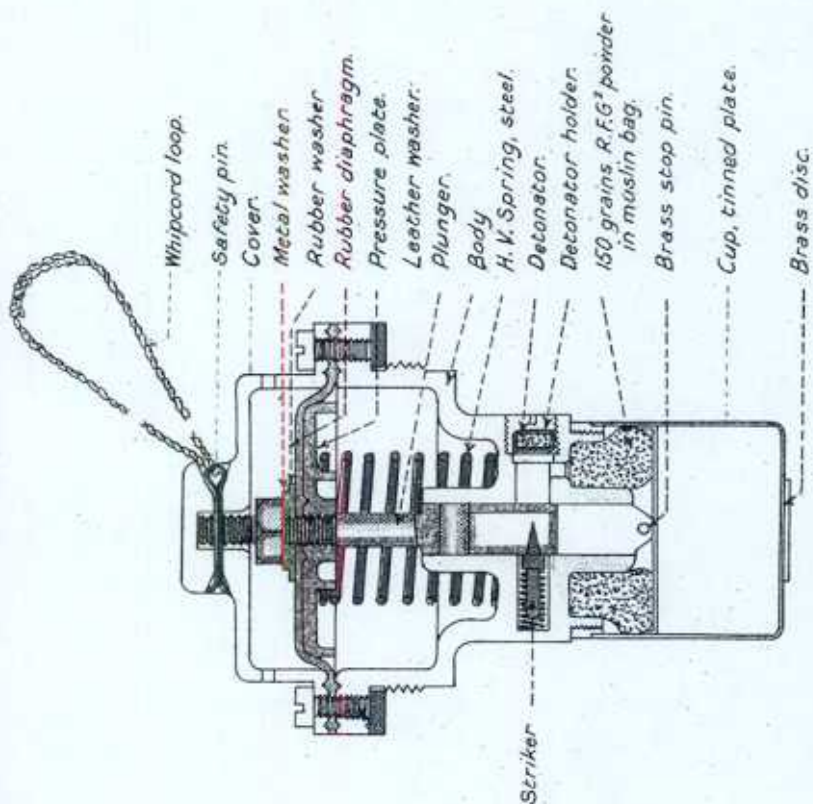

LOWER PART
OF PLUNGER.

FUZE. HYDROSTATIC, VALVE N° 8, MARK I.

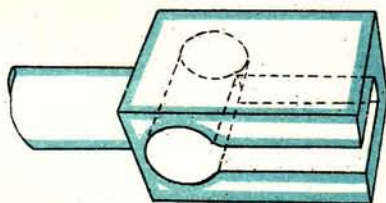
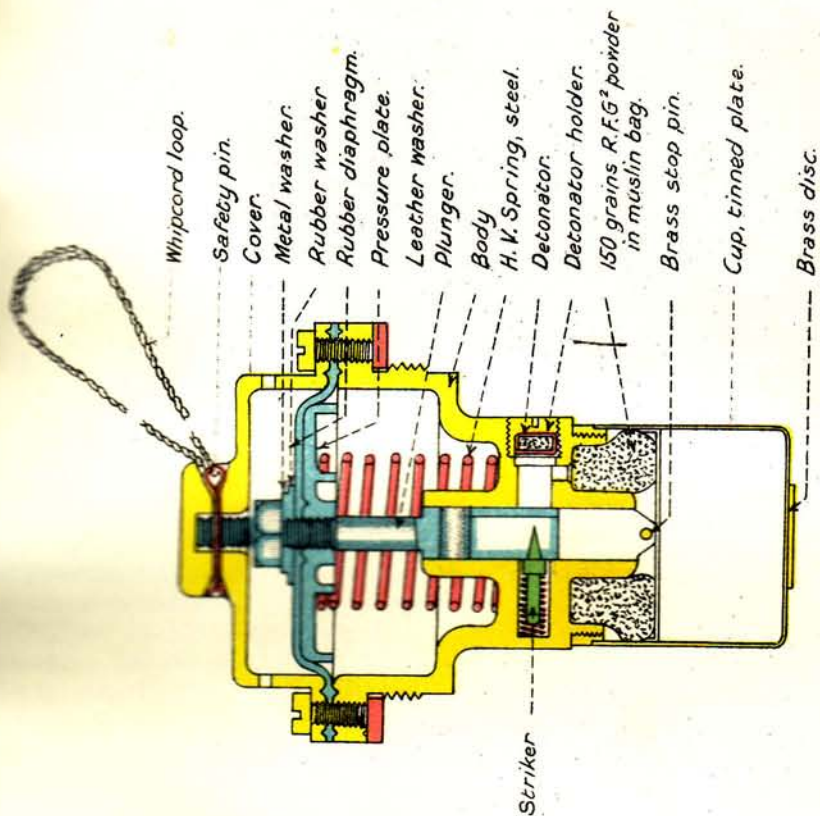

LOWER PART OF PLUNGER.

The tinned plate cup supports the powder charge and screws on to the bottom of the body, and the empty space in the cup itself prevents the formation of an air cushion.

The striker moves in a longitudinal groove in the plunger, at the top of which a hole is bored, through which the striker can move after the plunger has been depressed.

Safety Arrangements.—The only safety arrangement embodied in the fuze is that of the safety pin, and it is most important to ensure that this pin is not removed until immediately before the fuze is required for firing.

When the pin has been removed, a very small drop on the base is sufficient to cause the plunger to become depressed far enough to allow the hole in the plunger to become placed opposite the striker, with the result that a premature explosion occurs.

Action on Firing.—Immediately before firing the safety pin is removed. No action takes place when the bomb thrower is fired, but when the bomb strikes the water, water enters through the entry ports in the cover, and as the bomb sinks and the pressure becomes greater, the diaphragm and pressure plate are forced downwards against the action of the H.V. spring until the hole in the plunger is opposite the striker, which then flies forward and fires the detonator. The detonator ignites the magazine, and the bomb is detonated through the medium of an exploder.

Designs of H.V. fuzes which are adjustable for depth are under trial, but these improved fuzes have not yet been introduced into the Service.

PART III.

GAINES.

Gainé No. 2, Mark III.

This gainé is used with No. 185 fuze in 3-inch target smoke shell.

It consists of a steel body screwed at the top to suit the adapter, into which it fits below the fuze, and at the bottom for the reception of a steel cap.

A large cavity is bored in the centre of the body from the bottom in which are placed the detonator and the C.E. pellets forming the magazine, and these are retained in position by the steel cap, a paper disc being placed between the cap and the bottom of the body.

A somewhat smaller bore is drilled from the top for the reception of perforated powder pellets; the top and bottom bores are connected by a small hole, and the top of the gainé is covered by a paper disc.

When the fuze fires, the powder pellets in the gainé are ignited and the gases formed pass through the small channel connecting the top and bottom bores, and cause disruption of the 10-grain fulminate detonator which initiates detonation of the C.E. pellets in the gainé, these in their turn causing the shell filling to detonate.

Gainé No. 2, Mark II.

This gainé differs from the Mark III gainé in a few minor details and also in being fitted with a slightly different type of fulminate detonator.

Caution.—When it is necessary to handle gainés, the greatest care is necessary to avoid knocking the gainé. Rough usage may cause the detonator in the gainé to explode. If this happens the safety shutter may prevent an explosion of the gainé, but the risk is great of a serious accident.

PART IV.

DETONATORS USED IN NAVAL SERVICE FUZES.

Description of a Typical Igniferous Detonator.

The shell consists of a copper cup which is pressed into shape, and through the base of which four holes are pierced. Lugs are formed at the top of the cupped shell.

A thin brass disc is placed at the bottom of the shell covering the four holes, and on top of the brass disc is placed the charge of detonating composition, which consists of a mixture of :—

Fulminate of mercury	6 parts by weight.
Chlorate of potash	6 parts by weight.
Antimony sulphide	4 parts by weight.

This composition, which is put in dry, is pressed into the detonator under a dead load of 600 lbs. and the surface of the composition is then covered with shellac varnish.

A second brass disc is placed over the varnished composition, and on top of that disc a copper washer rests; the lugs on the shell are turned over on to the copper washer and retain it in position.

Description of a 10-grain Disruptive Detonator.

The shell consists of a copper cup, into which is pressed, under a dead load of 700 lbs., 10 grains of fulminate of mercury, and on top of the fulminate charge is pressed, also under a load of 700 lbs., $4\frac{1}{2}$ grains of gunpowder.

The top surface of the gunpowder is then given a coating of shellac.

General.

Before any detonators are issued for insertion into Naval Service fuses, the greatest care is taken to ensure that they are correctly made, that they are clean, and that no loose fulminate or igniferous composition is present on the exterior of any detonator. But, in spite of all the precautions which are taken, it is quite impossible to ensure that over-sensitive detonators are not sometimes passed into the Service.

It is, therefore, of the utmost importance that detonators or fuzes containing detonators should be very carefully handled in the Service.

Both pure fulminate of mercury and igniferous compositions are liable to deteriorate with time, but the rate of deterioration of igniferous composition is very much less than that of pure fulminate.

While under ordinary Service conditions an igniferous detonator filled with 6.6.4 composition may be expected to retain its efficiency for probably 16 years, a pure fulminate detonator is liable to become quite unserviceable in from 4 to 5 years, and the necessary action to ensure that unserviceable detonators do not remain in fuzes is being considered.

The speed at which any type of detonator deteriorates is, of course, greatly affected by the temperature to which the detonators are subjected, the higher the temperature the shorter the life of the detonator.

1 INCH ELECTRIC AIMING RIFLE CARTRIDGE.

SCALE = 1/4

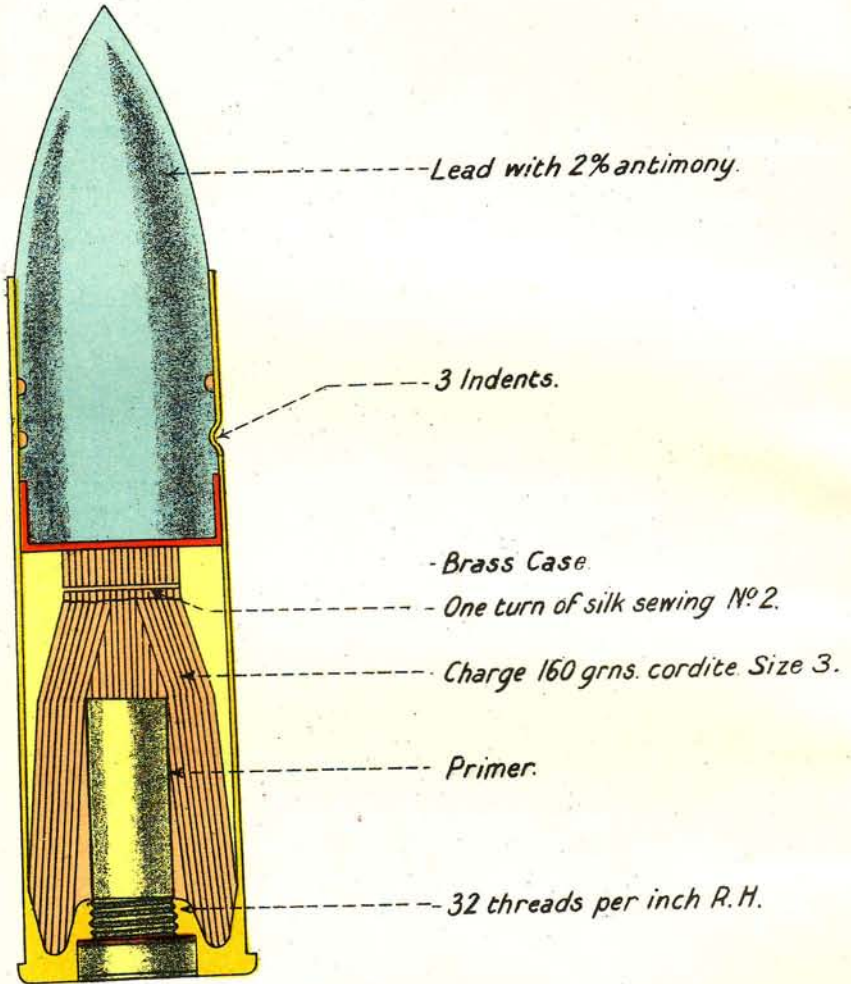

PRIMER.

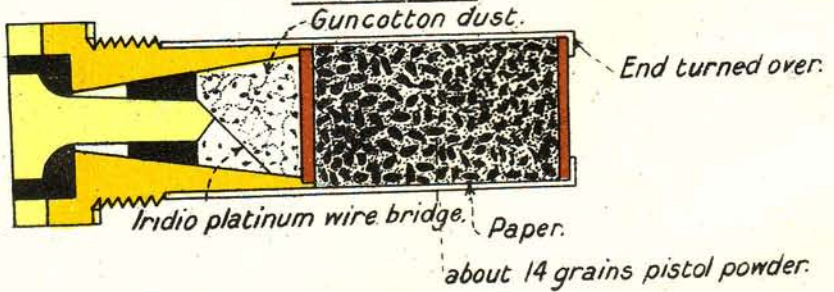

CHAPTER XI.

SMALL ARM AMMUNITION.

The term small arm ammunition generally includes ammunition for aiming rifles in addition to rifle and pistol ammunition.

All such ammunition is fixed and is supplied in small arm ammunition boxes and metal-lined cases.

1-inch Aiming Rifle Ammunition.

This ammunition was originally filled with powder. New ammunition is now made filled with cordite.

It is manufactured either for percussion or for electric firing. Some ammunition is now being made with steel bullets. This is included in the designation.

Electric Aiming. (Cordite, Lead Bullet.) (Plate 34.)—The cartridge consists of a solid drawn brass case, lacquered internally except that part which envelopes the bullet and the threads of the primer hole.

The primer consists of a brass body having an enlarged head; the body is threaded near the head to screw into the case; the head fits into a recess, a fibre washer making a tight joint.

The body is bored out, the metal being thinned at the front end.

Fitted into the body is a brass contact pin, insulated from the body by two ebonite plugs, the front plug being coned to suit the coned seating in the primer.

An iridio-platinum wire bridge, resistance 1 to 1½ ohms, is soldered with pure tin to the front of the contact pin and front edge of the body. Two slots are cut in the head for the key for inserting or removing the primer.

A paper tube is secured outside the plain part of the body by shellac varnish.

The body of the primer is filled with dry guncotton or cotton powder dust, and the mouth is closed by a card disc pressed in.

The paper tube is charged with about 14 grains of pistol powder and closed by a card disc, the end of the tube being turned over and secured with shellac.

The charge consists of about 160 grains of cordite, size 3, cut about 2.4 inches long and tied near the front end by a single tie of silk sewing.

The bullet is made of an alloy composed of 98 parts lead and 2 parts antimony; two cannelures are formed round it and are filled with pure beeswax; the base is reduced in diameter to receive a copper cup.

The cup is made of solid drawn copper and is pressed firmly on and indented. The bullet weighs 10 ozs. with a tolerance of 70 grains.

Percussion Aiming. (Cordite, Lead Bullet.)—The Mark I cartridge differs from the electric in having a percussion cap, above which is an anvil containing a magazine of fine grain powder.

The Mark II cartridge has a .455 pistol cartridge containing about 5 grains of R.F.G.² powder, as the means of ignition.

1-inch aiming rifles firing steel bullets were used during the war for sinking mines.

Small Arm Ammunition.

.303-inch Ball Cartridge, Mark VII. (Plate 35.)—The cartridge consists of a case, percussion cap, charge, glazed board disc and bullet.

The case is of solid drawn brass, with a cap chamber formed in the base, in which an anvil is made by a projection of the material and two fire holes are drilled. The case is not lacquered.

The cap is of copper, and contains .6 of a grain of cap composition, pressed in and varnished, and it may be covered with a tinfoil disc.

The charge consists of about $35\frac{1}{2}$ to $37\frac{1}{2}$ grains of size 5-2 M.D.T. cordite, about 36 to 44 tubes.

A glazed board disc is placed on top of the charge.

The bullet weighs 174 grains. It is more pointed than the earlier marks, the head being struck with a radius of nearly 8 calibres. The envelope consists of an alloy of about 80 per cent. copper and 20 per cent. nickel; the core is in two parts, the front portion consisting of an alloy of 90 per cent. aluminium and 10 per cent. zinc, or pure aluminium, the rear portion of 98 per cent. lead and 2 per cent. antimony. A cannellure is formed around the bullet near the base and this is filled with beeswax. The bullet is secured in the case by the necking of the latter, which is also indented in three places into the cannellure.

.303-inch Ball Cartridge, Mark VI.—The cartridge consists of a case, percussion cap, charge, glazed board disc and bullet.

The case and cap are the same as those used in the Mark VII cartridge.

The charge consists of about 31 grains of size $3\frac{3}{4}$ cordite, in 60 strands.

A glazed board disc is placed on top of the cordite.

The bullet consists of a core made of an alloy of 98 per cent. lead and 2 per cent. antimony, enclosed in a cupro-nickel envelope, and weighs about 215 grains. The envelope is solid drawn from an alloy of 80 per cent. copper and 20 per cent. nickel, and the core is secured inside it by turning over the end of the envelope; a cannellure runs round the bullet near the base. The bottom part of the bullet, except the base, but including the cannellure, is coated with beeswax. It is secured in the case by the latter being necked and indented in three places into the cannellure.

Note.—This ammunition is not now used for Naval Service.

**.303 INCH BALL CARTRIDGE.
MARK VII.**

Scale = 2/1.

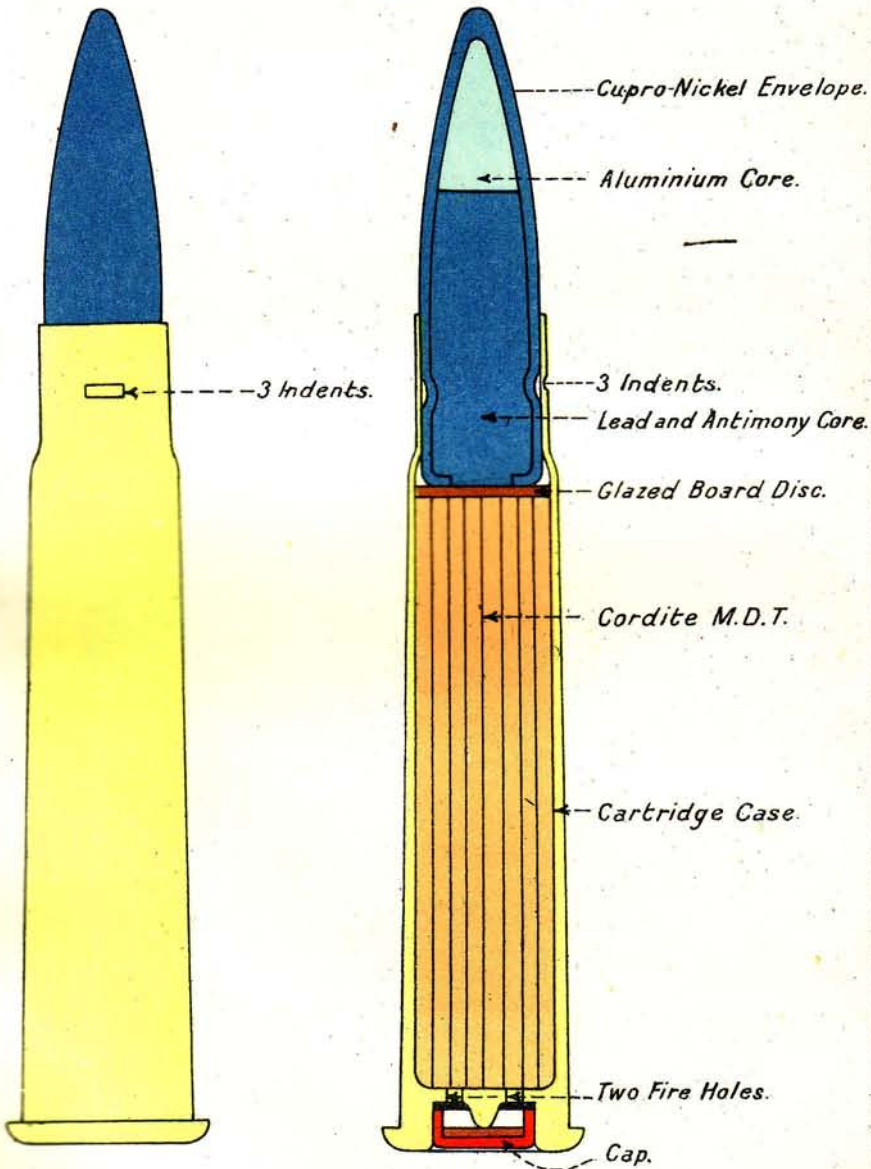

PLAN OF BASE.

Distinguishing mark on box in Green:



Cartridge S.A. Ball .303-Inch (in packets). If in Chargers, and in Cases Charger, the word "CHARGERS" in black is printed diagonally across. If in Bandoliers, the word "BANDOLIERS" is printed diagonally across.

Charger for .303-inch S.A.A.—The Mark II charger is made of steel and holds five rounds. It has a spring stop formed at each end to prevent the cartridges falling out, and is strengthened by having three ridges on the base. The numeral II is shown on the side of the charger.

The Mark I charger has neither the spring stops nor the strengthening ribs on the base.

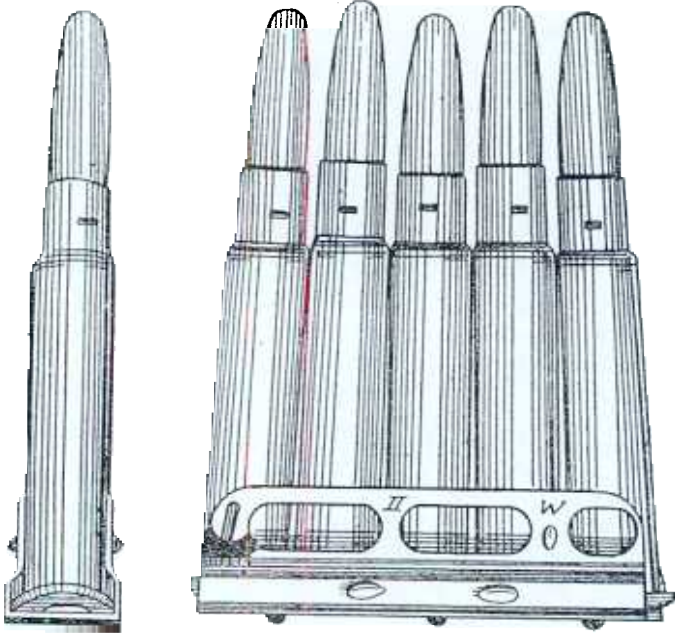

Plan.

Elevation.

Note.—A “charger” is not loaded into a rifle; a “clip” on the other hand is loaded with the cartridges, but clips are not used in the British Service.

Bandoliers for .303-inch S.A.A.—Cotton Bandoliers, Mark II, are used for packing .303-inch Mark VII ammunition in chargers. They are made of khaki-coloured jean, and consist of a body divided into five pockets and provided with a carrying strap. The pockets, each of which holds ten rounds in chargers, are closed by means of fasteners.

Mark I and I* bandoliers differ from the Mark II in being made of drill and, in the case of the Mark I, in having larger pockets divided by single rows of stitching. No more will be made, and as soon as existing stocks are used up, they will be regarded as obsolete.

.303-inch Tracer and Incendiary Ammunition.

S.P.G. Tracer Ammunition is supplied for use with the machine guns of a ship against aircraft, and for aircraft armament.

The cartridges are stamped on the base with a letter G after the Mark VII.

The caps are coloured red.

Incendiary Ammunition.

This is kept in store at depôts and may be issued to aircraft carriers for use by the machine guns of aeroplanes.

These cartridges are stamped in the base with a letter B after the Mark VII.

The caps are coloured blue. This ammunition is not to be stowed below.

S.P.G. and incendiary .303-inch cartridges are packed in S.A.A. boxes. (480 rounds or 1,280 rounds.)

.303-inch Blank Ammunition.

In .303 blank cartridge cases the numeral on the base may not always be applicable to the pattern of cartridge. For instance, any mark of case may be used for a Mark V blank cartridge. If ball cartridge cases are emptied or rejected as unsuitable for filling as ball, the numeral remains if the cases are used for blank.

.303-inch Blank Cartridge, Mark V, without Bullet.—The Mark V blank cartridge consists of a Service pattern case and cap.

The case contains a charge of 10 grains of sliced cordite size 20, on top of which is placed a strawboard wad. The mouth of the case is then necked and crimped.

The Mark VI blank cartridge originally had a mock bullet, but all mock bullets are ordered to be removed.

.303-inch Drill Cartridges.—The Mark III consists of a Service case without the cap; the bullet is of boxwood secured to the case by coning and three indents. Four holes are drilled through the case. The bullet is coloured red.

These cartridges are issued as required, loose in a packing case.

The Mark VI differs from the Mark III in having a metal bullet, and is supplied for use with Lewis Guns.

.303-inch Short Range Practice Cartridge, Mark IV.—This cartridge is for use at certain coastguard ranges. It consists of a Service pattern case and a percussion cap. The case is blackened for a length of $1\frac{1}{2}$ inches from the mouth and contains a charge of about 18 grains of size 4-2 M.D.T. cordite. A glazed board disc is placed over the top of the charge. The bullet consists of a cupro-nickel envelope having a lead core; it is 1.076 inches long, and weighs 188 grains. It is secured in the case by 3 indents. The total length of the cartridge is from 2.9 inches to 2.975 inches.

Webley Revolver Ammunition, Mark II. (Plate 36.)

The cartridge consists of a case, cap, glazed board disc and bullet.

The case is made of solid drawn brass, with a cap chamber formed in the base, in which is an anvil made by a projection of the material, pierced with two fire holes. It has the manufacturer's initials or recognised trade mark, the numeral and the broad arrow stamped on the base.

CARTRIDGE, S. A. BALL, PISTOL, WEBLEY, MARK II.

SCALE - 5/1

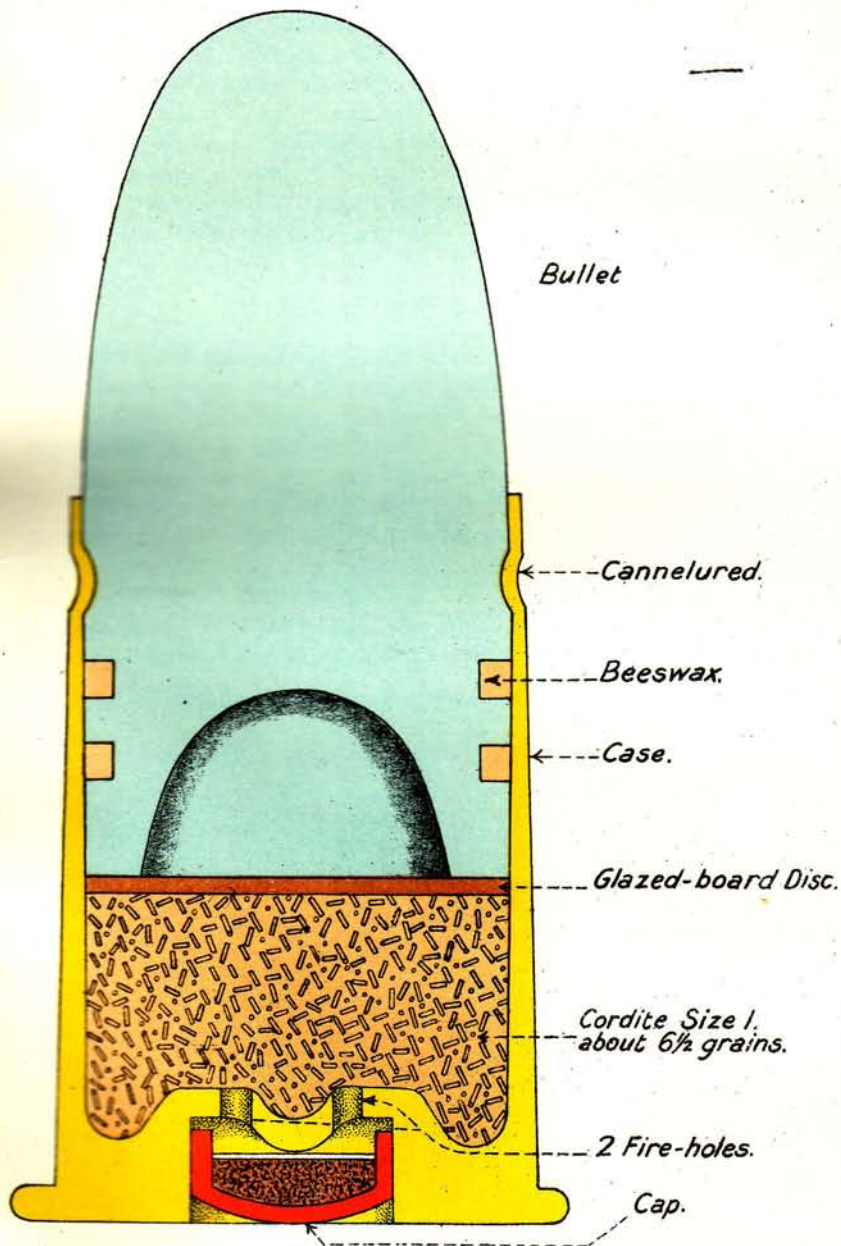

The cap is formed of copper and contains $\cdot 4$ of a grain of cap composition pressed in and varnished, and may be covered with a tinfoil disc.

The charge consists of about $6\frac{1}{2}$ grains of size 1 cordite, length $\cdot 05$ inch. A glazed board disc is placed on top of the cordite.

The bullet is made of an alloy of 12 parts lead and one part antimony, and weighs 265 grains. It has a cavity formed in the base and three cannelures round the body; these cannelures are filled with beeswax, and the bullet is secured in the case by choking the latter into the front cannelure all round.

In the early issues the bullets were of tin and lead.

The Marks IV and V cartridges differ from the Mark II in the bullet, which has a flat head and weighs 220 grains. A slightly heavier charge is used.

The Mark V differs from the Mark IV in the bullet being made of lead and antimony, instead of lead and tin.

Aiming Tube Cartridges.

$\cdot 23$ -inch Aiming Tube Cartridge, C.F., Mark I.—The case is of solid drawn brass with the cap chamber and anvil formed in the base. Two fire holes in the latter communicate from the brass cap to the powder charge.

The charge is $3\frac{1}{4}$ grains of Curtis & Harvey's Diamond No. 2.

The bullet is made of an alloy of 12 parts lead and one part tin, and weighs 37 grains with a tolerance of 3 grains, and there are two wads fastened to its base, that next the bullet being greased and the other of grey cloth.

The Mark II differs from the Mark I only in the arrangement of the wads and in having the base of the bullet slightly recessed.

Note.—This ammunition is not now used for Naval Service.

$\cdot 23$ -INCH AIMING TUBE CARTRIDGE, MARK I.

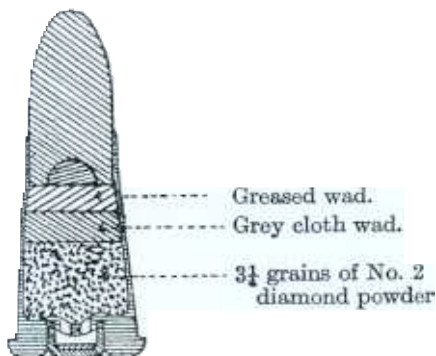

$\cdot 22$ -inch Aiming Tube Cartridge, R.F., No. 1, Mark I.—The case is made of solid drawn copper zinc alloy, the fold in the rim being charged with cap composition.

The bullet is of lead with 1 to $1\frac{1}{2}$ per cent. of tin and weighs about 40 grains, and has three cannellures round it to retain the lubricant.

The charge is 4.7 grains of black powder.

This is the commercial .22-inch long rim fire cartridge.

The No. 2 Mark I has been introduced for use in Webley pistol aiming tubes and differs from the No. 1 cartridge in being shorter and in having a 30-grain bullet. It corresponds to the commercial .22-inch short rim fire cartridge.

.22-INCH AIMING TUBE CARTRIDGE, NO. 1, MARK I.

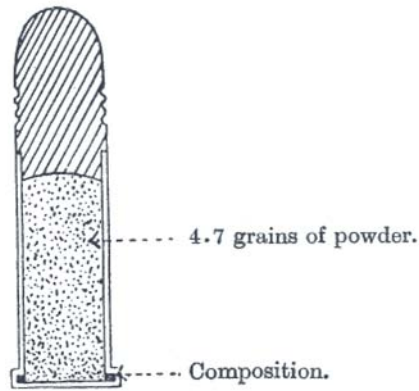

Marking and Packing of S.A. Ammunition.

All cartridges have the following markings stamped on their base :—

- Initials of factory.
- Mark of cartridge.
- Year of manufacture (last two figures).
- Service broad arrow.

All small arm ammunition, except rim fire aiming cartridges, is supplied either in

- Whole S.A.A. boxes,
- Half S.A.A. boxes, or
- Quarter metal-lined cases.

Rim fire cartridges are packed 10,000 in a packing case.

Markings on Boxes.—These have contents labels and labels bearing special devices for each nature of ammunition. These devices are intended for ready recognition and to enable ammunition to be picked out by native porters when such are employed for operations ashore.

These labels are shown in Plate 37.

The date of packing and the initials of the factory are to be found at the end of each box.

DISTINGUISHING MARKS FOR S.A. AND M.G. AMMUNITION BOXES.

Devices of the colours & forms shown are used to distinguish packages & boxes of the several descriptions of small arm & machine gun ammunition mentioned.



1" ELECTRIC AIMING
CORDITE
(Powder in Black)



WEBLEY SCOTT
SELF-LOADING .455"



1" PERCUSSION
AIMING CORDITE
(Powder in Black)



MK VII .303 INCH.
*If in "Chargers" the word
"Chargers" is printed
diagonally across, if in
bandoliers, as on label.*



.45" MACHINE GUN
BALL CARTRIDGE



.22" AIMING RIFLE.



.303" RIFLE BALL
IN PACKETS



CARTRIDGE S.A.
DUMMY DRILL
MAGAZINE RIFLE.



MORRIS AIMING
TUBE .23"



CARTRIDGE S.A. .303"
CORDITE SHORT
RANGE PRACTICE.



PISTOL
WEBLEY .44"



S.A. BALL .303"
IN CHARGERS.

Identification of S.A. Cartridges.

1-inch Aiming Rifle Cartridges.—All 1-inch cartridges, filled cordite, are stamped with the letter "C" on the base.

Cordite filled cartridges have a strip of ORANGE paper showing round the junction between the bullet and the cylinder.

Powder filled cartridges have this paper but it is WHITE.

Electric aiming rifle cartridges can be recognised by the insulating bush round the contact piece of the primer.

Packing.—All 1-inch cartridges are packed in bundles of 12 in brown paper. Eight bundles (96 rounds) go to a large S.A.A. box.

.303-inch Cartridges, Marks VI and VII.—These cartridges are easily distinguished by the shape of the bullet. The Mark VII is the much more pointed.

Mark VII cartridges of the future make will have a dark purple ring painted round the edge of the cap.

Packing.—Marks VI and VII ammunition is packed in bundles of 10 in brown paper, 1,100 rounds to a large S.A.A. box, 500 to a half S.A.A. box and 1,200 to a quarter metal-lined case.

Mark VII ammunition is also supplied 5 rounds in a charger (for use in short rifles), 840 rounds to a large S.A.A. box.

These chargers may be supplied 10 in a canvas bandolier, 850 rounds to a large S.A.A. box.

.303-inch Cartridges for Machine Guns.—These are packed 48 rounds in a cardboard box, 20 boxes 960 rounds in a large S.A.A. box, and 480 rounds in half S.A.A. box.

The boxes are stained green and the labels are marked MACHINE GUNS, BUNDLED.

.303-inch Blank Cartridges.—These are packed 10 in a blue paper packet, 1,450 rounds to a quarter metal-lined case; 3,400 rounds to half metal-lined case, and 7,680 rounds to a whole metal-lined case.

Webley Revolver Cartridges.—These can be distinguished from Webley automatic pistol cartridges because the latter have a bright nickel cased bullet and the rim of the case is countersunk.

Packing.—These are packed 6 in a brown paper packet, 828 rounds in a half S.A.A. box.

.23-inch Central Fire Aiming Tube Cartridges.—These can be distinguished from rim fire cartridges (.22-inch) by their brass cases. Rim fire cartridges have copper alloy cases.

Packing.—They are supplied 100 in a cardboard box, 9,100 rounds in a quarter metal-lined case.

.22-inch Rim Fire Aiming Tube Cartridges (Nos. 1 and 2).—No. 1 cartridge is a longer cartridge than the No. 2.

Packing.—Both types are supplied 100 in a cardboard box; ten boxes go to a square tin, ten of which go to a wooden packing case; 10,000 rounds in all.

CHAPTER XII.

STICK BOMBS, STICKS, EXPLODER AND CARTRIDGES
FOR ANTI-SUBMARINE USE.

Introductory Remarks.

Against a submarine on the surface the flat trajectory fire of ordinary high velocity guns is not a fully satisfactory means of offence and against a submerged submarine it is useless. To disable the enemy it is necessary to damage the "pressure hull."

During the war special weapons were developed, which fall broadly into two types, both being designed to burst under water.

- (1) Stick bombs of large capacity which can be thrown by bomb throwers, howitzers or ordinary B.L. or Q.F. guns. These are in the nature of "depth charges" which can be thrown to a distance.
- (2) Bombs or shells of high capacity which can be fired from high trajectory bomb-throwers or howitzers.

Stick Bombs. (Plate 38.)

The stick and bomb are separate components.

There are four sizes of bombs, which are referred to by their nominal weights (the weight of the bomb together with the weight of the normal stick used with it), known as 200-lb., 350-lb., 500-lb. and 600-lb. stick bombs.

All these bombs are of similar design.

The 200-lb. bombs consist of a spherical cast steel body in two parts welded together. Two holes are formed in the body, one at the top and one at the side; the former being fitted with a metal bush to receive a plug, and the latter being fitted with a metal bush and tin container for the reception of an exploder and the hydrostatic valve fuze. This bush is closed during transit by a plug.

A cast steel socket for the stick is riveted and welded to the bottom of the bomb. The bomb may be filled with trotyl, but the majority are filled with amatol 40/60—that is, 60 per cent. of pure trotyl and 40 per cent. 1st grade ammonium nitrate.

Exploder.

The Mark III exploder consists of two C.E. pellets and a 30-grain detonator in a copper container.

Mark IV exploder with 2 C.E. pellets and 56-grain detonator supersedes the Mark III exploder for 200-lb. bombs.

The Mark II bomb has an exploder container of steel which is screwed into the metal bush.

200 LB. NAVAL STICK BOMB.

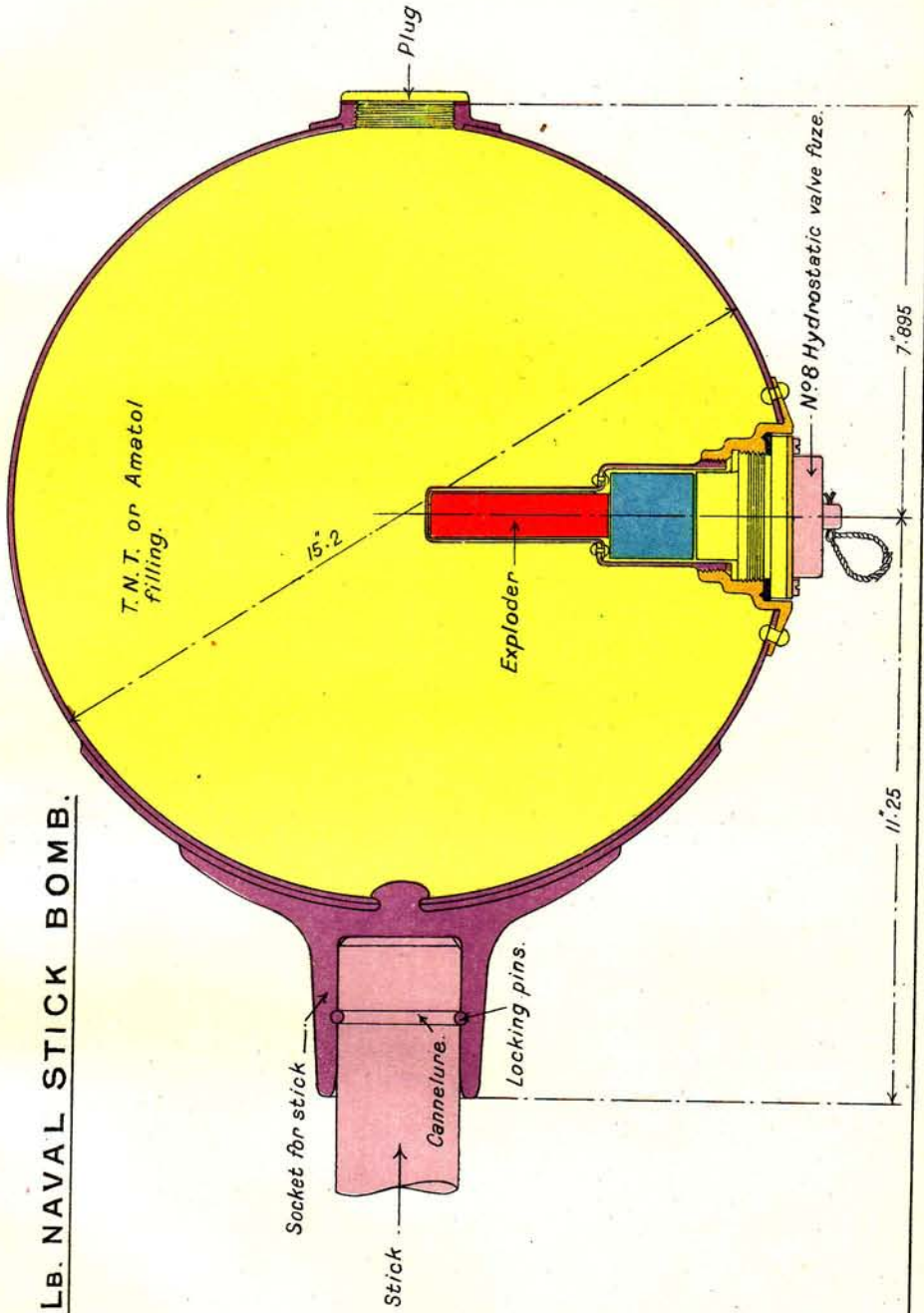

STICK BOMB CARTRIDGE, MARK I, FOR 4.7 INCH MARK I GUN.

3 LB. 14 OZ. CORDITE M. D. T. 15-13.

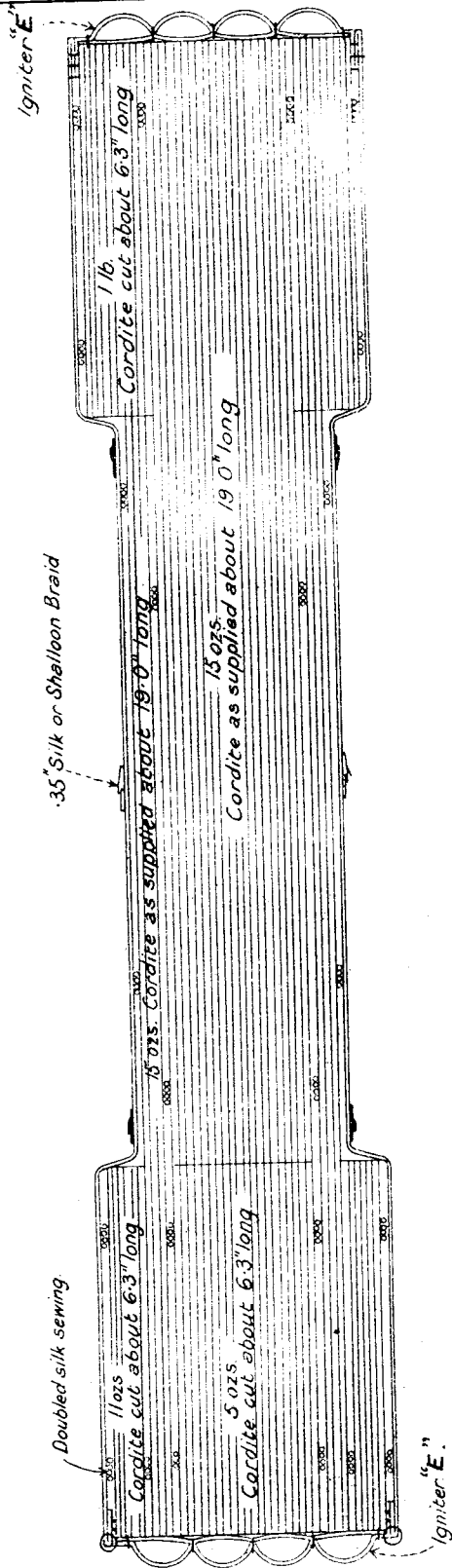

CARTRIDGE, 12 PR 12 CWT, MARK II, FOR STICK BOMB. 1 LB. CORDITE M.D.T. 15-13.

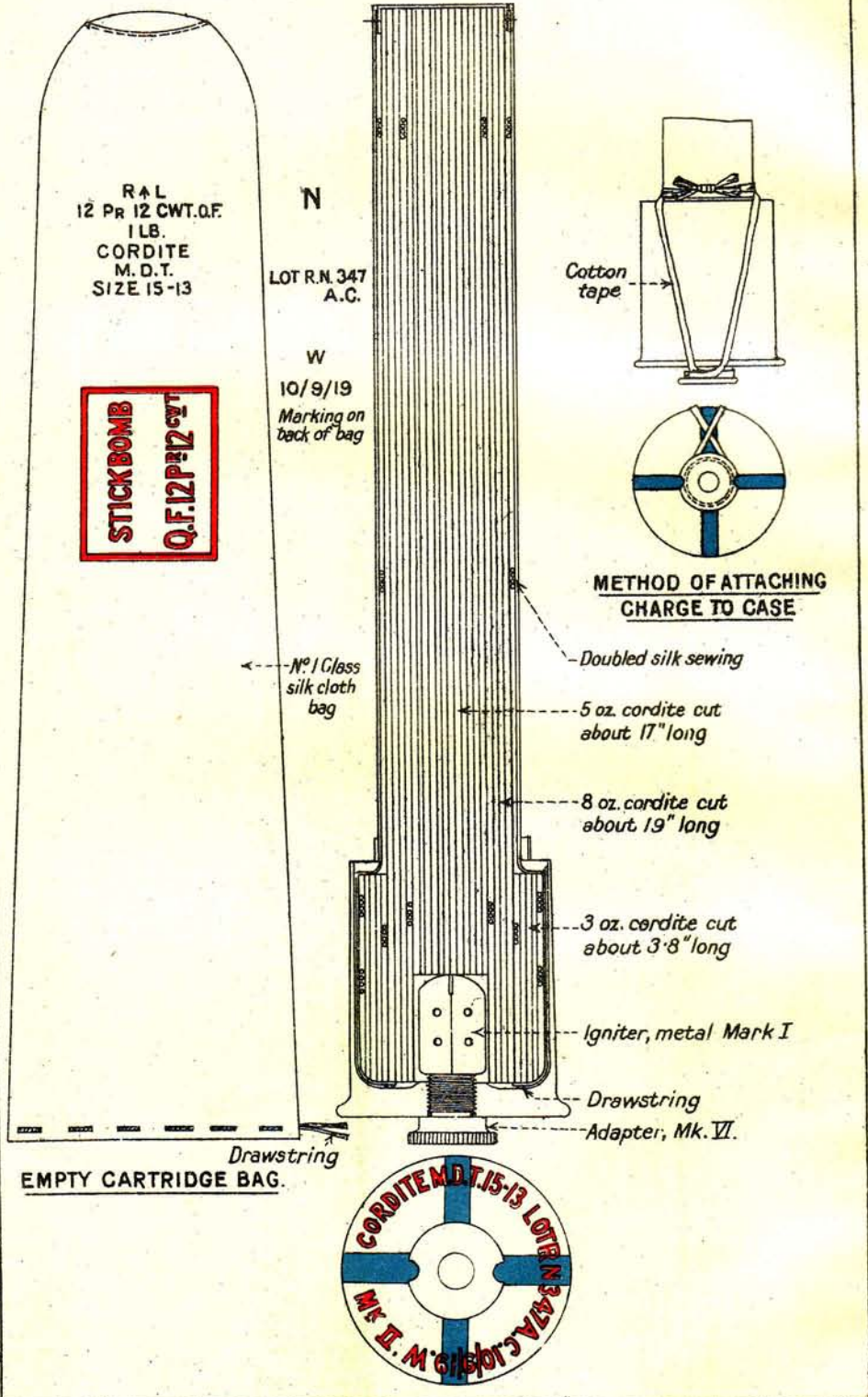

Sticks.

Sticks for Stick Bombs.—They consist of a forged steel rod carrying three piston-like discs. These discs have recessed into their outer surfaces a copper band which fits closely into the bore of the gun. A light gas-check disc is provided at breech end of stick to reduce erosion.

The sticks also carry at the head a disc of greater diameter than the bore of the gun, which thus serves to limit the distance the stock can be inserted into the bore.

Cartridges for use with Stick Bombs.

(a) **B.L. Guns used as Stick Bomb-Throwers.** (Plate 39.)—The cartridges used are of ordinary B.L. type. The Mark I cartridge for B.L. 4·7-inch Mark I gun (3 lbs. 14 ozs. M.D.T. 15–13) is of dumb-bell shape consisting of a cordite of bundles of 6·3-inch lengths (5 ozs.) and 19-inch lengths (15 ozs.) butted together. Around one end of this is bundled 15 ozs. of 19-inch lengths and around the other end is bundled 1 lb. of 6·3-inch lengths. This latter bundle completes one end of the charge; the other is completed by a bundle of 6·3-inch lengths (11 ozs.).

(b) **Q.F. Guns used as Stick Bomb-Throwers.**—Cartridges for these guns consist of a charge of cordite contained in a silk cloth bag and fitted with an igniter. The igniter end of the charge is contained in a short brass cartridge case (usually ordinary Service cases cut down to the required length) fitted with the means of ignition, primer or adapter, particular to the gun. The charge is secured to the case by a length of cotton tape tied to the clip for primed cases or to the adapter and round the charge. The tape must be removed before loading. As examples of the methods of make up, one cartridge of each type, primed and adapter fitted, will be described in detail.

(I) **Cartridge Q.F. 4-inch Mark IV Gun, filled 2 lbs. 2 ozs. Cordite, M.D.T. 15–13, Mark I.**—The charge consists of 1 lb. 9 ozs. of cordite 19 inches long, round one end of which is bundled 9 ozs. of 6·3-inch lengths. The charge is contained in a silk cloth bag and an igniter containing 1 oz. of powder is secured to the larger end of the cartridge. The cartridge is of ordinary Service pattern cut down to a length of 7 inches and fitted with No. 1 primer. The cartridge is secured to the case as described above.

(II) **Cartridge Q.F. 12-pdr. 12 cwt. Mark II, filled 1 lb. Cordite M.D.T. 15–13.** (Plate 40.)—The charge consists of a core of 5 ozs. of 17-inch lengths round which is bundled 8 ozs. of 19-inch lengths leaving a recess of 2 inches at one end. Around the recessed end is bundled 3 ozs. of 3·8-inch lengths. The charge is contained in a silk cloth bag closed at the smaller end of the charge and partially closed by means of a draw string at the larger end, leaving the recess in the charge open. The cartridge case is of Service pattern cut down to 4½ inches and is fitted with Adapter Mark VI and metal igniter. The cartridge is inserted in the case so that the

metal igniter enters the recess in the charge. The cartridge is secured to the case as described above.

Marking on Bombs, Stick Bombs and Shell, and Cartridges.

Bombs, stick bombs and howitzer shell are painted yellow with a green band round the body to denote H.E. filling.

Projectiles when filled have a red band round the nose or upper part of the body. When filled with amatol the figures 40/60 are added in black below the green band and the filling ring is made up of red crosses.

Cartridges.—Cartridges made up as B.L. cartridges are marked with the usual stencilling on the bag.

Cartridges special for stick bombs have

Stick Bomb. (Calibre and Mark of Gun)

in red

on the same side as the weight of the charge and nature of gun.

Q.F. cartridges for stick bombs are marked by stencilling in red on the projecting portion of the charge

Stick Bomb. Q.F. 12-pdr.

and blue cross painted on the base of the case.

Packing.—Bombs are packed in skeleton packing cases.

ROCKET, SIGNAL, 1LB, SERVICE, MARK III.

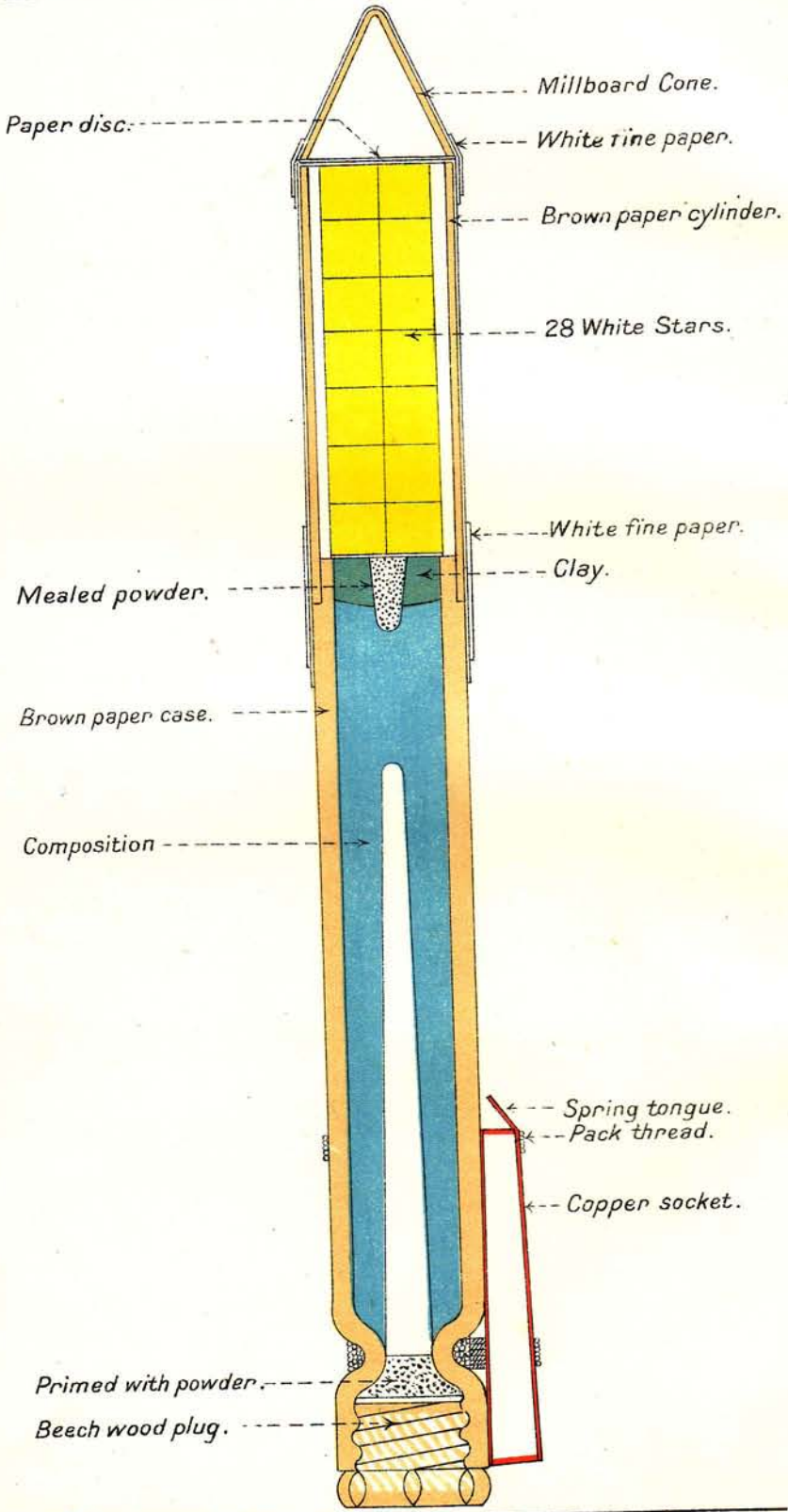

CHAPTER XIII.

PYROTECHNICS.

Section 1.

Rockets are employed for signalling and for display.

A rocket consists of a cylinder, closed at the head and having a vent at the rear end. This cylinder contains a quick burning composition having a conical recess up the centre. The ignition of the composition causes a pressure of gas in the rocket and this gas, escaping through the vent, presses against the air and propels the rocket.

It is necessary to provide some means of keeping a rocket travelling in the direction in which it started, for if the rocket were a simple cylinder it would tend to turn over and over, for the centre of gravity is always altering as the composition burns away. Therefore a long stick is secured to the rear end of the rocket cylinder. The signal portion of a rocket is contained in a cylinder and secured to the forward end of the rocket.

In order to reduce the area over which the destructive effect of the accidental ignition of a store of rockets would extend, most types of rockets are fitted with a beech-wood plug in the vent. Rockets so fitted will burst on ignition instead of being projected. The wooden plug must, of course, be removed when the rocket is required for use.

Instructional labels are pasted on the bodies of all rockets.

The following types of rockets are used in N.S. :—

- (a) Rockets containing coloured or white stars, such as Service rockets, signal rockets.
- (b) Rockets containing a charge of guncotton or tonite and a detonator in the head. These are known as sound rockets.
- (c) A combination of (a) and (b) known as light and sound rocket.

Rockets are supplied one in a tin cylinder, sealed with a soldered strip. These tins are made in two diameters, so as to fit the head and body of the rocket. They are supplied in wooden packing cases.

Signal Rocket, 1-lb., Service Mark III. (Plate 41.)

The body of the rocket consists of a cylinder of brown paper closed at the top by a perforated clay plug. A cylindrical brown paper head with conical cap is secured to the front of the body by glue, a strip of paper being pasted and wound round the joint.

The body of the rocket is filled with rocket composition and the head contains 28 white stars in tiers and some mealed powder

which serves to open the head and scatter the stars. The mouth of the recess in the rocket composition is primed with powder and the rocket is ignited in the vent by means of a portfire; no safety fuze is provided. The copper socket that takes the end of the rocket stick is secured to the rear end of the body by pack thread.

A screwed wood plug is provided for closing the end of the rocket during transport and storage.

The exterior of the rocket is painted drab colour.

Signal Rockets, 1-lb., Red, Mark II.

Blue, Mark II.

Green, Mark II.

These rockets only differ from one another in the colour of the stars and are similar in construction to the 1-lb. Service rocket described above, except that the head is larger, fitted with a rounded cap and filled with 49 coloured stars in seven tiers. The stars are packed in with quick-match, which ignites them and opens the head.

The body of the rocket is painted drab colour and the head red, blue or green according to the colour of the stars contained therein.

Signal Rockets, $\frac{1}{2}$ -lb., Red, Mark II.

Blue, Mark II.

Green, Mark II.

These are similar in construction and are painted in the same manner as the corresponding 1-lb. rockets, but are smaller and contain 30 stars in 6 tiers.

Sound Rockets, $\frac{1}{2}$ -lb., Mark II. (Plate 42.)

The body of the Mark II rocket is of similar construction to that of the $\frac{1}{2}$ -lb. Red, Blue, or Green rocket, but the head is closed by means of a calico bag tied with tape.

The head contains a 2-oz. slab of guncotton perforated to take a No. 1 or No. 3 detonator. The detonator is connected with the rocket composition by quick-match.

Detonators, guncotton slabs and rockets are issued and stored separately, the complete rocket being assembled for use when required. A safety fuze is provided.

The Mark II rocket is painted drab colour.

Light and Sound Rocket, 1-lb., Mark I.

The general construction is the same as for Rocket Signal 1-lb. Service Mark III. The head, which is closed by a wood plug, bayonet jointed, contains a tonite charge in addition to the star. The tonite charge is recessed to take the No. 2 or 3 detonator and is separated from the star by a perforated felt wad. Tonite charge, detonator and rocket are supplied and stored separately. A safety fuze is provided.

The head of the rocket is painted red and the body drab.

ROCKET SOUND 1/2 LB. MARK II.

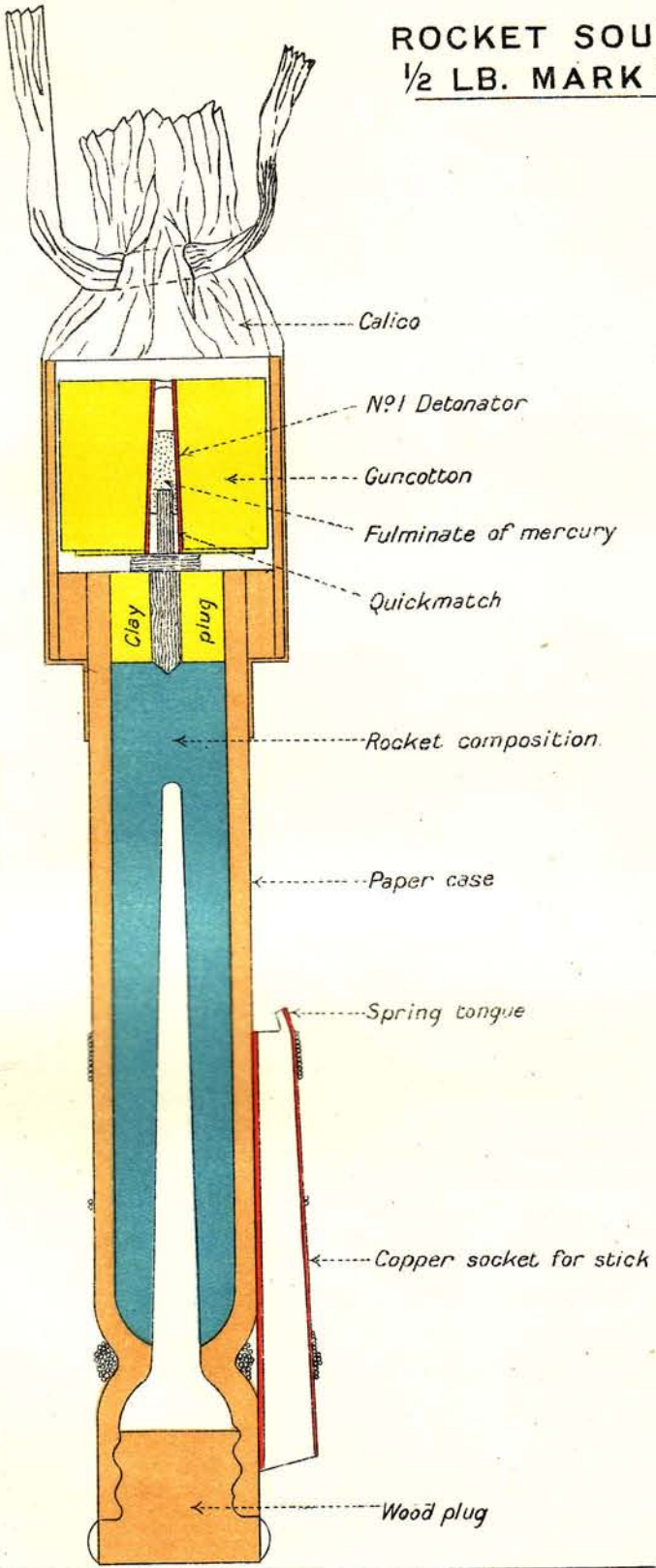

Method of Firing Sound Rockets.

First place the rocket on the stick, being careful to see that the tongue bites into one of the notches in the stick.

Take the guncotton charge and without force rectify the hole, a wooden rectifier being supplied for the purpose; then place the detonator carefully into the charge, turn the rocket and stick upside down and enter the guncotton charge and detonator into the rocket, holding the guncotton charge with the detonator on top; next turn the rocket the right way up and secure the calico covering with the tape. Place the rocket in the upright, keeping the latter in a perpendicular position.

The rocket may be fired by igniting the priming of F.G. powder in the base by any available means such as a portfire, &c., or by igniting the safety fuze on the rocket. Before igniting by either method, the wooden plug in the base of the rocket must be removed.

On the flame reaching the composition inside the rocket the latter will ascend into the air. The burning composition will eventually reach the strands of quick-match, which will in turn ignite the detonator and so detonate the guncotton charge, which makes a loud report resembling the firing of a 3 or 6-pdr. gun.

Friction Tubes.

Friction tubes are used to fire signal rockets from a rocket machine and also the Signal, Socket, Light and Sound.

Copper Friction Tube, Mark I, for Machine Rocket Signal and Signal, Socket, Light and Sound.

This consists of a solid drawn copper tube closed at the head. It is filled with pistol powder and closed with a cork plug. About a quarter of an inch below the head a small hole is bored through the side; a bulge is made on the inside opposite it, forming a seat for the crown of the solid drawn copper nib piece which is inserted and soldered; a small hole is bored through the underside of the nib piece inside the body to enable the flash from the detonating composition to ignite the powder. The nib piece contains a copper friction bar roughened on both sides and slightly twisted at the ends and smeared with detonating composition composed of chlorate of potash, sulphur and sulphide of antimony. This composition is damped with shellac varnish while it is being smeared on. The nib piece is pressed down on to the sides of the friction bar. The projecting part of the friction bar has a vertical eye, into which the hook of the rocket machine or the lanyard fits; the junction of the nib piece and friction bar is sealed by shellac varnish.

Note.—When used for firing Signal Rocket light and sound the friction tube is enclosed in a paper wrapping.

Action.—On pulling the lanyard (which should be stretched and then sharply pulled) the friction bar is drawn out, igniting the composition and firing the tube.

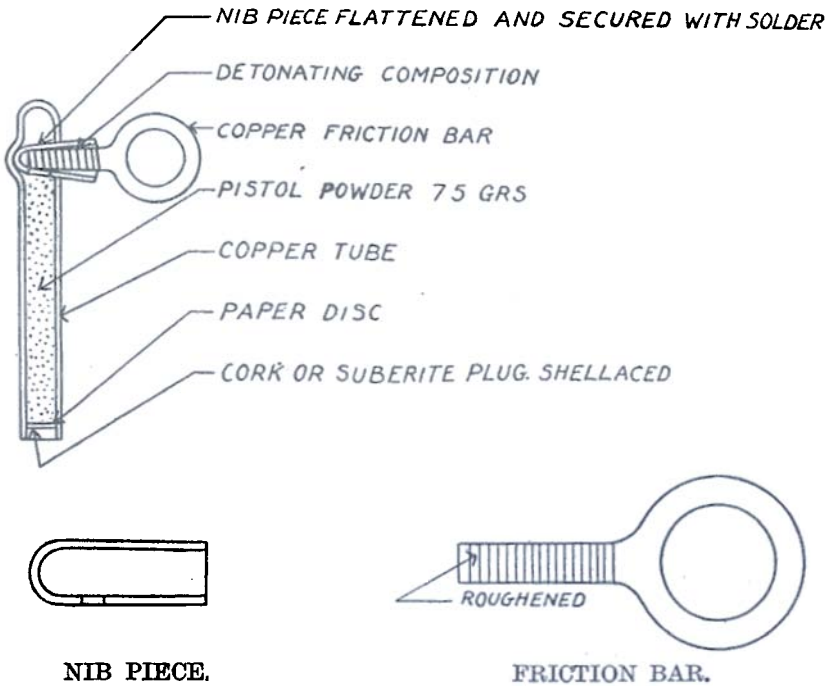
Copper Friction Tube, Mark I.**Section 2. Lights and Flares.****Coastguard, Light, Mark II.**

This consists of a brown paper cylinder closed at one end by a clay plug and a partly coned beech-wood plug, on to which a cone of tin is secured by three iron nails. The cylinder is filled with six pellets of light composition. A layer of igniting composition is pressed in on top and the cylinder is closed by a paper cap fitted with a stripping tape.

A wooden plug with igniting composition at one end is contained in a paper cylinder attached to the side of the light.

The light is painted drab colour with "Light Coastguard II" stencilled on the side. A label, giving directions for lighting, is provided.

The light burns for about 5 minutes. The object of the tin cone is to enable the light to be stuck in the ground.

Long Light, G.S., Mark III.

This consists of a paper cylinder into which is pressed a column of light-giving composition. The top of the composition is covered with a calico disc, smeared with igniting composition, covered and protected by a paper disc and a paper cap under which is glued a piece of tape for stripping purposes. At the bottom of the composition is a plug of clay. A beech-wood handle is then inserted

into the bottom of the cylinder till it bears against the clay plug. The handle is secured to the cylinder by shellac and has a recess at the lower end into which fits a wooden plug, the top end of which is coated with igniting composition. The light burns for about 5 minutes. The light is painted drab with "Light, long, G.S. III" stencilled on the side. A label, giving directions for use, is provided.

To ignite the light, tear off the disc, pull out the plug, and draw its primed end lightly across the prepared surface, holding the light so that it points away from the body. On no account is the prepared surface to be struck with the igniter.

Light, Long, G.S., Mark III.



Short Light, G.S., Mark II.

This differs from the Light, Long, G.S., Mark III, having a shorter cylinder and less light composition. It burns for about $1\frac{1}{2}$ to 2 minutes with a very brilliant white flare. The painting and marking is similar to that for the long light except that the stencilling reads "Light, short, G.S., II N."

Light, Long, Red, Mark III.

" " **Blue, Mark III.**

" " **Green, Mark III.**

These are made up similarly to the Light, Long, G.S., Mark III, differing from it, and from one another, in the nature of the composition used.

The bodies of these lights are painted the same colour as the light produced.

The Red and Blue Lights burn from 2 to $2\frac{1}{2}$ minutes, and the Green from $1\frac{1}{2}$ to $1\frac{3}{4}$ minutes.

The Long and Short Lights are supplied one in a sealed tin cylinder.

Common Portfire.

This consists of a cylinder $16\frac{1}{2}$ inches long, and $\frac{3}{4}$ -inch in diameter. It is made of stout brown paper pasted, rolled, and, when dry, turned in at one end to form a bottom. The case or cylinder is filled with portfire composition in the form of pellets.

There is a small hole bored in the top pellet, and is primed with mealed powder to make it light easily. A portfire burns from 12 to 15 minutes, and is generally lit by slow-match, or any other handy means, and is not extinguished by water. To put it out, cut off the burning end.

It is used for incendiary purposes. A portfire holder is supplied.

Slow-Match.

This is made of pure hemp slightly twisted and boiled in a ley of water and wood ashes. It may equally well be made by boiling in a solution of 8-ozs. saltpetre to 1 gallon of water.

It burns at the rate of 1 yard in 8 hours, and is used for keeping a light going in a boat, &c.

About 4 yards of it go to a pound. It should be demanded by weight.

Quick-Match.

This is used particularly for priming and is made of cotton wick boiled in a solution of mealed powder and gum, and afterwards dusted over with mealed powder before it is quite dry. When not enclosed it burns at the rate of about 1 yard in 13 seconds, but it is practically instantaneous when enclosed.

Safety Fuze.

This consists of a train of F.G. powder enclosed in jute yarn contained in a tube of gutta-percha with an outer covering of water-proof tape.

It burns at the rate of 1 yard in 60 to 100 seconds.

It is used for exploding charges, *e.g.*, demolitions, and will burn under water.

It can be easily ignited by a portfire, but there is a special pistol supplied for the purpose. The pistol is breech-loading and has a cartridge specially made for it. The charge is 3 grains of R.F.G. powder.

Section 3.**Grenades and Signal Cartridges.**

Grenades are fired from the Service rifle by means of a blank charge. V.B.S. lights, day and night grenades are supplied for special signalling purposes, and either of present or future stocks are only to be expended when on actual service or when specially authorised by the Admiralty.

Their use for illuminatory purposes is forbidden under all circumstances, owing to the fact that the arrangements of stars, colours, &c., in the grenades and V.B.S. lights are secret.

When the grenades function, the signal portion is ejected and displays a smoke candle or stars, suspended from a parachute.

·303-inch Rifle Grenade No. 32, Night Signal, Mark III. (Plate 43.)

The body is cylindrical and made of tin. The base cover, also of tin, is a sliding fit over the rear end of the body, and after the grenade has been filled, it is secured to the body by means of a paper band pasted over the joint. A steel washer screwed to take a steel rod 15 inches long is soldered to the outside of the base of the cover. The top of the grenade is closed by means of a tin plate lid soldered on, having a central hole. Over this hole is soldered a boss threaded to take the striker chamber. The striker chamber is tubular, enlarged at the base to form a recess for the head of the

GRENADE.

.303 INCH, RIFLE, N° 32, DAY OR NIGHT, SIGNAL. MARK III.

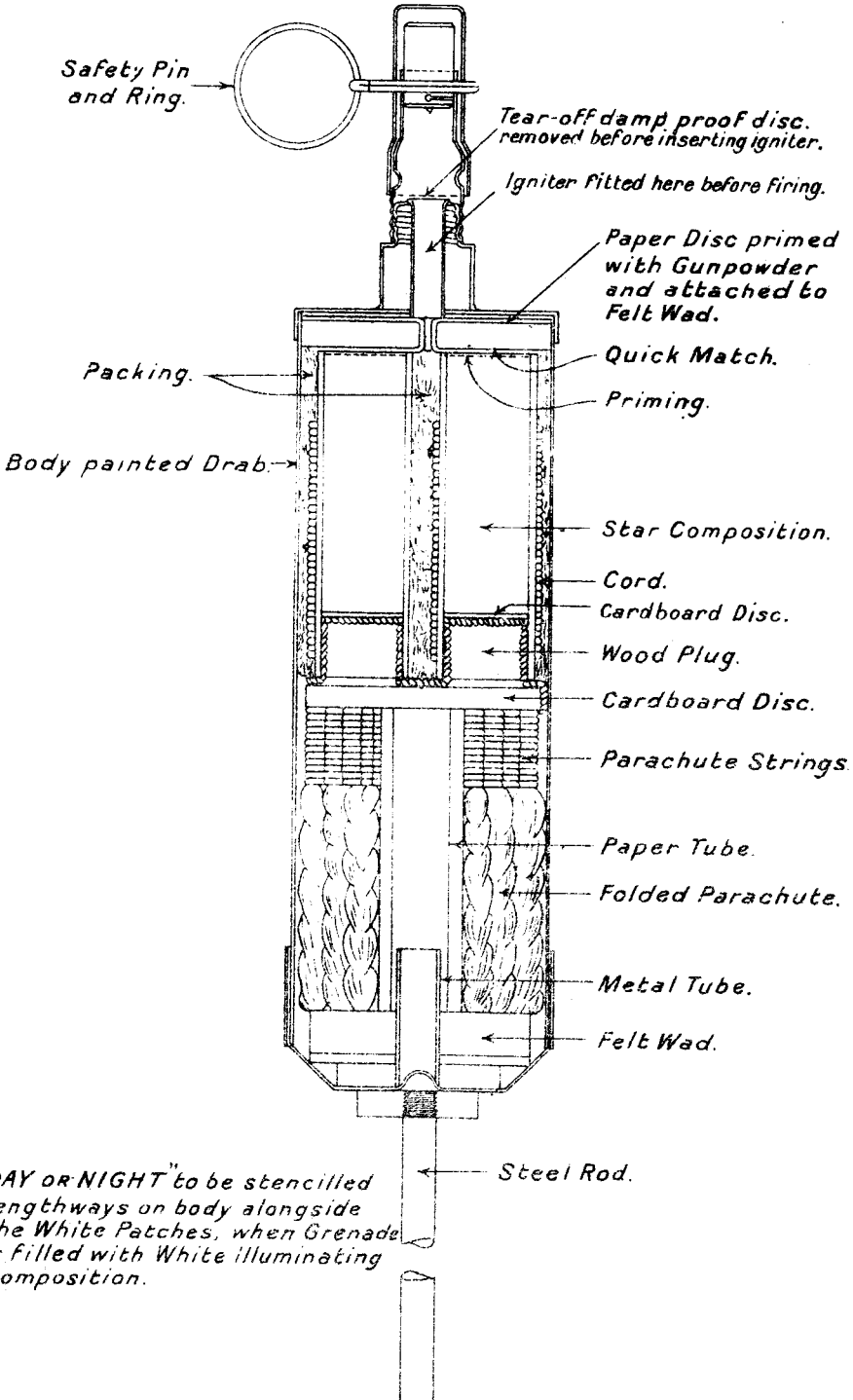

igniter and is threaded to suit the screwed boss on the head of the grenade. The striker, which is made of brass, is held in position by a copper shearing wire which passes through holes drilled in the striker and striker chamber. A brass cover is secured over the striker chamber by means of solder, and a safety pin passes through corresponding holes in the cover, striker chamber and striker. The igniter, which is not placed in position until the grenade is ready for firing, consists of a .410 Ely cartridge case, cut down and fitted with a percussion cap, secured to a length of safety fuze giving a time of burning of about three seconds. When the igniter is not in position the end of the igniter tube on the top of the grenade is closed by means of a tear off "damp-proof disc."

The grenade is filled through the bottom. A primed disc attached to a perforated felt wad is placed at the top of the grenade with the primer disc next to the igniter chamber. Strands of quick-match are passed through the perforation and connect the igniter chamber with the interior of the grenade.

The stars consist of cardboard cylinders filled with composition, and are inserted in the grenade so that the primed ends are in contact with the felt wad and quick-match. The parachute cords and parachute are folded round a paper tube and inserted behind the stars. Felt wad and cardboard discs are placed behind the parachute to make a secure package; the base cover of the grenade is then placed in position, so that the metal tube secured to the base cover passes into the paper tube. The base cover is then secured to the body of the grenade by means of a paper band.

The body of the grenade is painted drab and has coloured dots painted on the side to show the colour and order of the stars. The dots are so placed that, when the grenade is in position for firing, the order of the stars is indicated as they will appear on functioning.

Action.

Before firing remove striker chamber with cover, tear off damp-proof disc and insert igniter. Replace striker chamber with cover; then withdraw safety pin.

On shock of discharge the striker sets back and fires the cap and this in turn ignites the safety fuze. This burns for about 3 seconds before igniting the blowing charge; at the same time the quick-match priming of the signalling device is lighted. Explosion of the blowing charge blows out the base and the stars and parachute are ejected. At extreme height of trajectory, the parachute opens out and supports the burning stars.

.303-inch Rifle Grenade No. 31, Daylight Signal, Mark IV.

This is similar to the Mark III night signal, except that a different form of signal is used, viz., a smoke candle instead of stars. The colour is indicated by serpentine lines stencilled on the body of the grenade.

Section 4.

Signal Cartridges, 1-inch, Marks IV and V.

These are issued for signalling purposes and contain a single red, green or white star. The Mark IV cartridge has a solid drawn brass case lined with cardboard. The Mark V cartridge has a cardboard case, but is fitted with a metal base.

The base of the case is fitted with a cap chamber, percussion cap and anvil. When the cap is struck, it ignites the charge of loose powder, which ejects the star, at the same time lighting the quick-match would round the star composition. The star composition is contained in a calico wrapper, which is retained in position by felt wads. A closing disc seals the mouth of the case, which is turned over to hold the disc in place.

Distinguishing Marks.

(1) A coloured circular paper, denoting colour of star, with the colour also printed on it, is attached to the closing disc.

(2) The paper portion projecting beyond the mouth of the case is painted the colour of the star.

(3) In the Mark V cartridge, a $\frac{1}{8}$ -inch band of the same colour as the star is painted round the case.

(4) The rim of the case is milled all round in the case of the red star (R-ed feels R-ough), is plain in the case of a green star (G-reen feels G-reasy), and is milled half the way round for a white light.

Signal Cartridge, 1 $\frac{1}{2}$ -inch.

These are similar to signal cartridges 1-inch.

The following cartridges are made up in a cardboard case fitted with a metal base :—

Red Mark I.
Green Mark I.
White Mark II.

The following cartridges are made up in solid drawn brass cases :—

Red Mark II.
Green Mark II.
White Mark III.

Signal Cartridge 1-inch are stowed in the firework tank, or in the shell room if there be no firework tank. They are supplied six in a brown paper packet, 120 rounds in a quarter metal-lined case.

Signal Cartridge, 1-inch, Yellow Smoke.—One-inch yellow smoke signal cartridges are supplied to ships of the Atlantic Fleet, they are to be stowed on the weather deck and not in the firework tank or shell rooms. No more of the cartridges will be made.

Signal Light Pistols are to be examined every six months and the pull-off of the trigger tested. When not cocked a pressure of from 7 to 10 lbs. should be necessary to compress the trigger spring.

Socket, Signal, Light and Sound, Mark I.

This is used for signalling purposes and contains a sound charge and either red or green stars.

It consists of a tinned steel cylinder, closed at the head or top with a beech-wood plug, covered with a rubber bag, and at the base or bottom end with a tinned steel cap to which is soldered a cast iron plate. At the rear end over the cap is fitted a rubber bag containing the propelling charge of blasting powder.

Down the centre runs a brass tube leading to the propelling charge, the forward end of the central tube being fitted with a beech-wood plug, which is only removed when signal is ready for firing and copper friction tube is to be inserted.

The head of the cylinder contains either five red or four green stars, shaped in the form of rings round the central tube. The rear star, in contact with the tonite charge, is recessed to take a gunpowder priming ring. The priming ring is separated from the star by means of a straw paper washer.

The rear part of the cylinder contains the sound producing charge of 4-ozs. of tonite, two lengths of time fuze and a special detonator, consisting of $8\frac{1}{2}$ grains of time fuze composition and 25 grains of fulminate of mercury.

The socket from which the cartridge is fired is a metal mortar, into which it fits loosely.

The propelling charge is fired by means of a copper friction tube inserted in the end of the central tube, from which the wood plug has been removed.

On discharge, the time fuzes are ignited and they in turn ignite the priming ring. The latter then lights the star cases and by means of the detonator fires the tonite charge. The force of the explosion splits up the base plate and ejects the stars.

The beech-wood plug in the head is painted according to the colour of the signal.

A brass label marked "Explosive Dangerous" is soldered round the cylinder.

Firework Boxes.

Signal Rockets, Portfires, and Tin Cylinders containing Lights are packed in firework boxes; large and small.

These boxes will pack the following stores:—

Stores.	Large Box.	Small Box.
Lights, short - - - - -	24	16
Portfires, common - - - - -	14	10
Rockets, signal (1-lb.) - - - - -	24	12

The lids are screwed down by a metal-lined key.

Firework boxes are stowed in the firework tank or shell room, and the various boxes on deck and elsewhere are replenished from them.

These are :—

Boat's magazines, night signal box, and sea boat's box.

The **Night Signal Box** is supplied for the stowage of stores which may be needed at a moment's notice for signalling purposes. Two boxes are supplied to flag ships, one to other ships.

The night signal box is to be placed where it can be readily got at.

Night signal box contains :—

3 signal rockets in tin cylinders.	1 Very's pistol, 4 green, 4 red, and 4 white
2 short lights. 25 copper friction tubes for machine rocket signal.	Very's lights.

The rocket tube, with a stick in it ready for use and some spare sticks, are always to be kept close to the box.

The night signal box is provided with a lock and key.

A sea boat's box is supplied for each sea boat.

Sea boat's box contains :—

4 short lights.

1 Very's pistol.

10 Very's lights, 5 green and 5 red.

The gunner is responsible, and will report to the captain on proceeding to sea, that a sea boat's box is in each sea boat. Every evening at sea he will satisfy himself that they are there and report as before.

The list of stores and stowage of the magazines for the different classes of boats are given below :—

Boat's Magazine.

For Boats armed with 3-pdr. Q.F. or Maxim Gun.

204 rounds of pistol ammunition in a leather pouch.
1 lb. of slow match.
1 key for metal-lined cases.
2 signal rockets.
2 sticks with rope tails.
2 common portfires.

Gig's Magazine.

As supplied to each boat armed with rifles only :—

1 signal rocket.
 1 stick with rope tail.
 1 common portfire.

96 rounds of
 pistol ammunition
 in leather pouch.

1 key for metal-lined cases.
 1 strap for pouch.
 1 lb. of slow match.

Steamboats are at all times to carry a Very's pistol, six of each coloured Very's lights, and six short lights for signalling purposes.

NIGHT LIFE-BUOY.

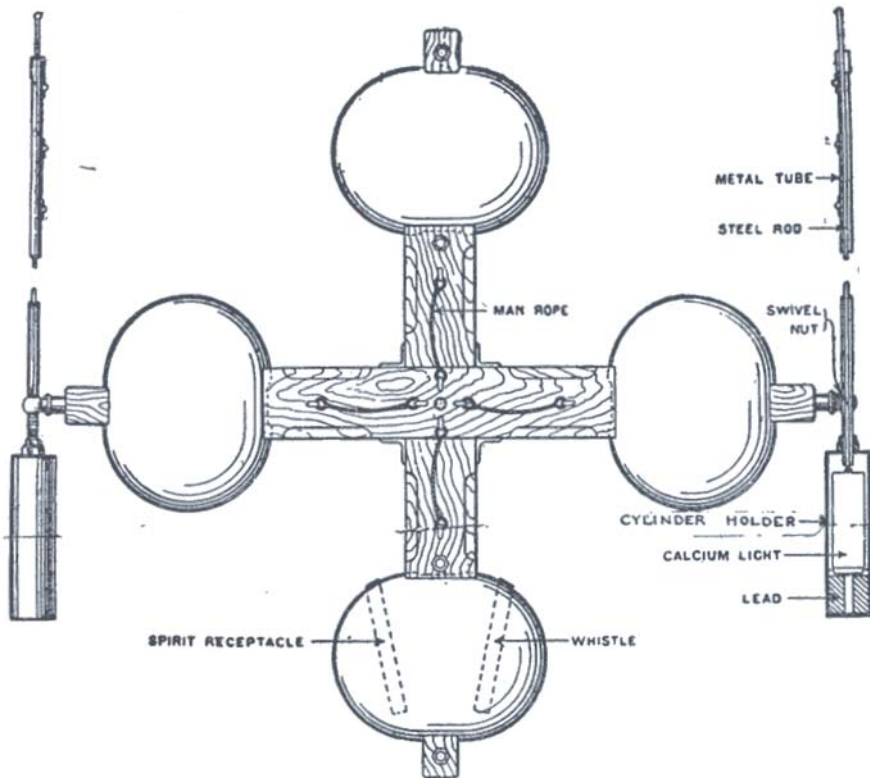

Life-Buoys.

The latest pattern of night life-buoy is shown in the woodcut.

To each buoy is attached an arrangement for carrying the calcium light as shown, but to the earlier pattern of circular buoy the light was attached to a float, which was connected by four feet of chain to the buoy.

On the buoy being let go, the steel rod being held, the stopper is torn out of the light, and water entering through a hole in the

bottom of the holder, gets access to the calcium, and causes ignition. A flame will shortly appear and continue for about half an hour at the top of each tube.

The following regulations are to be observed (K.R. and A.I. 1913, Arts. 540 and 641) :—

(a) Life buoys are to be tested once a week, by letting go without the calcium lights being placed if in harbour, or by lowering the buoy about a foot if at sea, first unscrewing the steel rods from the lights. Also after coaling, painting, or going alongside where hawsers, &c., are likely to have bent the guide rods.

(b) The result is to be entered in the ship's log book.

(c) The buoy should also be tried every six months with lights and rods in place, and the results entered in the ship's log and gunnery log.

(d) The buoys are to be let go on all occasions of the ship's company bathing, so as to accustom the men to their use, the calcium lights being first removed.

(e) The lights are always to be in place and the buoy ready for service, except when testing as above; care is to be taken when painting ship to avoid the trigger bolts and other working parts.

(f) When the ship is in dry dock, the buoys are to be lashed or unshipped.

(g) Lights are supplied 10 for each buoy but not to exceed 20 per ship, and are always to be kept in the boxes provided for them, which are not to be stowed in the magazine, but kept in a dry store-room where they are not likely to ignite by being damaged by coming into contact with water.

Any leak may readily be detected by a strong odour.

Immediate notice is to be taken of this, and cases found damaged are to be thrown overboard.

(h) **Means of dropping Life Buoys.**—Several means have been devised of dropping life-buoys from the bridge, but at present a sentry is to be placed on the buoys, who would drop them when ordered or on seeing anybody fall overboard.

(i) In torpedo boats and destroyers, which do not carry the Service night life-buoys, a calcium light is to be attached as follows to an ordinary Kisbe life-buoy.

An ordinary calcium light, as supplied for the Service night life-buoy, is attached by a lanyard to a Kisbe life-buoy; another lanyard is fitted, having one end secured to the rail and the other attached to a screw eyebolt, which is screwed into the plug of the calcium light so that on throwing the buoy to a man the plug is automatically drawn and the calcium light actuated.

Screw eyebolts are supplied for fitting into plugs of the calcium light.

CHAPTER XIV.

MAGAZINE AND SHELL ROOMS.

The principal consideration in the design of magazines and shell rooms in H.M. ships is to ensure their immunity in action.

A magazine may be exploded either by a direct hit or by the flash of an enemy's shell reaching the magazine by way of the supply trunk. Such flash may be assisted and augmented by the ignition of charges in the handing room or in the course of supply.

While shell must be protected from a direct hit, the danger of their being ignited by flash is very remote. Consequently, apart from placing shell rooms below the waterline and away from the ship's side, their position is mainly governed by the convenience of supply.

Provision against Flash.

Provision against flash reaching the magazine is made in the form of:—

- (1) Armour protection to the gunhouse and trunk to keep out shells.
- (2) Flashtight arrangements in the gunhouse, working chamber and trunk.
- (3) Regulations limiting the number of charges in the course of supply at any moment, from the magazine to the guns.
- (4) The provision of handing rooms at the bottom of the trunk, separated from the magazine by flashtight bulkheads.

The first three do not come within the scope of this book.

Handing Rooms.—The handing room consists of a compartment built at the bottom of the ammunition hoist. In some cases (*e.g.*, 6-inch hoists in "Royal Sovereign" Class), there is an additional handing room at the top of the hoist.

In the case of power-worked mountings the handing room is protected from flash passing down past the gap between the revolving trunk and the fixed structure of the ship by leather aprons.

The doors through which ammunition is loaded into the cages of hoists are flashtight, so that flash can only pass at the moment when the charge is passing from the handing room into the cage.

Communication between the handing room and magazine is needed for access to the magazine and for the passage of charges during action. Separate arrangements are made for each purpose.

Access Doors.—These are usually of a standard type, 2 feet 6 inches by 2 feet 6 inches. They are strengthened with angle

irons. They open outwards from the magazine and are held when closed by four or six clips. These doors are not in themselves sufficient to keep out the flash of an explosion of a charge in the handing room. They are reinforced by a protective door made of thin plating placed outside the access door. This protective door also opens outwards, but, being larger than the access door, does not interfere with the latter.

Experiments have shown that these double doors will withstand the pressure resulting from the ignition of charges in the handing room.

In action both the doors are normally closed and are only to be used when the magazine crew are entering or leaving the magazine.

Flash Proof Scuttles.—Charges are supplied from the magazine through some form of scuttle.

In the case of power-worked mountings the scuttle consists of a revolving drum, pivoted on horizontal trunnions and built into an opening in the handing room bulkhead. A portion of the surface of the drum is cut away so that a charge can be inserted from the magazine side. The drum is then turned so that the opening is towards the handing room and the charge rolls out into a tray in the handing room.

The following diagrams explain the action. The fitting of the drum to the opening is very accurate and the scuttle provides complete obstruction to flash in all positions. (Plate 44.)

DIAGRAM SHOWING WORKING OF FLASHLIGHT SCUTTLE FOR TURRET HANDING ROOMS.

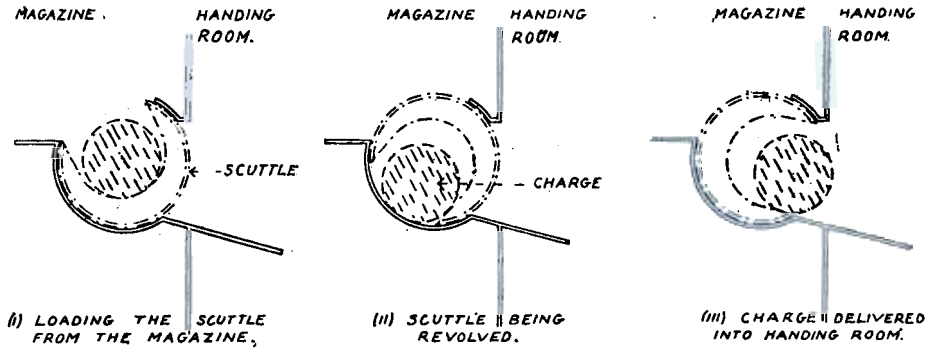

Charges for guns on handworked mountings have different types of scuttles adapted to take the charge in its Clarkson's case.

The type which has been adopted is known as the "flap" type. (Plate 45.) The scuttle is protected by a Fearnought screen, which, if space permits, is fitted on a "Penthouse" frame. In order to check any tendency of the scuttle to open and close as the ship rolls, the seating of the shutter is now set at an angle of 25° .

Face page 134.



FLASHLIGHT SCUTTLE FOR TURRET HANDING ROOMS.

Face page 135.

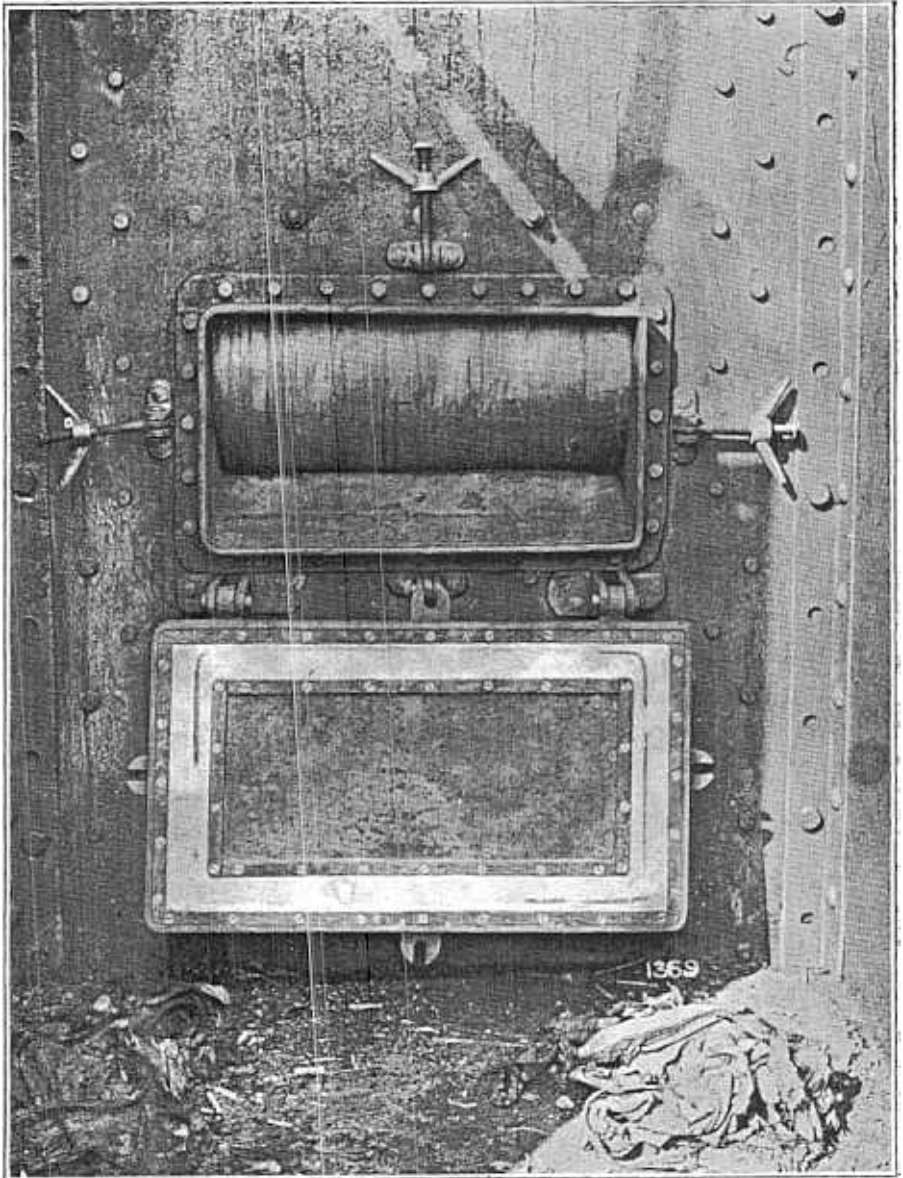

FLASHTIGHT SCUTTLE FOR TURRET HANDING ROOMS.

HANDING SCUTTLE. (FLAP TYPE.)

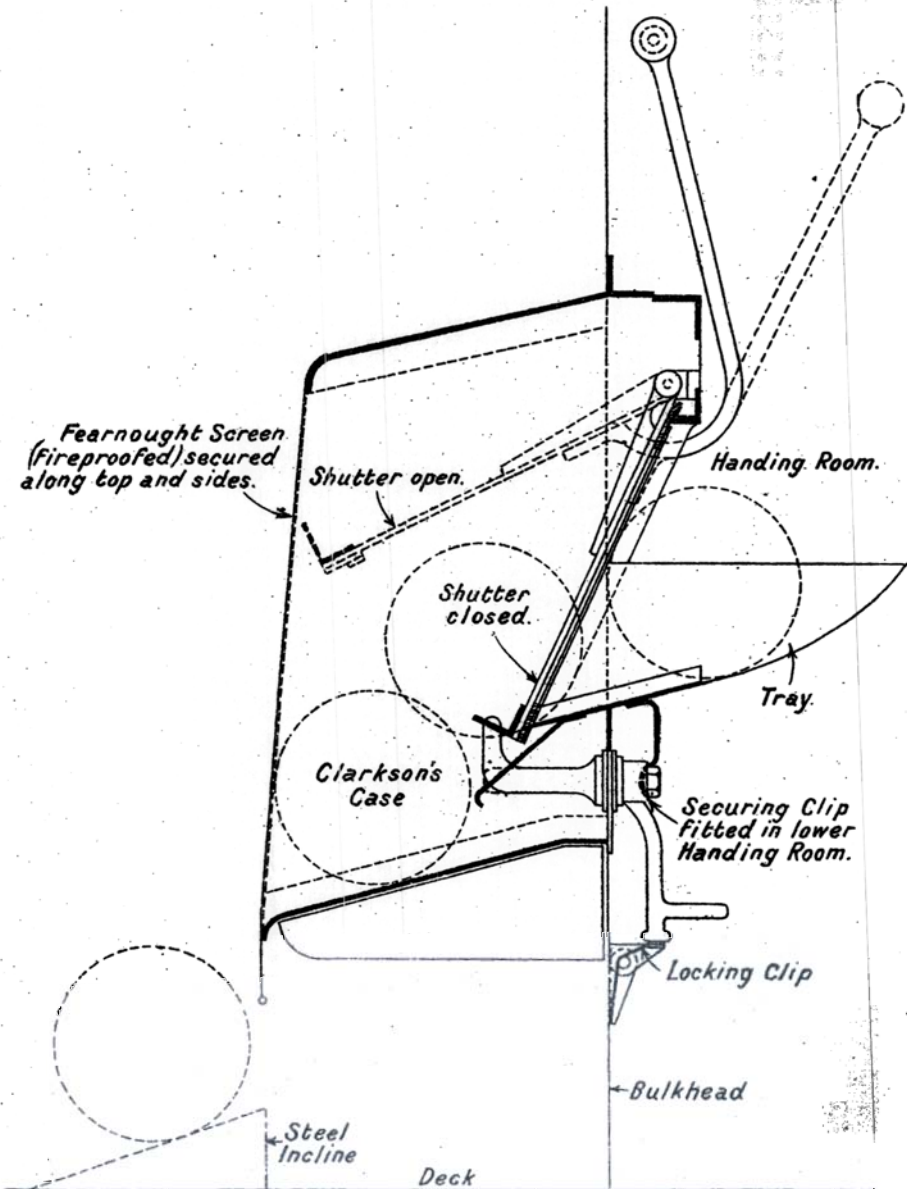

Face page 134.



"LUCK" SCUTTLE.

Face page 135.



"LUCK" SCUTTLE.

A new type of double-door scuttle known as the **Luck Scuttle** (Plate 46) has been fitted to the 7·5-inch handing rooms of "Effingham" Class, and some of the later light cruisers. This consists of a box, worked into the bulkhead, fitted with two doors. The doors are actuated by a cam arrangement, which prevents one being opened before the other is shut. The scuttle is therefore of the permanently closed type. The Clarkson's case is passed through horizontally and the action of the scuttle, which is automatic and very rapid, is shown in the plate. It is proposed to fit one scuttle for supply and a reverse one of the same type for the return of cases.

To avoid congestion in the ammunition hoists, separate return tubes, down which the empty cases are thrown, are fitted from the gun decks, the fall of the cases at the bottom being broken by fitting a canvas sleeve, which can be slightly triced up. In some cases these return tubes are led direct into the handing room, care being taken to keep the opening remote from the magazine hatch. In these cases a scuttle is fitted on the gun deck, worked by a pedal, and so arranged that it remains closed when not actually in use.

Importance of Venting.—It has been very definitely established by experiment that the explosive effect of a charge fired in the handing room is greatly reduced, provided suitable arrangements are made for the escape of the gases evolved.

In the case of an explosion in the handing room during action, the line of access hatches leading to the upper deck will lift under pressure from below, allowing the gases from the explosion to reach the open air. Such hatches should be closed by their ordinary clips, but on no account shored down.

Venting will also take place through the turret trunk, lookout ports and gun ports of the turret.

Shell Room Aprons.

As the handing room floor in all ships is merely a platform, which is not intended to be watertight, it is necessary to prevent the flash from an explosion in the turret, which passes down the trunk into the shell room, from getting into the handing room by way of the hatch or through the spaces between the revolving trunk and the fixed structure of the floor of the handing room. Arrangements have therefore been made to fit light flashtight hatches to the hatch openings, these hatches being fitted with through clips, so that they can be opened from either side, and flashtight leather aprons have been fitted round the revolving trunk on the handing room floor level; these prevent flash getting through the spaces between the revolving trunk and the fixed structure.

The hatches will vent upwards and the leather aprons either way in the event of an explosion in the handing room or shell room.

The following diagram illustrates a typical leather apron :—

LEATHER APRON, COVERING SPACE AROUND CENTRAL TRUNK BETWEEN SHELL ROOM AND HANDING ROOM OF 15-INCH GUNS.

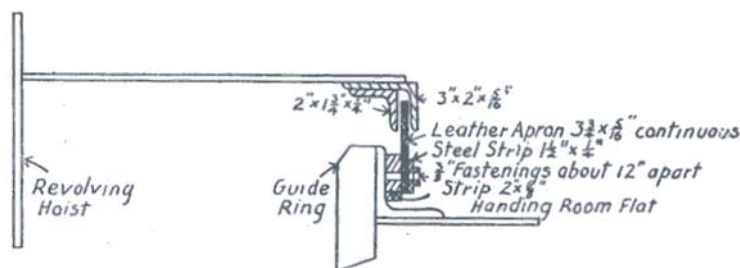

Spontaneous Ignition of a Charge in a Magazine.—In addition to these action considerations, provision must be made for the case of spontaneous ignition of a charge in the magazine during ordinary storage conditions.

The arrangements for weakening cases during storage with the object of confining such an explosion to one case have been explained in Chapter VIII. Unless some easy line of escape for the gases of the explosion be provided, further explosions may result from the heat and pressure.

The access doors, already described, provide suitable venting arrangements from the magazine into the handing room. Both the access door and the protective door open outwards and the clips securing them readily give to internal pressure. It is not, however, intended that the protective door should be closed except during action.

Further venting from the handing room to the open air is supplied by the line of access hatches and the supply trunk.

Flooding Arrangements.

Arrangements are fitted so that with the ship floating at the load waterline each magazine and in certain classes of ships each shell room can be flooded, in a time not exceeding 30 mins. in older ships and 15 mins. in the latest ships. These times are taken when the magazine is fully stowed.

For this purpose, as near to each magazine and shell room as is practicable, an inner flooding valve is fitted in communication with an outer flooding valve; in later ships the outer flooding valve is in direct communication with the sea, one outer valve supplying one or more inner valves; in older ships the outer valves are in communication with one of the seacocks. The seacocks should always be open, except when it is necessary to drain the piping for repairs.

As a rule, magazine flood valves are fitted to be operated from the handing room and from an upper position. In certain ships a third position below the armour deck is fitted.

"QUEEN ELIZABETH" CLASS. MAGAZINE FLOODING ARRANGEMENTS.

PART PROFILE

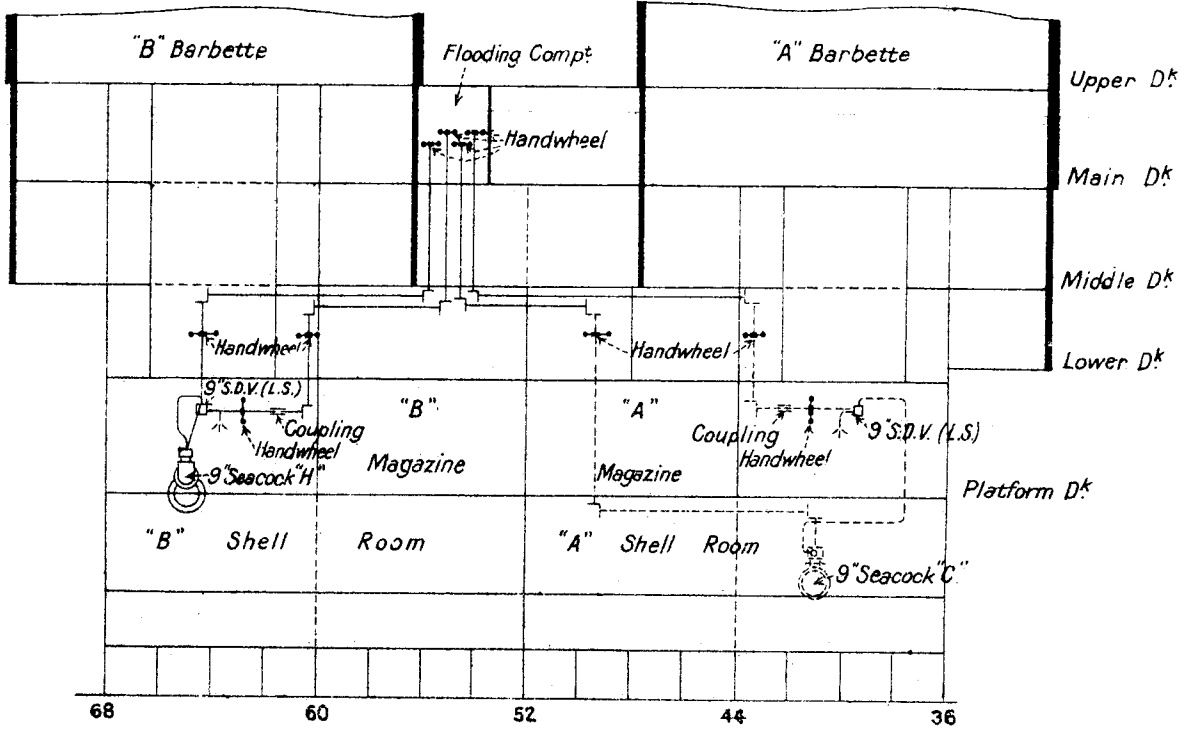

PLAN OF MAGAZINES.

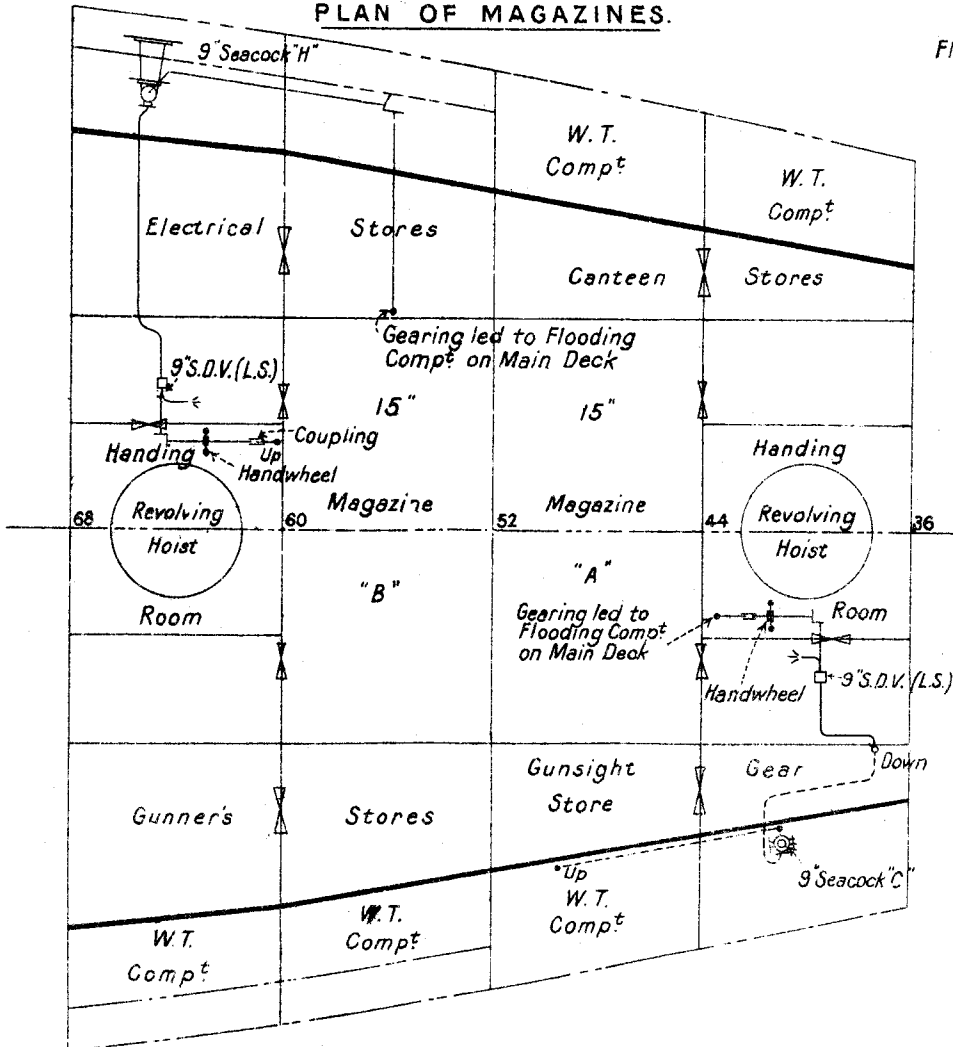

Flooding Pipes shown Red.

"CALEDON" CLASS. MAGAZINE FLOODING ARRANGEMENTS.

PART PROFILE.

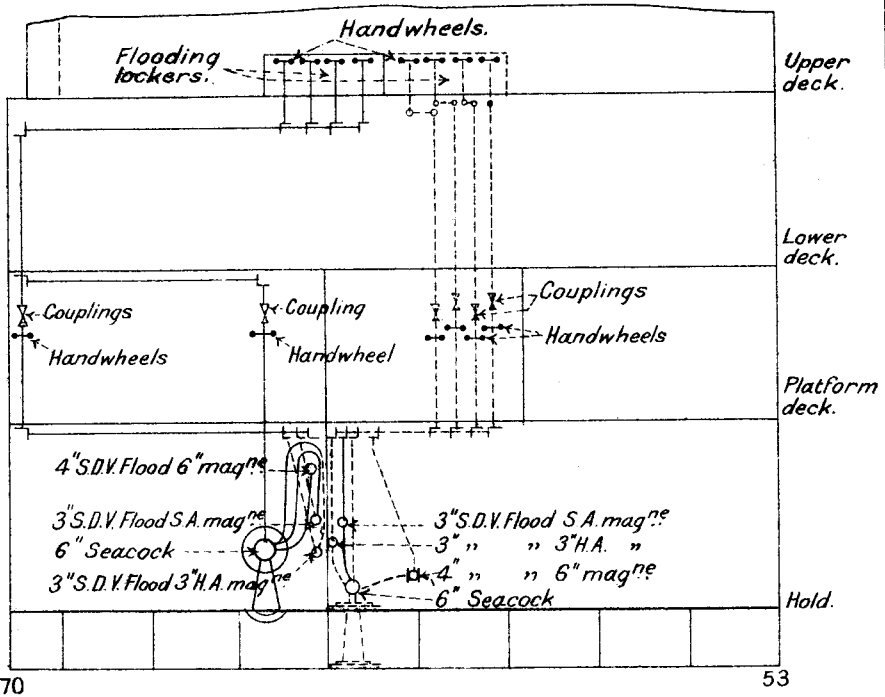

PLAN OF MAGAZINES.

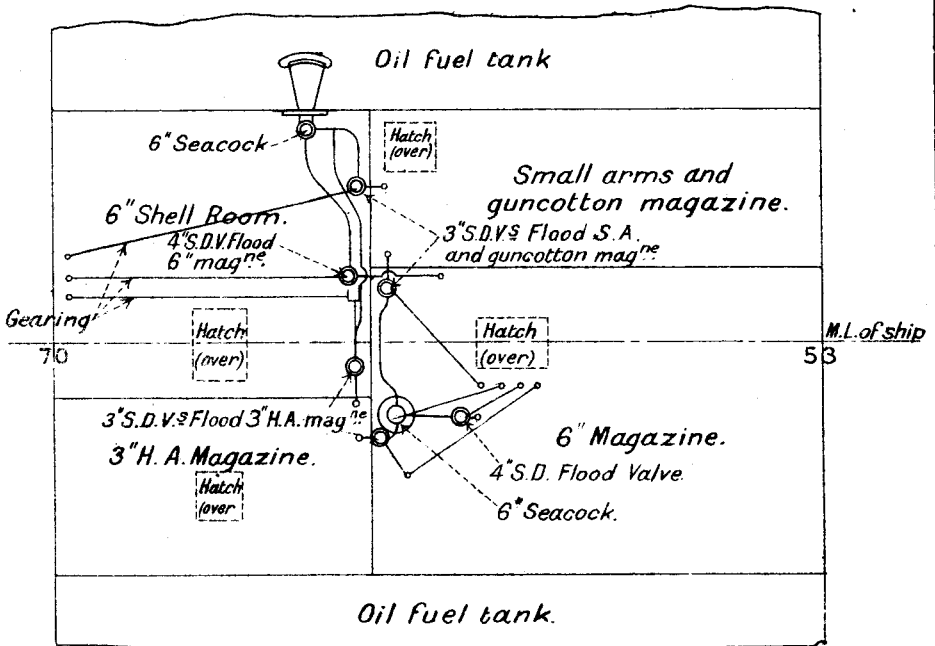

In heavy ships the upper position is on the main deck.

Plate 47 shows typical flooding arrangements for a battleship.

Plate 48 shows typical flooding arrangements for a light cruiser.

In the case of some of the light cruisers the shell rooms are fitted to flood from the mains through a hose connection in the crown of the shell room.

Flooding Cabinets.

In the latest ships the upper positions for working the flood valves are grouped together in a cabinet, in which the wheels for operating the valves are kept shipped. These wheels (and consequently the upper portion of the rod gear) are rigidly held by locking pins, which can only be removed by getting access to the cabinet. The cabinet, which can be reached either from the upper deck or main deck, is watertight, and is always kept locked except in action.

It is of the utmost importance that nothing should impede ready access at all times to the doors leading to these cabinets. This particularly applies to the access from the upper deck.

In light craft these cabinets are in the form of watertight lockers, situated on the upper deck.

In older ships the upper position consisted of a deck plate. The rod gear operating the valves terminates just below the deck. A large sized "T" spanner has to be inserted over a squared head to operate the rod gear.

The arrangement consists of a locking plate inserted over the end of the rod gear. When the plate is locked (which is done by a special key) the upper portion of the rod gear cannot be moved either from below or from above. The locking plate is covered by a protecting plate screwed into the deck socket.

To work the valve from such an upper position, the cover plate must be removed and the locking plate unlocked and withdrawn. The "T" shaped spanner is then fitted over the squared end of the rod gear and revolved.

An indicator plate, operated by a screw thread cut on the rod gear, shows when the rod gear is in the open or shut position.

The rod gear is also arranged so that it can be operated from a hand-wheel in a lower position. A coupling is fitted immediately above this hand-wheel. The coupling is held by a locked cotter.

The usual arrangement is that the same cotter pin is used to couple up the handwheel as to connect the upper and lower positions of the rod gear, and that when one is connected the other is disconnected.

From this it will be seen that when the cotter pin is in such a position as to connect the upper rod gear to the lower rod gear, the valves can only be operated from the upper position and that the whole system is held rigidly until the cabinet (or deck plate in older ships) has been unlocked. In case of emergency, should the upper position be unapproachable through fire, or unusable

through damage, the upper rod gear can be disconnected at the lower position and the valves operated from there.

Object of Locking.—Attention is called to the fact that the locking arrangements of this system are designed to guard against mistakes rather than evil intent, and that lengths of shafting can be disconnected elsewhere by removing tapered pins. The valves could then be operated by any form of pipe wrench that would grip the lower part of the rod gear.

Air Escape.—To allow the air to escape when flooding, a small air escape pipe is fitted to the crown of the magazine, leading to just below the upper deck; in order to prevent water finding its way below, these pipes terminate in a bend at the top, are perforated, and have their ends closed.

Dry Dock Flooding.—For flooding when in dry dock an adapter is supplied, which is fitted externally to the seacock and connections made to the shore water mains by means of hoses, the valves for flooding being worked as though the ship was afloat.

In older ships a special dry dock flooding pipe which joined the system between the inner and outer flooding valves was permanently fitted for similar connection with the shore; in this case the inner valve only had to be opened for flooding.

Draining.—Drains are usually fitted to shell rooms, but not to magazines; the latter must therefore be cleared of water, if flooded, by means of portable pumps or flexible leads off the main suction pipe, where so fitted.

In the case of turret mountings the handing and shell rooms must be regarded as one compartment from the flooding point of view, since they are connected by the revolving trunk.

Spraying Arrangements.

Spraying arrangements are fitted to the magazines of all capital ships and light cruisers. They provide a means of spraying the cases and certain bulkheads of the magazine from the fire main service system of the ship.

A branch is taken from the fire main service directly over the magazine. This branch is controlled by a valve which is normally locked "open." The pipe then leads directly to the spraying valve in the magazine. This valve admits water to a system of piping led over the ammunition cases, and along the bulkheads common with the handing room, and any other compartments where a fire may be generated. These pipes are either perforated or fitted with roses so as to distribute the water in the most efficient manner.

The spraying valve can be operated from either the magazine itself, the handing room, or, in the latest ships, the flooding cabinet. When it has been impossible to bring the rods close to the flooding cabinet, a separate spraying cabinet has been fitted.

The valve wheel in the cabinet can be locked by a pin, and as the rod gear can only be disconnected in the magazine itself,

provided the locking pin is in place, the valve can only be operated by unlocking the cabinet or magazine. In action the cabinet is unlocked and the pin is removed. The spraying gear can then be operated from any position.

The coupling in the magazine (where fitted) enables the valve to be opened from below if damage to the upper position has jammed the gear. It also enables men in the magazine to disconnect the upper rod gear and close the spraying valve, if it has been opened from the outside by mistake or unnecessarily.

The flooding gear, as well, will be arranged in a similar manner to the above in all new ships.

In order to provide a supply of salt water readily obtainable in a magazine, a branch is led off the spraying service above the spraying valve. This branch is controlled by a screw-down valve in the magazine and fitted to take a hose connection. This supplies a ready test for the system as far as the spraying valve.

Exposure to Enemy Fire.

The system, in that it is dependent on the fire main service of the ship, is partly above armour and liable to be put out of action by the enemy's fire. This disadvantage must be accepted, bearing in mind that the fire main service is the only system kept constantly under pressure and that the spraying arrangements are not solely for use in action, but that they may be needed at any moment in peace or war.

Magazines as a rule are not deep enough below the waterline to provide sufficient head of water to enable spraying to be carried out direct from the sea, though this has been fitted in some foreign ships.

Note.—The drenching system must not be confused with the spraying system. The former is supplied from the hydraulic pressure main of the ship and deals with the drenching of exposed charges in the working chamber and handing room only.

Ventilation and Cooling.

Cooling apparatus is fitted in all heavy ships and light cruisers, also in sloops which may be employed abroad.

Supply trunks lead from the weather decks to the magazine exhaust trunks from either the weather or main decks.

When the cooling apparatus is not in use, a fan sucks the air from the weather-deck down the trunk and through the cooler to the magazine.

When the cooler is in use, the supply and exhaust valves leading to the weather or main decks are closed, and the course of air is changed in the exhaust by means of a flap valve, so that the fan draws the air from the magazine exhaust and delivers it through the cooling tank and back to the magazine.

In ships where no cooler is fitted, the supply fan draws direct from the supply shaft and forces air into the magazine. The air escapes by means of the exhaust shaft.

Plate 49 shows typical arrangement for battleships and Plate 50 for light cruisers.

Notes on Ventilating Arrangements.—The important points to be remembered in ventilating a magazine are :—

(1) That unless the air which is pumped in is cooler and drier than the magazine itself, the tendency will be to increase the damp rather than to dry it up.

(2) That the air pumped in should be as dry as possible. The air on deck may be considered dry when the wet and dry bulb thermometers differ by not less than 5°.

Therefore, the cool of the day, when the magazine will be warmer than the outside air, is a good time for ventilating, also when the magazine is especially hot owing to steam being up; when, however, the outside air is very dry, as may frequently be the case during the summer, the magazine may be ventilated with advantage, although its temperature may be below that of the outside air.

The magazines may need a good deal of drying after men have been at work in them, as in taking in ammunition; also when a magazine has cooled down after being heated, owing to steam trials, &c., the air is likely to become damp, and a favourable opportunity should be seized to dry the air again.

The above remarks, which are especially applicable to magazines not fitted with cooling apparatus, apply in certain circumstances to magazines which are so fitted.

Ventilating arrangements, both supply and exhaust, are provided for all magazines and shell rooms, the fans drawing fresh air from the open.

The ends of the supply and exhaust pipes are covered with wire netting, to which attention is required, in order that the ventilation may not be obstructed by the presence of dust; the netting is fitted so as to be removable, and this should frequently be done and the wire netting cleaned. These ends also have watertight valves. Watertight valves are also fitted where the supply and exhaust trunks pass through the protective deck.

In the case of magazines fitted with cooling apparatus the supply and exhaust valves are geared off one rod, where possible, and are protected by perforated brass coverings, which are to be kept clean and bright, and are never to be painted.

The wheels for working the air supply and exhaust valves are fitted outside the magazines, in order that they may be operated without opening the doors. Plates giving instruction as to the working of ventilation and magazine cooling valves are fitted near the positions from which these valves are controlled.

Ventilating valves of magazines and shell rooms should be kept closed when not in use.

In the case of magazines to which cooling apparatus is fitted, the same fan is used for circulating cooled air or blowing in fresh air (see Plates 49 and 50). The valves in the exhaust to the open,

"QUEEN ELIZABETH" CLASS. MAGAZINE VENTILATING AND COOLING.

PART PROFILE

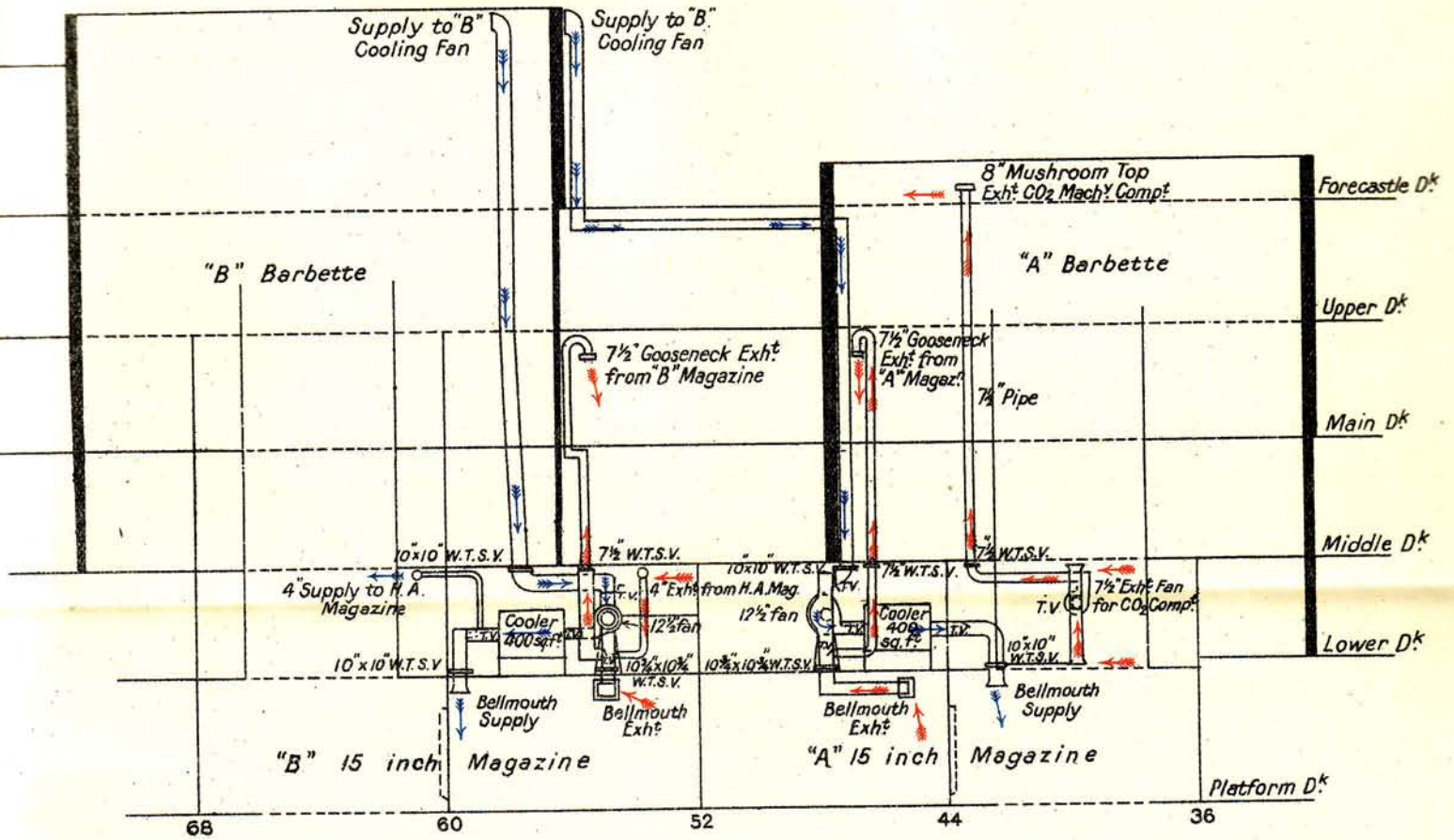

PART PLAN OF LOWER DECK.

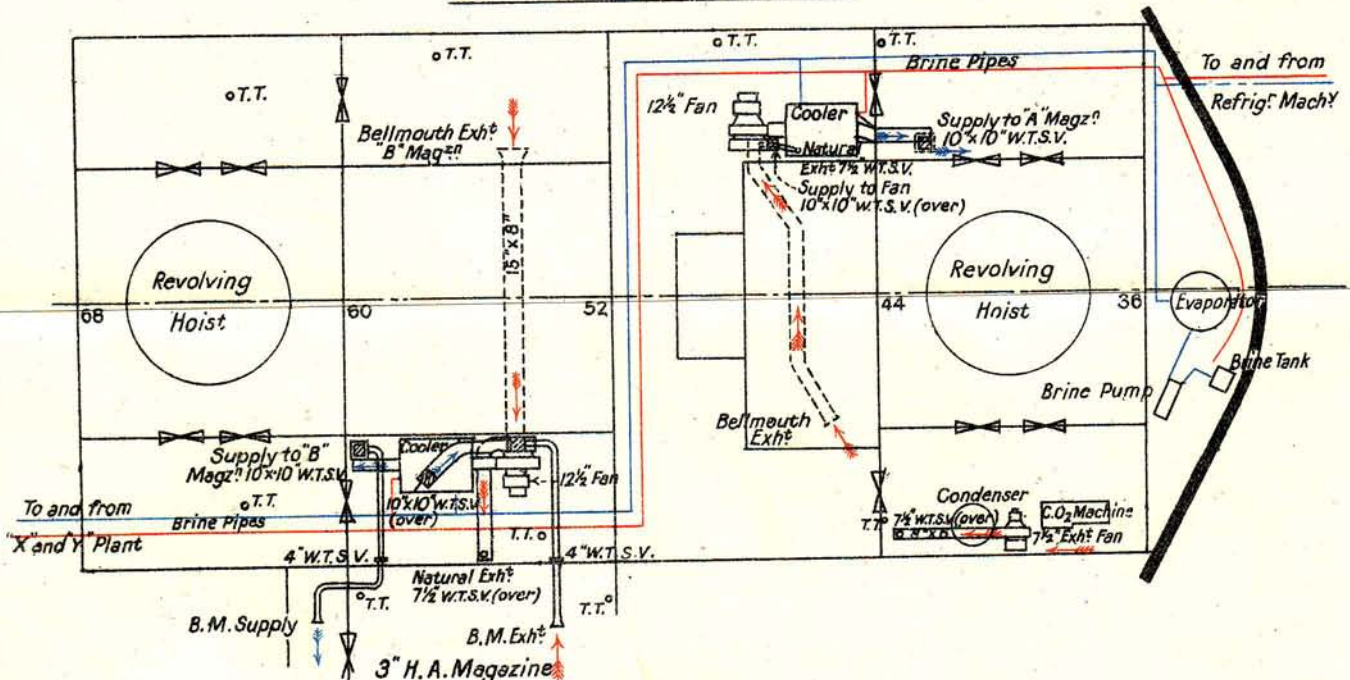

CALEDON CLASS. MAGAZINE VENTILATING AND COOLING.

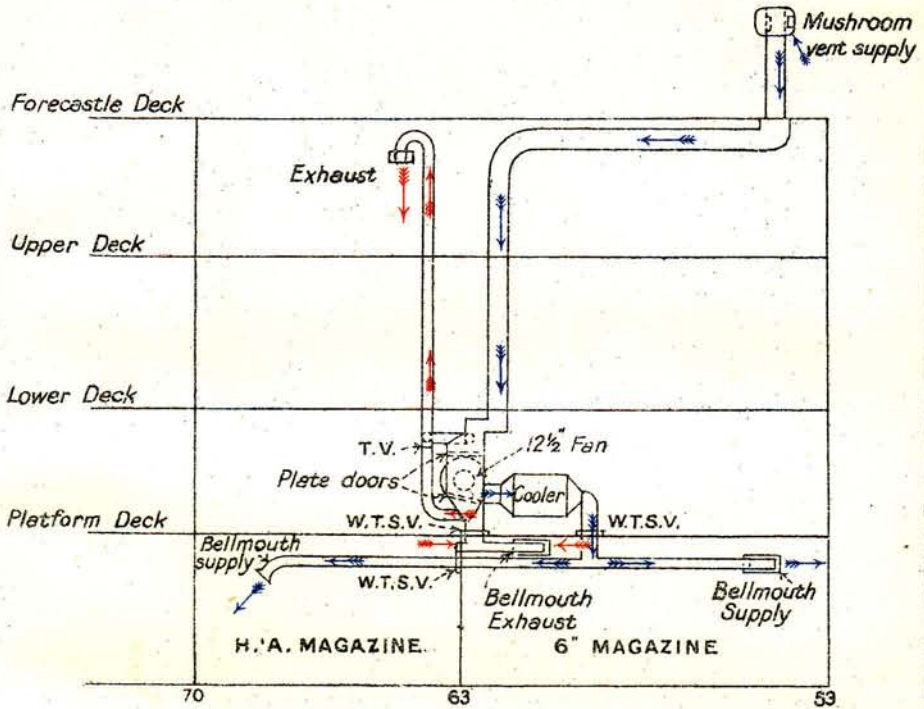

W.T.S.V. Watertight slide valve.
T.V. Throttle valve.
T.T. Temperature tube.

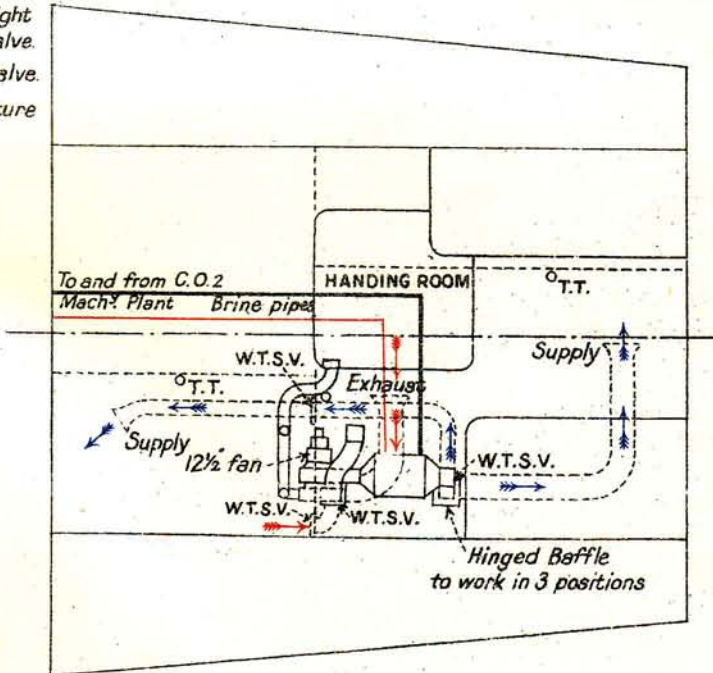

PART PLAN OF PLATFORM DECK.

CALEDON CLASS. MAGAZINE VENTILATING AND COOLING.

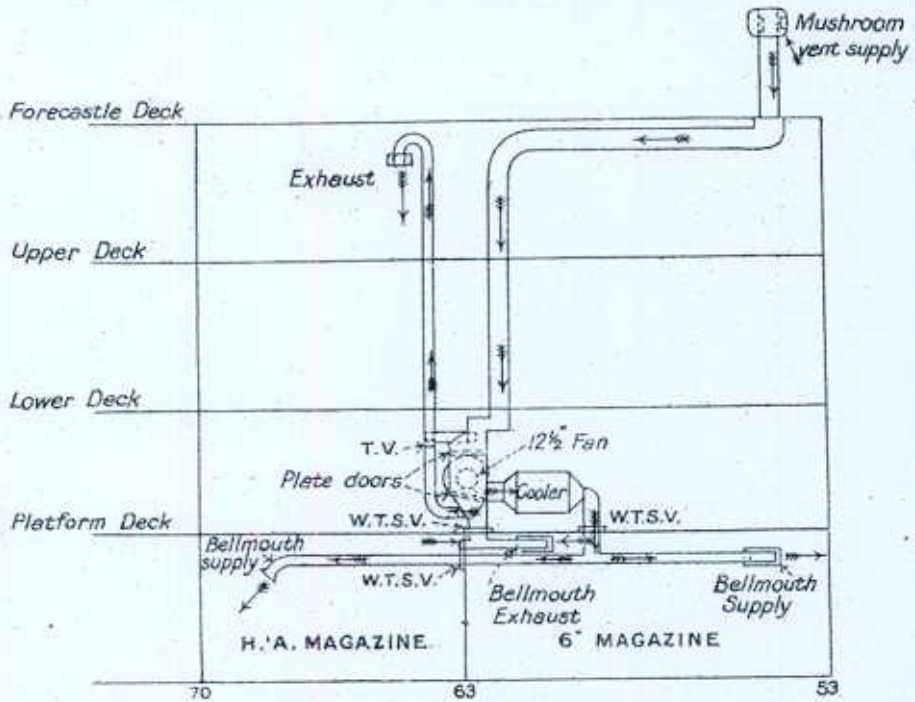

W.T.S.V. Watertight slide valve.
T.V. Throttle valve.
T.T. Temperature tube.

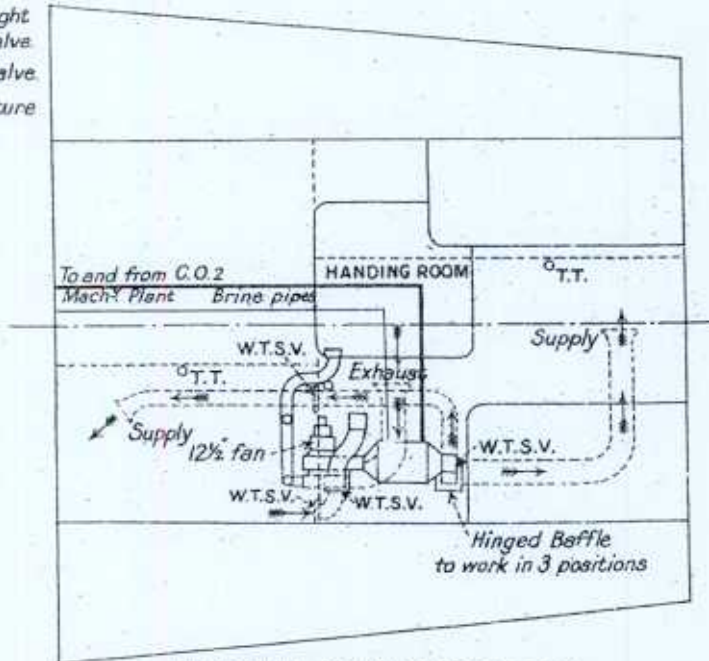

PART PLAN OF PLATFORM DECK.

and in the supply from the atmosphere, are closed when cooling apparatus is at work.

In shell rooms special exhaust pipes are generally not fitted, the hatches and revolving hoist forming the exhaust.

Cooling Arrangements for Magazines.

Machinery is fitted for the purpose of cooling brine; this machinery is steam driven in the older ships and electrically driven in all the later ships. As a general rule the machines are of the carbonic anhydride type, placed under protection where possible, but in the smaller classes of vessels machines of ammonia anhydride type are used, placed on the weather deck. The latter type is more efficient, but cannot be placed below decks on account of the dangerous nature of the gas.

Instructions for working the machines are supplied by the maker with the machinery, and should be carefully adhered to.

General Description.—The following is a general description of the method by which magazines are cooled.

The method adopted is to cut off the ordinary ventilation to the magazine, and by means of a fan to circulate artificially cooled air through it.

The cooling process is based on the fact that substances such as carbon dioxide (CO_2) or ammonia (NH_3) in passing from a liquid to a gaseous state absorb heat.

Circulation of CO_2 or NH_3 .—The CO_2 or NH_3 is circulated by the compressing machine through two sets of coils in two separate tanks, *i.e.*, the condenser and the evaporator. From the compressor the CO_2 or NH_3 passes, at a temperature higher than sea water, into the condenser. The condenser tank contains a series of coils, copper in the case of CO_2 and wrought iron or steel in the case of NH_3 , through which the CO_2 or NH_3 passes, and in which it is cooled and assumes the liquid condition. The actual removal of heat out of the ship takes place in the sea water circulating through the condenser.

The CO_2 or NH_3 leaves the condenser in liquid form and passes through the regulating or expansion valve to the evaporator, where the pressure is released; on being relieved of pressure it returns to its gaseous state, the amount of heat being withdrawn during this change being sufficient to cool the CO_2 or NH_3 to the evaporator temperature, and also to cool the surrounding brine which has been heated by contact with the air from the magazine.

From the evaporator the gas is returned to the compressor, in which the pressure and temperature are raised before entering the condenser; on its way to the latter it passes through a separator to clear it of oil and other foreign matter.

From the condenser it is again admitted to the evaporator, where it returns to its gaseous state and the above cycle is repeated.

The carbon dioxide and anhydrous ammonia in liquid form are supplied in flasks, from which the charge in the system is replenished from time to time.

Circulation of Brine.—The brine consist of fresh water and calcium chloride, as this solution can be made with a very low freezing point, and causes the least rapid deterioration of the pipes and coils.

The brine pump draws the brine from the evaporator, where the expanding CO_2 or NH_3 has cooled it, and discharges it through the tubes of the air-cooling tank and back to the evaporator. The air cooler is similar to a marine condenser, the brine flowing through the tubes at a temperature of not less than 34°F . and the air circulating around them. Each cooling tank is fitted with a tap for drawing off condensed moisture from the air side of tubes, and a save-all for collecting this drainage, which should be thrown overboard and not allowed to pass into the bilges.

When several cooling tanks are fitted in connection with one machine, the brine is apt to find its way more readily through one tank than through the others; in this case the temperatures of brine and air must be carefully observed, and any such action rectified by the proper manipulation of the brine valves. In some cases, where one magazine is much more difficult to cool than another, it will be necessary at times partly or completely to close the brine cocks at some of the cooling tanks in order to circulate the brine more rapidly, where the cooling effect is most required. Every effort must be made to discover the best means of regulating the brine and cold air supply, so as to keep all the magazines at as even a temperature as possible.

Circulation of Air.—The ordinary ventilation being suspended, a fan now circulates the air through the magazine and cooling tank on "closed circuit." The air is delivered in the upper part of the magazine in a horizontal direction or slightly inclined towards the floor, and to permit of free circulation a 3-inch clearance is allowed between the cartridge cases and the bulkheads and floors. When actually stowing the magazines care should be taken to leave plenty of room near the inlets and outlets for the cold air to move freely.

Arrangements are provided so that, if desired, the cooling effect can be concentrated on any one magazine in a group of magazines connected to the same cooling system.

Danger of CO_2 .— CO_2 is a colourless gas considerably heavier than air, and, being irrespirable, accumulations of it in mines and other places have been the cause of numberless fatal accidents.

The CO_2 machines are therefore placed in separate, well-ventilated compartments, as far as possible from sleeping quarters, and exhaust fans are used to remove any small leakage of gas.

The bulkheads are not perforated for a height of 12 inches from the deck, and the sill of the door is carried up a similar amount.

A candle lamp is always kept burning below this level so that it would give warning of any considerable leakage by the flame becoming small or being extinguished.

The ammonia apparatus is invariably fitted above the upper deck on account of the extremely dangerous nature of the gas. Each apparatus is fitted with drenching arrangements to enable the cylinders of the compressor and all valves and joints, *i.e.*, places where leakage might occur, to be drenched with water, which has a strong affinity for the ammonia. This prevents the gas spreading to a very large extent. The drenching apparatus can be worked from outside the machinery room as well as inside.

Storage of Flasks.—It is undesirable to expose the flasks containing CO_2 or NH_3 to a temperature exceeding 90°F ., and if the temperature of the storage position exceeds this, arrangements should be made for stowing flasks in a tank of water.

Notes on Use of Apparatus.—When magazine cooling arrangements are in use, all valves and doors not necessarily open should be completely closed. In ships which have handing rooms to the magazines, the handing room doors and scuttles should be closed and the handing rooms should be ventilated to keep them as cool as possible.

Magazines should not be opened unnecessarily, as trials have shown that the temperature of the air in a magazine being cooled will rise appreciably should the door or scuttle be opened for a few seconds even.

When the cooling operations are suspended, particular care is to be exercised that all slide valves, &c., are properly closed.

The temperature to which brine should be cooled depends upon the temperatures of the magazines, sea water and air prevailing at the time, but the temperature should not be allowed to fall below 34°F .

The success of the installation in reducing the magazine temperatures must depend to a great extent on the temperature of the brine, and also on the amount circulated. To ensure the best possible results the brine in circulation should be reduced to a low temperature before starting the fans, and whilst the fans are running, this temperature should be maintained as near as possible, while the quantity of brine circulated is kept as large as possible. A temperature of brine of about 34°F . at the evaporator, with a difference of two or three degrees between the brine inlets and outlets at the evaporator, appears to give good results in temperate regions. In tropical regions it is probable that a higher mean temperature must be accepted, but the difference between the temperatures at the brine inlet and outlet at the evaporator should be kept as small as possible by maintaining a rapid brine circulation.

When working the installation for short periods daily, it is found best to continue to run brine pumps and fans after the engine is stopped and until the brine has warmed up.

In ordinary working, valves on the air trunks should be so worked as to distribute the cold air in the right proportions to each magazine. Experience is required in order to determine this.

Arrangements are made for replenishing the air in the magazines as required. In some of the older ships the present air supply and exhaust arrangements remain, but in new ships, and others where practicable, the fresh air is supplied either through the cooling tanks or passed directly into the magazines by means of bypasses on the cooling tanks.

When men are at work in magazines, the cooling arrangements may be worked as desired at the discretion of the Commanding Officer, and in these circumstances fresh air may be drawn from the weather deck or the air may be returned from the magazines, but, in either case, the water condensed at the cooling tank may be considerably increased, and water so condensed should be drawn off and thrown overboard without entering any of the drainage systems of the ship.

When ventilating magazines, which are colder than the open air, the brine should be cooled and circulated, and the fresh air should be passed through the cooling system to cool and dry it. There should then be no sweating in the magazines.

Temperature Tubes. (Plates 51 and 52.)

Temperature tubes are provided to take the temperatures of a magazine without opening the access doors.

The tubes lead in amongst the ammunition cases stowed in the bays. The bottom of the tube is closed. The thermometer hangs in the tube, 18 inches below the level of the top of the magazine, and is suspended by a chain. The chain is attached to a lock, which fits in the upper end of the tube and when locked in place completely blocks the tube.

A protecting plate screws over the upper end of the tube and is fitted with locking arrangements.

The upper end of the tube is flush with the deck and is situated directly over the magazine on a deck convenient to access.

LOCKING ARRANGEMENT FOR TEMPERATURE TUBES, (OLD TYPE).

LOCK SHOWN IN RED.

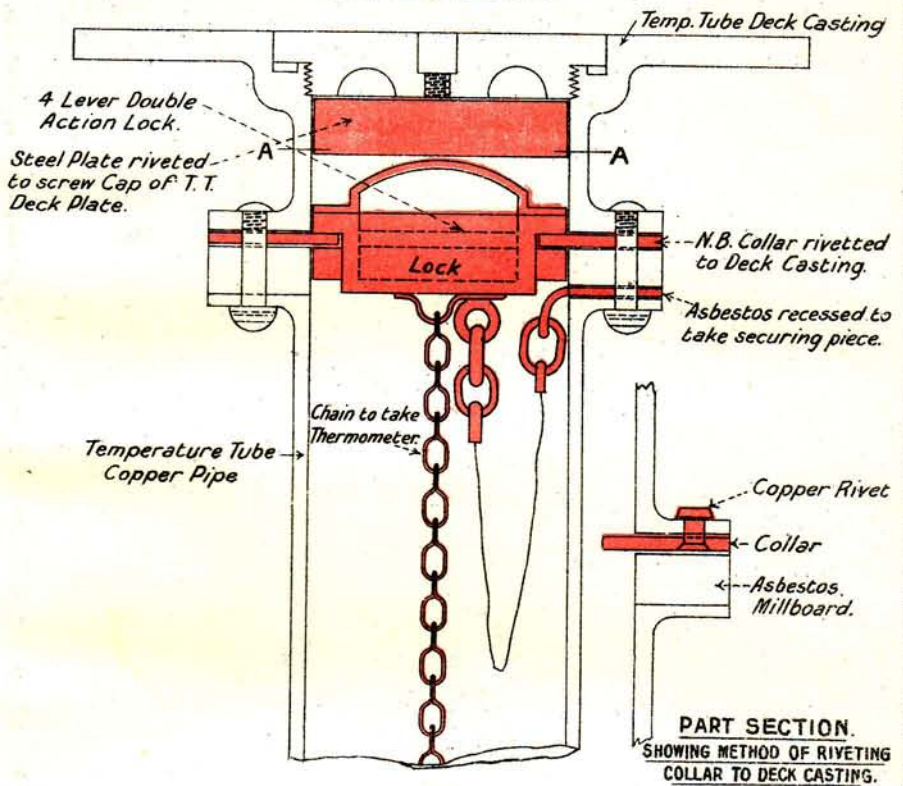

ELEVATION.

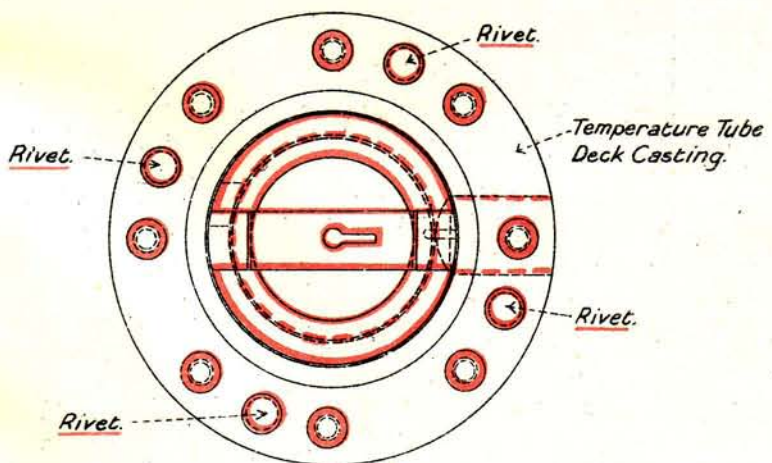

PLAN AT A.A.

LOCKING ARRANGEMENT FOR TEMPERATURE TUBE (NEW TYPE).

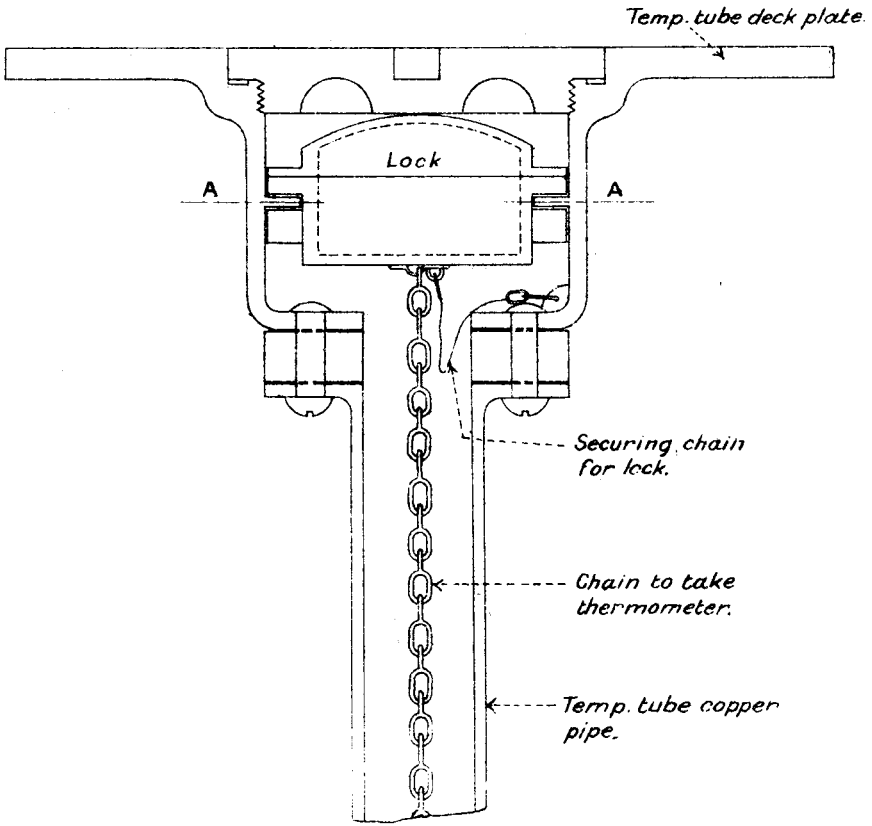

PLAN AT A. A.

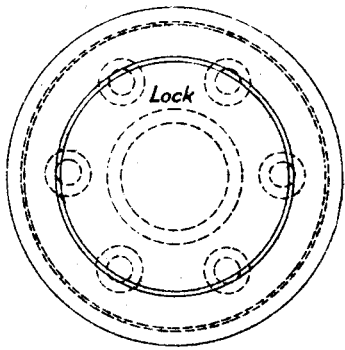

CHAPTER XV.

BOOKS AND FORMS USED IN CONNECTION WITH NAVAL
AMMUNITION.

Ordnance Stores.

Ammunition forms a section of the ordnance stores in charge of the gunner of a ship. Consequently the notes that follow apply to ammunition as well as other ordnance store articles.

Warrant S. 1411.—This is received on board on commissioning from the A.S.O. It is a full list of the principal ordnance stores which should be carried in the ship. It includes ammunition of all kinds.

This warrant should be corrected by the gunner of the ship in accordance with any alterations authorised by Admiralty Orders.

Ordnance Ledger.—This is issued to the ship on commissioning from the A.S.O. with the establishment filled in.

A column with printed headline is given for each particular form of store.

Issues made to the ship by the gunner should be entered from the expense book every quarter. Issues to other ships and returns to the Armament Supply Depôt (which are not shown in the expense book) should be entered as they occur. Receipts should always be entered immediately the notes are received.

Complete instructions for accounting for Ordnance Stores are given in the beginning of the book.

Expense Book, S. 1418.—This is used to record expenditure of the current quarter. Expenditure should be entered daily. The total expenditure for each quarter should be transferred to the Ordnance Ledger at the end of each quarter.

Complete instructions for keeping this book are given on the first page.

Demands S. 1403.—These are made out in triplicate giving full details. The original and duplicate copies are sent to the armament supply depôt. The triplicate copy is retained in the ship for reference in case of loss of the originals.

Armament Supply Depôt supplies the stores accompanied by two S.1401 forms; of these one is given back to the armament supply depôt signed as a receipt, the other is retained on board in the guard book for supply vouchers.

No two sections of stores are to be entered on the same demand.

Returns and Issues S. 1401.—All returns and issues to other establishments or ships are made out in triplicate on form S.1401, the copies being dealt with as follows :—

The original and duplicate are signed and sent with the stores. The triplicate is kept in the ship for reference. One copy is returned to the ship signed by the receiving officer. This is kept in the guard book supplied for receipt notes.

All vouchers are to be numbered in sequence, dated and entered in the column provided in the ordnance ledger.

No two sections of stores are to be entered on the same return and issue note.

Landing of Shell for examination, S. 1146 and S. 1146A.—Instructions will be found on the form and in the Naval Magazine and Explosives Regulations.

S.—301. (Established—January, 1908.)

(This Form is to be placed with the Ship's Copy of Abstract in support of Expenditure of Ammunition.

H.M.S.....

EXPENDITURE OF .303-IN., PISTOL, AND AIMING TUBE AMMUNITION.

Name of Officer (or Petty Officer) in charge of Practice.

Description of Cartridges.	Number Issued.	Number Expended.	Number of Men.	Number of Rounds per Man.
Cartridges :—				
S.A. Ball, .303-in.				
Pistol, Webley				
S.A. Blank, .303-in.				
Aiming Tube				
Date of issue	Certified that the Ammunition stated above has been expended.			
Signature of Accounting Officer				Signature of Officer (or P.O.) in charge of Practice

The Accounting Officer is to see that the balance of unexpended ammunition is returned to his charge, and that fired cases up to fullest extent practicable, having regard to the nature of practice, are also returned.

Forms used in connection with Cordite.

These forms giving information are used when dealing with cordite, in addition to the ordinary forms and books used with other ordnance stores.

Cordite Records. S. 1147 and S. 1431.—These are for keeping cordite records on board ship. The directions for use are printed on the cover.

A specimen of S. 1147 (Cordite Records) is pasted on the inside as a guide to uniform method of keeping the records.

It is important that the record should be corrected on every occasion of receipt, issue or expenditure of cordite, information being taken from form S.1424 (late 0-130).

All forms S. 1424 and the ship's copy of S. 1429(a) are to be filed for record in the space provided in the portfolio.

Form S. 1147a. Special return of Magazine Temperatures.—Full instructions for rendering will be found on the form and in the Naval Cordite Regulations.

Form S. 1424. List of Lot Numbers, &c.—Whenever supplies of cordite are received on board the details will be found on form 0-130 which should accompany or precede the supplies. These details should be entered in the Cordite Records by the Accounting Officer.

Form S. 1429(a). Cordite landed for Examination.—Full instructions for the use of this form are shown on the cover. The form gives full particulars of cartridges and the result of examination.

One copy is retained on board for reference.

S.—1147. (Inside.) (Revised—January, 1917.)

(Specimen Form

H.M.S. "....."

*Adjusted or do not require adjustment

Lot *W.A. 2567*. Size *19*. Manufacture } *2/14*. Nature of } *6" B.L. 27½ lbs.*
 Date of }
 Cartridge }

* Strike out as necessary.

For use with Q.F. or composite Cartridges only. Lot No. of cordite cylinder or Batch No. of size 3½ cordite.†	Where stored.		Transactions.				No. of Cartridges remaining.	Authority for Inspection.	Result of Test.		REMARKS. (Magazine from which Cartridges for inspection are taken to be shown here.)
	Magazine.	No. of Cartridges in each. (To be shown in pencil and amended as necessary.)	Date.	Receipts and Issues.	No. of Cartridges.				Heat.	S.V.	
					Received.	Issued.					
X	90				150						
		31/3/14	From Priddy's Hard.								
		20/5/14	Gunlayer's Test		10						
		10/6/14	Battle Practice		50						
		15/9/17	To Bull Point		4						X
		3/10/17	From Bull Point			4					
						90					

† Allow a number of lines for each Lot or Batch.

G. 17215/12. G. 31286/16.

Sta. 604a/16. Sta. 94/18.

No. of Sheet 14.

S. 1147A.
O. 68.

Ship or Depot
Station
Date

RETURN OF TEMPERATURES OF STORAGE OF CORDITE FOR { YEAR } *ENDING { QUARTER }
Number of weeks during which the "average" of maximum daily temperatures for week has been between: ---

Magazines or other compartments in which cartridges for 1-pdr. guns or above are stowed.	Number of weeks during which the "average" of maximum daily temperatures for week has been between: ---					Above 120. See Note (ii).		
	80·1-85.	85·1-90.	90·1-95.	95·1-100.	100·1-105.		105·1-110.	110·1-115.

NOTE (i) To be rendered on 1st January in the case of annual returns, on 1st day of each quarter in the case of quarterly returns, and on paying off.
(ii) Special reports are to be rendered giving full details in cases where temperatures in excess of 120° F. are experienced.
(iii) Information as to temperatures is only to be inserted for the period covered by the return. * Rule through whichever word is inapplicable.

LOT NUMBERS OF ALL LOTS STOWED IN EACH OF THE MAGAZINES NAMED IN THE RETURN.

Mag.				Mag.				Mag.			
Lot Nos.	No. of Packages of each Lot.	M.D., M.C., or Mark I.	Date of Receipt on Board.	Lot Nos.	No. of Packages of each Lot.	M.D., M.C., or Mark I.	Date of Receipt on Board.	Lot Nos.	No. of Packages of each Lot.	M.D., M.C., or Mark I.	Date of Receipt on Board.

G. Officer.
Captain.

O.—130. (Revised—October, 1916.)
S.—1424.

LIST SHEWING THE LOT AND BATCH NUMBERS OF CORDITE CONTAINED IN B.L. AND Q.F. CARTRIDGES
(3-PR. AND ABOVE).

{ issued to H.M.S..... from } Armament Supply Depot at
{ returned from H.M.S.... } on..... 19.....

Nature of Ammunition.	Number of Cartridges.	Received. †		Cordite.			For use between Depôts only.				REMARKS.		
		Date.	From whence.	Size.	Initials and Lot or Batch Nos.	Date of Manufacture.	Grade.	Last Test.		Sentencing test when below 8'.			
								Result.	Date.	Result.		Date.	

NOTE.—Where "Batch" number of cordite in composite cartridges is known particulars are to be shown hereon.
* Strike out as necessary.
† This information is to be filled in by H.M. Ships.

Signature.....
Date.....

(This page shows outside of Form S. 1429(a)).

S. 1429(a). (Established—September, 1916.)

Erase the
two not
applicable. { ORIGINAL.
DUPLICATE.
TRIPLICATE.

**CORDITE LANDED FOR EXAMINATION AND
TESTING from H.M.S.**

This return is to be forwarded, in triplicate, to the A.S.O. when cordite is landed from H.M. Ships for examination and testing, as laid down in the Naval Cordite Regulations.

The columns 1 to 13 and 18 are to be filled in on board the ship. Column 21 need only be filled in when cartridges are landed for biennial or quadrennial examination.

After inspection the remaining columns will be filled in by the Inspecting Officer, and two copies of the form will be returned to the Commanding Officer of the ship, one for retention on board, and one for transmission, through the Commander-in-Chief, to the Admiralty. The other copy is to be retained by the A.S.O. for future reference.

(This page shows inside of Form S. 1429 (a)).

CORDITE LANDED FROM H.M.S. FOR EXAMINATION.

Authority for test..... Date of Landing.....19 ..

MAGAZINES.	TEMPERATURES DURING PERIOD THAT CARTRIDGES HAVE BEEN ON BOARD.		PARTICULARS OF CARTRIDGES LANDED FOR INSPECTION.					CONDITION OF CORDITE.					Date of Biennial or Quadrennial Examination.		REMARKS AND RECOMMENDATIONS.								
	No. of weeks since last annual landing of supplies for test that the average maximum daily temperatures for Cordite the week of this magazine have been above	No. of days (not necessarily consecutive) on which maximum temperature has reached	Nature and number of rounds remaining on board.	Date of first receipt on board.	Num-ber landed.	Size of Cartridges.	No. of Lot and Manu- facturer's Initials (see note).	Made up.	Result of Heat test and S.V. test (if taken).	Date of test.	Appar-ance.	Current.	Last year.	Current.		Last.	Sem- tence.						
1	80° F.	85° F.	4	5	6	7	8	9	10	11	12	13	14	15	16	17	18	19	20	21	22	23	Batch No. of Heat Test Papers used.

NOTE.—In the case of composite charges the lot No. of size 3½ is also to be given.

Signature of Captain of Ship

Signature of Armament Supply Officer receiving Cordite

Signature of Inspecting Officer

TABLE 1.

Explosives employed in the Naval Service, excluding Special Firework and Signal Compositions.

A.—Gunpowder.

Nature of Powder.	Where used.	Remarks.
E.X.E.	Cartridges, Impulse, Torpedo	The only form of moulded powder still remaining. Will probably be replaced by cordite.
Pebble -	Shell filling for C.P., C.P.C. and C.N.F. shell. (C.N.F. — Common Nose Fuzed.)	May be replaced by H.E. (shellite) in some shells.
R.L.G. ² -	Cartridges, impulse, torpedo -	Used mixed with pebble
L.G. (blank)	Blank ammunition - - -	
R.F.G. ² -	Bursting for shrapnel, igniters of cordite cartridges, signal cartridges, 1-inch aiming, percussion primers, tube pellets.	
Mealed powder	S.A.A., delay fuzes, primers, pyrotechnics.	
Pistol powder - Time compositions.	Fuzes, 1-inch aiming, tubes - Time rings of T. & T. & P fuzes.	

Note.—It is under consideration to do away with all different specifications for powder and use one composition for all, merely varying the dimensions of the grain, except for delay pellets and time compositions.

Table 1—contd

B.—High Explosives.

Nature of Explosive.	Where used.	Remarks.
Nitroglycerine Gun cotton	As a constituent of cordite - As a constituent of cordite. Demolition charges, &c.	For demolition charges usually wet guncotton is used, "primed" with dry guncotton. Lyddite is also called picric acid.
Lyddite -	Filling for H.E. shells - - -	
Shellite -	Filling shells - - -	A mixture of T.N.T. and ammonium nitrate. "Composition exploding."
Picric powder	Exploders for priming H.E. shells.	
T.N.T. (trotyl or trinitrotoluene).	Filling for H.E. shells, torpedo heads, &c., and as a constituent of amatol exploders for H.E. shells.	
Ammonium nitrate.	A constituent of amatol -	
Amatol -	Filling bombs, stick bombs, depth charges, mines, &c.	
C.E. -	Filling magazines of detonating fuzes and gages—primers for mines, depth charges, &c., and exploders for shells filled T.N.T.	
Mercury fulminate. Cap composition	Detonators and caps - - Igniferous caps and "detonators."	

C.—Propellants.

Nature of Propellant.	Where used.	Remarks.
Cordite, Mark I Cordite, M.D. - Cordite, M.C. -	} Charges for guns - - -	Cordite, M.C., is a slight modification of M.D., see page 9.
Cordite, M.D.T. (tubular).		
Cordite, N.C.T.	Some S.A.A. charges - - -	Very little used in N.S., but may be found in some S.A. ammunition.
Gunpowder -	See Table A - - -	

TABLE 2.
B.L. Charges.

Nature of Gun and Mark, Service Charge unless otherwise stated.	stated in Col. 1). How Charge is made up.	or M.C. Cordite.	Weight of Powder in Igniter. (ozs.)	Diameter and Length of Charge.	Cases in which supplied.	Number of Charges supplied in one case.
15-inch I - -	428 lbs., quarters.	45	16	11.7" × 26"	M cyl.	2 quarters.
13.5-inch V, heavy.	297 lbs., quarters.	45	16	10.5" × 22.5"	L. cyl.	2 quarters.
13.5-inch V, light	293 lbs., quarters.	45	16	10.25" × 22.5"	L. cyl.	2 quarters.
12-inch X - -	258 lbs., quarters.	45	16	10.5" × 19.0"	N. cyl.	2 quarters.
12-inch XI and XII.	307 lbs., quarters.	45	16	10.4" × 24"	L. cyl.	2 quarters.
12-inch IX for "M" submarines.	246 lbs., quarters.	45	16	10.4" × 18.4"	N. cyl.	2 quarters.
7.5-inch I-II** V and VI.	61 lbs., $\frac{1}{2}$ and $\frac{1}{4}$.	26	6	7" × 22.5" 7" × 11.35"	O. rect.	4 halves or 8 quarters.
6-inch VII, XVII and XVIII.	28 $\frac{1}{2}$ lbs., $\frac{1}{2}$ and $\frac{3}{4}$.	26	2	6.1" × 28.5" full.	T. rect.	4 full.
6-inch XIII, XVII, XVIII, star charge.	11 lbs.	11	2	5.25" × 30"	T. rect.	6 star.
6-inch XVI, "Erin."	33 lbs., $\frac{1}{2}$ and $\frac{3}{4}$.	26	2	6.2" × 31.2"	T. rect.	
6-inch XI and XI*.	32 lbs., $\frac{1}{2}$ ozs. $\frac{1}{2}$ and $\frac{3}{4}$.	26	2	6.2" × 31"	T. rect.	
6-inch XII - -	27 $\frac{1}{2}$ lbs., $\frac{1}{2}$ and $\frac{3}{4}$.	19	2	5.25" × 36.2"		
6-inch VII - -	23 lbs., halves.	16	2	6" × 25.5" 6" × 12.75"		
6-inch VII - -	20 lbs., halves.	20	2	5.7" × 23.6" 5.75" × 11.75"		
6-inch VII, XI, XII and XVI, star charge.	12 lbs.	11	2	5.25" × 30"		
5.5-inch I - -	22 $\frac{1}{2}$ lbs., $\frac{1}{2}$ and $\frac{3}{4}$.	19	2	5.25" × 29.1"	T. rect.	5 full.
5.5-inch I, star charge.	9 lbs., 13 ozs.	11	2	5.25" × 31"	T. rect.	6 star.
4.7-inch I - -	11 $\frac{1}{2}$ lbs.	16	1	4.25" × 25.2"	O. rect., W. rect.	12 full.
4.7-inch I, star charge.	5 lbs., 3 $\frac{1}{2}$ ozs.	11	1	4.25" × 25.2"	O. rect.	12 star.
4-inch VIII - -	5 $\frac{1}{2}$ lbs.	16	1	3.84" × 13.2"	R. rect. or O.	7 full.
4-inch VIII, star and practice charge.	2 lbs., 2 $\frac{1}{2}$ ozs.	8	1	3.5" × 15"	R. rect.	15 star.
4-inch VII - -	9 lbs., 5 $\frac{1}{2}$ ozs.	16	1	4.3" × 17.2"	R. rect.	6 full.
4-inch VII, star charge.	3 $\frac{1}{2}$ lbs.	8	1	3.5" × 26"	O. rect.	16 star.
4-inch VII, practice charge	6 lbs., 9 ozs.	16	1	4" × 17.5"	R. rect.	8 practice.
4-inch IX - -	7 lbs., 11 ozs.	16	1	3.6" × 22.7"	O. rect.	18 full.
4-inch IX, star charge.	3 $\frac{1}{2}$ lbs.	8	1	3.5" × 25.25"	O. rect.	16 star.
4-inch IX, practice charge.	4 $\frac{1}{2}$ lbs.	11	1	4" × 12"	O. rect.	32 practice.

TABLE 3.
Q.F. Charges.

Nature of Q.F. Gun.	Weight of Charge.	Size of M.D. or M.C. Cordite (or Mark I as shown).	Means of ignition.	Maximum Dimension of Cartridge. Diam. Length.	Q.F. Boxes in which supplied.		No. of Charges in Box.
4.7" V and V*	8 lbs., 10½ ozs.	16	Adapter VI, Met. ig.	6.1" × 26.1"	C.17	-	4
4-inch VII, fixed	5 lbs., 7 ozs.	16	No. 1 PP, 1½ oz. ig.	5.6" × 35.1"	C.48 or C.154.		4
4-inch V and V*, fixed.	5 lbs., 14 ozs.	11	No. 1 PP.	5.7" × 43.2" (H.E. fuzed).	C.155	-	4
4-inch V and V*, sep.	7 lbs., 11 ozs.	16	No. 1 PP. 4 drm. ig.	5.7" × 27.6"	C.23	-	6
4-inch V and V, fixed and separate star and practice.	3 lbs., 2 ozs.	8	No. 1 PP. 3 drm. ig.	5.7" × 42.4" 5.7" × 27.6"	C.155 - C.23 -		4 6
4-inch IV, separate rate.	5 lbs., 1½ ozs.	16	No. 1 PP -	5.4" × 19.5"	C.22		6
4-inch IV, separate star and practice.	2 lbs., 5½ ozs.	8	No. 1 PP -	5.4" × 19.5"	C.22		6
4-inch IV and XII, fixed.	5 lbs., 2½ ozs.	16	No. 1 PP	5.4" × 34.8" (C.P.).	C.154 -		4
4-inch III -	3 lbs., 9 ozs.	15 Mark I	Adapter, 1½ oz. ig.	5.5" × 14.6"	C.21	-	8
3-inch, 20-cwt. 16-lbs. proj.	2 lbs., 2½ ozs.	11	No. 1 PP	4.6" × 27.8" (H.E. fuzed).	C.62	-	4
3-inch, 20-cwt. 12½-lbs. proj.	2 lbs., 8½ ozs.	11	No. 1 PP	4.6" × 27.4"	C.61 or C.62.		4
3-inch, 20-cwt. star.	1 lb., ¼ oz.	4½	No. 1 PP	4.6" × 26.3"	C.62	-	4
3-pdr. -	1 lb., 4½ ozs.	8	No. 1 PP	3.6" × 21.5" (C.P.).	C.54	-	4
12-pdr., 12-cwt. -	2 lbs.	11	Adapter, met. ig.	4.1" × 15.5"	C.33	-	10
Do. do. -	13½ ozs. -	4½	Adapter, met. ig. do.	4.1" × 15.5"	C.33	-	10
Reduced star shell charge.	13 ozs. 6 drs.	4½	do.	4.1" × 15.5"	C.33	-	10
12-pdr., 8-cwt. -	13½ ozs. -	10 Mark I	Adapter, met. ig.	4.1" × 7.9"	C.35	-	10
12-pdr., 4-cwt. -	1 lb., ½ oz.	8	No. 1 PP	3.5" × 8.6"	C.37	-	8
6-pdr. -	8 ozs., 11½ drms.	4½	No. 2 PP	3" × 20.5"	C.85, 86 or C.126.		11 12
3-pdr. -	7½ ozs. -	4½	No. 2 PP	2.6" × 21.0" (H.E. fuzed).	C.94	-	16
3-pdr. Vickers -	13½ ozs. -	8	No. 2 PP	2.7" × 23.4" (C.N.F. fuzed).	C.97, 98 or C.101.		16 12
3-pdr. Vickers, reduced.	76½ ozs. -	4½	No. 2 PP	2.7" × 22"	C.98	-	16
2-pdr., Marks I and II.	3 ozs., 124 grs.	7½ Mark I	No. 5 PP	1.9" × 11.8"	C.102	-	50

TABLE 4.

Rectangular Cases.

Case.	Guns used for	No Charges in Case.	Weight empty. Lbs.	Weight full. Lbs.	Stowage Dimensions.	
					Inches. Section.	Inches. Length.
O. VI -	7.5-inch B.L. I-II**, V and VI.	4½ or 8½	62	190	15.1 × 15.1 × 29.2	
	4.7-inch B.L. I -	12 full	—	200	—	—
	4-inch B.L. IX -	18 full	—	213	—	—
R. II or III -	4-inch B.L. VII -	6 full	36	93	9.3 × 13.6 × 21.0	
	4-inch B.L. VIII -	7 full	—	75	—	—
T. II -	6-inch B.L. VII, IX, XVII and XVIII.	4 full	56½	190	13.7 × 13.7 × 33.5	
T.V. -	6-inch B.L. VII, VIII, IX, XI, XI*, XVII and XVIII.	4 full	56	178	13.7 × 13.7 × 33.5	
	5.5-inch B.L. I -	5 full	—	168	—	—
W. -	6-inch B.L. XII -	4 full	51	162	11.9 × 11.9 × 38.9	

TABLE 5.

Cylindrical Cases.

Case.	Guns used for	No Charges in Case.			Inches. Length.
M.I. and I.C. -	15-inch B.L. I - -	2 quarters	156	375	13.8 × 54.7
M. II, II* -	Do. - -	Do.	—	—	14.2 × 54.7
L. I, L.I.C. -	13.5-inch B.L. V., light	Do.	120	270	12.8 × 50.4
					12.8 × 50.4
L. III, L. III* and L. IV.	13.5-inch B.L. V., heavy	Do.	120	272	12.8 × 50.7
					12.8 × 50.7
N. - -	12-inch B.L. IX, X and XI.	Do.	98	229	12.3 × 40.1

TABLE 6.

Q.F. Cartridge Boxes.

No. of Box.	Nature of Guns used with	No. of Charges in Box.	Weight empty. Lbs.	Weight full. Lbs.	Stowage Dimensions. Inches.
C.17 -	4.7-inch Q.F. V. and V*	4	74	174	29.2 × 14.4 × 13.7
C.21 -	4-inch Q.F. III, separate	8	51	161	17.5 × 12.5 × 21.7
C.22 -	4-inch Q.F. IV, separate	6	58	140	17.1 × 13.3 × 23
C.23 -	4-inch Q.F. V and V* separate.	6	71	200	20.2 × 14.7 × 31.1
C.33 -	12-pdr., 12-cwt.	10	48	131	18.3 × 10.5 × 20
C.35 -	12-pdr., 8-cwt.	10	33	77	10.6 × 10 × 20.5
C.36 -	12-pdr., 8-cwt.	10	33	77	11.0 × 11.2 × 21.1
C.37 -	12-pdr., 4-cwt.	8	28	56	15.7 × 10 × 12.1
C.48 -	4-inch Q.F. VII, fixed	4	84	280	36.9 × 13.5 × 14.4
C.54 -	13-pdr.	4	54	126	10.3 × 12.2 × 24.8
C.61 -	3-inch, 20-cwt. H.A. 12½-lb. proj.	4	85½	188	12.1 × 13.4 × 29.8
C.62 -	3-inch, 20-cwt. H.A., 16-lb. proj.	4	86	178	12.1 × 13.4 × 32.6
C.85 and 86	6-pdr.	11	32½	147½	10.2 × 16.4 × 21.3
C.94 -	3-pdr.	16	37	139½	12.7 × 14.4 × 25.8
C.97 and 98	3-pdr. Vickers	16	53	169	13.7 × 15.7 × 24.6
C.100 and 101.	3-pdr. Vickers	16	53	169	13.1 × 14.8 × 27.3
C.102 -	2-pdr., Marks I and II	50	37	168	13.5 × 15.6 × 22.3
C.126 -	6-pdr.	12	34	159½	12.2 × 16.2 × 25.7
C.154 -	4-inch Q.F. IV, VII and XII, fixed.	4	96	308	13.6 × 15.1 × 39.8
C.155 -	4-inch Q.F. V and V*, fixed.	4	87	323	13.9 × 15.4 × 48.9
C.39 -	6-pdr. saluting	20	25½	67½	11.8 × 12 × 25.8
C.40 -	3-pdr. saluting	20	21½	53½	11.8 × 11.5 × 22.3

TABLE 7.

Metal-Lined Cases.

QUARTER METAL-LINED CASE - Weight, empty, 19 lbs.
Dimensions, 10·4" × 11·2" × 14·7".

To hold	No. of	Weight, full.
·303-inch ball - - -	1,200	88 lbs.
·303-inch ball in chargers - -	840	76½ lbs.
·303-inch blank - - -	1,450	72 lbs.
Morris tube ammunition - - -	9,100	108 lbs.
R.F. cartridges - - -	10,000	104 lbs.
Very's lights - - -	120	36 lbs.
Torpedo impulse charges - - -	60	56 lbs.
Tonite charges - - -	50	33½ lbs.
1½-inch V.B.S. lights - - -	48	32 lbs.
Safety fuze cartridges - - -	100	24 lbs.

HALF METAL-LINED CASE - - Weight, empty, 30 lbs.
Dimensions, 13·6" × 14·3" × 17·7".

To hold	No. of	Weight, full.
·303-inch blank - - -	3,400	124½ lbs.
3-pdr. saluting (11 oz.) - - -	50	75 lbs.
3 pdr. Vickers saluting - - -	43	67 lbs.
6-pdr. saluting - - -	37	72 lbs.
12-pdr., 8-cwt. saluting - - -	20	74 lbs.
12-pdr., 12- and 18-cwt. saluting	30	81 lbs.
6-pdr. blank - - -	20	72 lbs.
3-pdr. blank - - -	25	76 lbs.
3-inch H.A. blank - - -	30	80 lbs.
3·5-inch B.T. charges - - -	18	200 lbs.
Sound signal rockets - - -	35	58 lbs.
Very's lights - - -	300	62 lbs.
1½-inch V.B.S. lights - - -	144	69 lbs.
Filled maxim belts - - -	5	107½ lbs.

WHOLE METAL-LINED CASE - Weight, empty, 50 lbs.
Dimensions, 17·6" × 17·0" × 21·625"

To hold	No. of	Weight, full.
·303-inch blank	7,680	264 lbs.
Sound signal rockets	70	102 lbs.
4·7 inch blank -	10	140 lbs.

TABLE 8.

Small Arm Ammunition Boxes.

WHOLE S.A.A. Box - Weight, empty, $12\frac{1}{2}$ lbs.
Dimensions, $21\cdot82'' \times 8\cdot4'' \times 7''$.

To hold	No. of	Weight, full.
·303-inch ball - - - -	1,000	88 $\frac{1}{2}$ lbs.
·303-inch ball in bandoliers - -	840	80 $\frac{1}{2}$ lbs.
·303-inch ball, Mark VII, in chargers	840	78 $\frac{1}{2}$ lbs.
·303-inch blank - - - -	1,100	—
·45-inch aiming ball - - - -	680	101 $\frac{1}{2}$ lbs.
1-inch aiming electric and percussion -	96	109 $\frac{7}{8}$ lbs.

HALF S.A.A. Box Weight, empty, 6 lbs. $13\frac{3}{4}$ ozs.
Dimensions, $10\cdot88'' \times 8\cdot4'' \times 7''$.

To hold	No. of	Weight, full.
·303-inch ball - - - -	500	44 lbs. $5\frac{1}{4}$ ozs.
·303-inch ball, Mark VII, in chargers	360	36 lbs. $1\frac{3}{4}$ ozs.
·303-inch blank - - - -	600	30 lbs. $13\frac{3}{4}$ ozs.
Webley pistol ball - - - -	828	50 lbs. $13\frac{3}{4}$ ozs.
Lewis gun, ·303-inch ball, Mark VII, packed in bundles.	480	—
Lewis gun, ·303-inch ball, Mark VII, tracer, packed in bundles.	480	—

Note.—·303-inch tracer ammunition may also be supplied packed in a Land Service S.A.A. box containing 1,280 rounds.

TABLE 9.

Shell manufactured for B.L. Guns, 12-inch and above, and
Fuzes supplied for use in them.

Gun.	A.P.C.	C.P.C.	C.P.	H.E.	Shrapnel.
	Shellite.	Powder.	Powder.	T.N.T.	Powder.
15-inch	} 16 D. Mark IV.	15	No C.P. shells above 12-inch.	45 or 44	93
13·5-inch, heavy					
13·5-inch, light					
12-inch, Marks X, XII and XIII.	—	15	15	44 or 45	93
12-inch, Marks VIII and IX.					

Notes.—H.E. have T.N.T. exploders. Shellite filled shell have picric powder exploders.

H.E. shell are kept in reserve and only supplied to ships when required for bombarding purposes.

TABLE 10.

Shell manufactured for B.L. Guns, 7·5-inch to 5·5-inch, and
Fuzes supplied for use in them.

Gun.	C.P.C.		C.P.	H.E.	Shrapnel.	Star.
	Shellite.	Powder.	Powder.	Lyddite or T.N.T.		
7·5"	16 D.	15	15	18 P, 45 P or 44.	93	—
6"	16 D.	15	15	18 P, 45 P or 44.	93	81 or 181.
5·5"	16 D.	15	None	18 P, 45 P or 44.	92 or 192	81 or 181.

TABLE 11.

Shell manufactured for B.L. and Q.F. Guns, 4·7-inch to 12-pdr., and Fuzes supplied for use in them.

Gun	Semi A.P.	C.P.	H.E.	Shrapnel	Target Smoke.	Star.
	Lyddite	Powder	Lyddite or T.N.T.	Powder.		
4·7" B.L., Mk. I	12 N. Special.	12, 12 F.	18 P or 45 P or 44.	92 or 192.		181 or 81.
4·7" Q.F., V	12 N Special.	12, 12 F.	18 P or 45 P or 44.			
4" B.L. or Q.F. except Q.F. I —III and V, fixed.	12 F Special.	12, 12 F	18 P or 45 P or 44.	92 or 192.		181 or 81.
4" Q.F., V, fixed			202 or 192 and 8 gaine.		192 and No. 8 gaine.	181 or 81.
4" Q.F., I—III		12, 12 F.	18 P or 45 P or 44.	92 or 192.		181 or 81.
3", 20-cwt. 12½- lb. shell.	12 F Special.	12, 12 F.	18 P or 45 P or 44 or 185, and 7 gaine.	185	185 and No. 2 gaine.	181 or 81.
3", 20-cwt. 16- lb. shell.			18 P or 45 P or 44, or 80/44 or 202 (with No. 7 or 8 gaine).			181 or 81.
13-pdr. - -		12, 12 F.	18 P or 45 P or 44.	92 or 192.		181 or 81.
12-pdr. and 12- cwt.	12 F Special.	12, 12 F.	18 P or 45 P or 44.	65 A or 92 or 192.		181 or 81.
12-pdr., 8-cwt.		12, 12 F.	18 P or 45 P or 44.	65 A or 92 or 192.		

TABLE 12.

Shell manufactured for 6-pdr. and below and Fuzes supplied for use in them.

Gun.	C.P.	Nose-fuzed Common.	H.E.
	Powder.	Powder.	Lyddite.
6-pdr. and 3-pdr. Hotchkiss	Hotchkiss III* or IV.	—	19 A or 44.
6-pdr. Vickers	Hotchkiss III* or IV.	—	—
3-pdr. Vickers	Hotchkiss III* or IV.	—	19 A or 44.
2-pdr. Pom-pom	Hotchkiss IV**** or VIII only.	121 or 124	

Note 1 :—6-pdr. and below H.E. lyddite filled have T.N.T. exploders only.

Note 2 :—Until Hotchkiss IV**** or VIII are available, III* or IV may be used in 2-pdr.

TABLE 13.

Fuzes used in Naval Service.

No. of Fuze.	Nature of Fuze.	Marks in use.	Projectile in which used.	Nature of Gun.	Remarks.
No. 8 (40'). No. 8A (90'). No. 8B (140'). No. 8E (190'). No. 12 No. 12F No. 12F special. No. 12N special.	Percussion base Hotchkiss.	III*, IV	Steel common shell.	6-pdr. and 3-pdr.	
	Percussion base Hotchkiss.	IV****, VIII	Steel common shell.	2-pdr.	
No. 15	Hydrostatic valve.		Spherical anti-submarine bomb.	All weapons from which bombs are fired.	
No. 12F special.	Percussion base medium.	VIII, VIIIA. IX, X and XI	C.P. shell	4.7-inch to 12-pdr.	
No. 12N special.	Percussion base medium.	IX, X and XI	Semi A.P. shell	4-inch and below	Weak creep spring. No creep spring.
No. 15	Percussion base large.	IV, IV* and IV* R.	C.P.C. shell, filled powder.	5.5-inch and above 6-inch to 12-inch.	
No. 15	Percussion base large.	V R	C.P.C. shell, filled powder.	5.5-inch and 6-inch only.	
No. 16D	Percussion base large.	IV	A.P.C. or C.P.C., filled shellite.	5.5-inch and above.	Delay fuze.
No. 18P No. 45P	Direct action impact.	I and II, II, II/VII and VIII.	H.E. shell	7.5-inch to 12-pdr.	Powder filled fuzes.
No. 19A	Direct action impact.	I	H.E. shell	6 and 3-pdr.	Detonating fuze.
No. 44	Direct action.	II**, III* and IV.	H.E. shell	15-inch to 12-pdr.	Detonating fuze for bombardment.
No. 45	Direct action impact.	I and II	H.E. shell	5.5-inch and above.	Detonating fuze.
No. 65A	Time and percussion.	I	Shrapnel shell	12-pdr. and 4-inch (light).	G.S. fuze hole.
No. 65A	Time and percussion.	I	C.N.F., filled powder.	6-pdr.	
No. 80/44	Time	X	H.E. 16-lb. shell	3-inch, 20-cwt.	With No. 7 or No. 8 gains.
No. 81	Time and percussion.	II	Star shell	6-inch to 12-pdr.	
No. 181	Time	I	Star shell	6-inch to 12-pdr.	
No. 92	Time and percussion.	I and II	Shrapnel shell	5.5-inch and below 4-inch Q.F. Mark V.	
No. 192	Time	I	Shrapnel shell	5.5-inch and below.	
No. 93		I	Target smoke shell.	4-inch Q.F. Mark V.	
No. 121 No. 124		II and III, I and II.	H.E. (high angle). Shrapnel shell	6-inch and above	
No. 121 No. 124		II and III, I and II.	Common nose-fuzed.	2-pdr.	Used with automatic fuze setter.
No. 185			H.E. shell (12½-lb.). Target smoke shell.	3-inch, 20-cwt.	American nose exhaust fuze.
No. 185			Shrapnel shell	3-inch, 20-cwt.	

TABLE 14.

Ammunition used by each nature of Gun.

15-inch B.L. Mark I.

Nominal weight of gun.—100 tons.

Length of bore.—52' 6" or 42 calibre.

Length of gun.—54' 2.4".

Full charge.—428 lbs. M.D. cordite, size 45, made up in $\frac{1}{4}$ charges and supplied two $\frac{1}{4}$ charges in "M" cylindrical case.

Projectile.—Approximate weight 1,920 lbs. (4 c.r.h.) Fuzes.

A.P.C. shellite - - - - - No. 16 D.

C.P.C. powder - - - - - No. 15.

Shrapnel (13,985 balls, 27 to 1 lb.) - - - No. 93.

Practice shot.

Tubes.—Large.

13.5-inch B.L. Mark V.

Nominal weight of gun.—76 tons.

Length of bore.—50' 7 $\frac{1}{2}$ " or 45 calibre.

Length of gun.—52'.

Full charge.—Heavy, 297 lbs.; light, 293 lbs.; M.D. cordite, size 45, made up in $\frac{1}{4}$ charges and supplied two $\frac{1}{4}$ charges in "L" cylindrical case.

Projectiles.—Approximate weight (4 c.r.h.), heavy 1,400 lbs., light 1,250 lbs.

	Fuzes.
A.P.C. shellite - - - - -	No. 16 D.
C.P.C. powder - - - - -	No. 15.
Shrapnel (11,907 balls, 27 to 1 lb. for heavy) (10,280 balls, 27 to 1 lb. for light.)	No. 93.

Tubes.—Large.

12-inch B.L. Marks XI and XII.

Nominal weight of gun.—67 tons.

Length of bore.—50' or 50 calibres.

Length of gun.—51' 6".

Full charge.—307 lbs. M.D. cordite, size 45, made up in $\frac{1}{4}$ charges and supplied two $\frac{1}{4}$ charges in "L" cylindrical case.

Projectile.—Approximate weight, 850 lbs. (4 c.r.h.) Fuzes.

A.P.C. shellite - - - - - No. 16 D.

C.P.C. powder - - - - - No. 15.

Shrapnel (348 steel 12 oz. balls, or 7,766 metal balls 27 to 1 lb.) - - - - - No. 93.

Tubes.—Large.

Table 14—contd.

12-inch B.L. Marks X and X*.

Nominal weight of gun.—58 tons.

Length of bore.—45' or 45 calibres.

Length of gun.—46' 4".

Full charge.—258 lbs. M.D. cordite, size 45, made up in $\frac{1}{4}$ charges and supplied two $\frac{1}{4}$ charges in "N" cylindrical case.

Projectile.—Approximate weight, 850 lbs. (4 c.r.h.) Fuzes.

A.P.C. shellite - - - - - No. 16 D.

C.P.C. powder - - - - - No. 15.

Shrapnel (348 steel 12-oz. balls, or 7,766 metal balls 27 to 1 lb.) - - - - - No. 93.

Practice shot.

Tubes.—Large.

12-inch B.L. Mark IX.

Nominal weight of gun.—50 tons.

Length of bore.—40' or 40 calibres.

Length of gun.—41' 3.6".

Full charge.—For Submarines, 246 lbs., M.D. cordite, size 45, made up in $\frac{1}{4}$ charges and supplied two $\frac{1}{4}$ charges in "N" cylindrical case.

Projectiles.—Approximate weight, 850 lbs. (4 c.r.h.) Fuzes.

C.P.C. - - - - - No. 15.

H.E. T.N.T. - - - - - No. 44 or 45.

Practice shot.

Tubes.—Small.

7.5-inch B.L. Marks, I, II*, V and VI.

Nominal weight of gun.—Marks I and VI, 14 tons.

Marks II* and V, 15 tons.

Length of bore.—Marks I and VI, 28' 1 $\frac{1}{2}$ " or 45 calibres.

Marks II* and V, 31' 3" or 50 calibres.

Length of gun.—Marks I and VI, 29' 1.2".

Marks II* and V, 32' 2.7".

Full charge.—61 lbs. M.D. cordite, size 26, made up in $\frac{1}{2}$ and $\frac{1}{4}$ charges and supplied four $\frac{1}{2}$ or eight $\frac{1}{4}$ charges in "O" rectangular cases.

Projectile.—Approximate weight, 200 lbs. (4 c.r.h.)

Fuzes.

C.P.C. shellite - - - - - No. 16 D.

C.P.C. powder - - - - - No. 15.

H.E. lyddite - - - - - No. 18 P or 45 P or 44.

Shrapnel (368 2-oz. balls) - - - - - No. 93.

Practice shot.

Tubes.—Small, except in Mark VI, large,

Table 14—contd.

6-inch B.L. Mark XII.

Nominal weight of gun.—7 tons.

Length of bore.—22' 6" or 45 calibres.

Length of gun.—23' 3½".

Full charge.—27½ lbs. M.D. cordite, size 19, made up in ⅔ and ⅓ charges and supplied 4 rounds in a "W" case.

Star charge.—12 lbs. M.D. cordite, size 11, supplied 6 rounds in "T" case.

Reduce practice charge.—The ⅔ charge.

Blank charge.—7 lbs. L.G.

Projectiles (A.Q.).—Approximate weight, 100 lbs. (4 c.r.h.)

Fuzes.

C.P.C. shellite - - - -	No. 16 D.
C.P.C. powder - - - -	No. 15.
H.E., T.N.T. or lyddite - - -	No. 18 P or 44 or 45 P.
Shrapnel (854 balls 27 to 1 lb., or 450 bullets) - - - -	No. 93.
Star shell - - - -	No. 81 or 181.

Tubes.—Large.

6-inch B.L. Marks XI and XI*.

Nominal weight of gun.—8 tons 12 cwt.

Length of bore.—25' or 50 calibres.

Length of gun.—25' 9½".

Full charge.—32 lbs. 1½ ozs. M.D. cordite, size 26, made up in ⅓ and ⅔ charges and supplied 4 rounds in a "T" case.

Star charge.—12 lbs. M.D. cordite, size 11, supplied 6 rounds in a "T" case.

Reduced practice charge.—The ⅔ charge.

Blank charge.—7 lbs. L.G.

Projectiles.—Same as for the Mark XII gun.

Tubes.—Small.

6-inch B.L. Mark VII.

Nominal weight of gun.—7½ tons.

Length of bore.—22' 5½" or 44.9 calibres.

Length of gun.—23' 3".

Full charge.—28½ lbs. M.D. cordite, size 26, made up in ⅔ and ⅓ charges and supplied 4 rounds in a "T" case.

Star charge.—12 lbs. M.D. cordite, size 11, supplied 6 rounds in a "T" case.

Reduced practice charge.—The ⅔ charge.

Table 14—contd.

Blank charge.—7 lbs. L.G.

Projectiles.—Same as for Mark XII gun.

Tubes.—Small.

Full charge.—23 lbs. M.D. cordite, size 16, or 20 lbs. Mark I cordite, size 20, made up in halves and supplied 7 rounds in a "B" case.

Reduced practice charge.—The half charge.

Blank charge.—7 lbs. L.G.

Projectiles.—Approximate weight, 100 lbs. (2 c.r.h.) with copper gas-check driving band.

Fuzes.

C.P. (powder) - - -	-	No. 15.
H.E. (lyddite or T.N.T.) -	-	No. 18 P or 44 or 45 P.
Shrapnel - - -	-	No. 93.
Practice shot.		

Tubes.—Small.

5·5-inch B.L. Mark I.

Nominal weight of gun.—6 tons $4\frac{1}{2}$ cwt.

Length of bore.—22' 11" or 50 calibres.

Length of gun.—23' 9·1".

Full charge.—22 $\frac{1}{4}$ lbs. M.D. cordite, size 19, made up in $\frac{2}{3}$ and $\frac{1}{3}$ charges and supplied 5 rounds in a "T" case.

Star charge.—9 lbs. 13 ozs. M.D. cordite, size 11, supplied 6 in a "T" case.

Reduced practice charge.—The $\frac{2}{3}$ charge.

Projectiles.—Approximate weight, 82 lbs. (4 c.r.h.)

Fuzes.

C.P.C. shellite - - -	-	No. 16 D.
C.P.C. powder - - -	-	No. 15.
H.E. lyddite - - -	-	No. 18 P or 44 or 45 P.
Shrapnel (751 balls, 27 to 1 lb.	-	No. 92 or 192.
Star shell - - -	-	No. 81 or 181.
Practice shot.		

Tubes.—Large.

4·7-inch B.L. Mark I.

Nominal weight of gun.—3 $\frac{1}{2}$ tons.

Length of bore.—17' 8·58" or 45 calibres.

Length of gun.—18' 3·7".

Full charge.—11 lbs. 6 ozs. M.D. cordite, size 16, made up in one charge and supplied 12 rounds in an "O" case.

Table 14—contd.

Star or practice charge.—5 lbs. $3\frac{1}{2}$ ozs. M.D. cordite, size 11, supplied 12 in an "O" case.

Blank charge.—6 lbs. L.G.

Projectiles.—Approximate weight, 50 lbs. (4 c.r.h.)

	Fuzes.
Semi A.P. lyddite - - - -	No. 12 N, special.
C.P. - - - -	No. 12 or 12 F.
H.E., lyddite - - - -	No. 18 P or 44 or 45 P.
Shrapnel - - - -	No. 92 or 192.
Star shell - - - -	No. 81 or 181.
Practice shot.	

Tubes.—Large.

4-inch B.L. Mark VII.

Nominal weight of gun.—42 cwt.

Length of bore.—16' $9\frac{1}{4}$ " or 50.3 calibres.

Length of gun.—17' 4.5".

Full charge.—9 lbs. 5 ozs. 15 drms. M.D. cordite, size 16, made up in one charge and supplied 6 rounds in "R" case.

Star charge.—3 lbs. 12 ozs. M.D. cordite, size 8, supplied 16 in "O" case.

Reduced practice charge.—6 lbs. 9 ozs. M.D. cordite, size 16, supplied 8 rounds in "R" case.

Blank charge.—3 lbs. L.G.

Projectiles.—Approximate weight, 31 lbs. (3 c.r.h.)

	Fuzes.
Semi A.P. lyddite - - - -	No. 12 F, special.
C.P. - - - -	No. 12 or 12 F.
H.E., T.N.T. or lyddite - - - -	No. 18 P or 44 or 45 P.
Shrapnel - - - -	No. 92 or 192.
Star shell - - - -	No. 81 or 181.
Practice shot.	

Tubes.—Large.

4-inch B.L. Mark VIII.

Nominal weight of gun.—26 cwt.

Length of bore.—13' 3.2" or 39.8 calibres.

Length of gun.—13' 10.4".

Full charge.—5 lbs. 6 ozs. M.D. cordite, size 16, made up as one charge, and supplied 9 rounds in "R" case or 32 rounds in "O" case.

Star charge.—2 lbs. $2\frac{3}{4}$ ozs. M.D. cordite, size 8, supplied 15 rounds in "R" case.

Blank charge.—3 lbs. L.G.

Projectiles.—As for Mark VII.

Tubes.—Large.

Table 14—contd.

4-inch B.L. Marks IX and IX*.

Nominal weight of gun.—42½ cwt.

Length of bore.—14' 9·4" or 44·35 calibres.

Length of gun.—15' 4·6".

Full Charge.—7 lbs. 11 ozs. M.D. cordite, size 16, made up in one charge, and supplied 18 rounds in "O" case.

Star charge.—3½ lbs. M.E. cordite, size 8, supplied 16 in "O" case.

Reduced practice charge.—4½ lbs. M.D. cordite, size 11, supplied 32 in "O" case.

Blank charge.—3 lbs. L.G.

Projectile.—Same as for Mark VII.

Tubes.—Large.

4·7-inch Q.F. Marks V and V*.

Nominal weight of gun.—2 tons 13 cwt.

Length of bore.—17' 3·5" or 43·9 calibres.

Length of gun.—17' 8·6".

Full charge.—8 lbs. 10½ ozs. M.D. cordite, size 16, made up as separate ammunition with metal igniter and adapter. Supplied 4 rounds in Q.F. box.

Projectiles.—Approximate weight, 45 lbs. (2 c.r.h.)

Fuzes.

Semi A.P., lyddite	-	-	-	No. 12 N, special.
C.P.	-	-	-	No. 12 or 12 F.
H.E., T.N.T. or lyddite	-	-	-	No. 18 P or 44 or 45 P.
Shrapnel	-	-	-	No. 92 or 192.
Practice shot.				

Tubes.—Small.

4-inch Q.F. Mark VII Fixed.

Nominal weight of gun.—26 cwt.

Length of bore.—40·5 calibres.

Length of gun, 14' 4·1".

Full charge.—5 lbs. 7 ozs. M.D. cordite, size 16, made up as fixed ammunition with igniter and No. 1 percussion primer, and supplied 4 in a Q.F. box.

Projectiles.—Approximate weight, 31 lbs. (3 c.r.h.)

Fuzes.

S.A.P., lyddite	-	-	-	No. 12 F, special.
C.P.	-	-	-	No. 12 or 12 F.
H.E., T.N.T. or lyddite	-	-	-	No. 18 P or 45 P or 44.
Practice shot.				

Table 14—contd.

4-inch Q.F. Marks V and V* Fixed.

Nominal weight of gun.—43 cwt.

Length of bore.—45 calibres.

Length of gun.—15' 7.8".

Full charge.—5 lbs. 14 ozs. M.D. cordite, size 11. Made up as fixed ammunition with No. 1 percussion primer, and supplied 4 in a Q.F. box.

Star charge.—3½ lbs. M.D. cordite, size 8, supplied 4 in a Q.F. box.

Target smoke charge.—Full charge.

Projectiles.—Approximate weight, 31 lbs. (6 c.r.h.)

	Fuzes.		
H.E., T.N.T. or lyddite	-	-	No. 192.
Target smoke shell	-	-	No. 92 or 192.
Star shell	-	-	No. 81 or 181.
Practice shot.			

4-inch Q.F. Marks V and V* Separate.

Nominal weight of gun.—43 cwt.

Length of bore.—45 calibres.

Length of gun.—15' 7.8".

Full charge.—7 lbs. 11 ozs. M.D. cordite, size 16. Made up as separate ammunition with igniter and No. 1 percussion primer, and supplied 6 rounds in a Q.F. box.

Star charge.—3½ lbs. M.D. cordite, size 8, supplied 6 rounds in a Q.F. box.

Blank charge.—3 lbs. L.G.

Projectiles.—Approximate weight, 31 lbs. (3 c.r.h.)

	Fuzes.		
Semi A.P., lyddite	-	-	No. 12 F. special.
H.E., T.N.T. or lyddite	-	-	No. 18 P or 44 or 45 P.
Shrapnel	-	-	No. 92.
Star shell	-	-	No. 81 or 181.
Practice shot.			

4-inch Q.F. Mark IV Separate.

Nominal weight of gun.—25 cwt.

Length of bore.—40 calibres.

Length of gun.—13' 10.6".

Full charge.—5 lbs. 1½ ozs. M.D. cordite, size 16. Made up as separate ammunition with igniter and No. 1 percussion primer, and supplied 6 in a Q.F. box.

Star and reduced practice charge.—2 lbs. 5½ ozs. M.D. cordite size 8, supplied 6 in a Q.F. box.

Blank charge.—3 lbs. L.G.

Projectiles.—Same as for Mark V above.

Table 14—contd.

4-inch Q.F. Marks IV and XII Fixed.**Nominal weight of gun.**—26 cwt.

Length of bore.—40 calibres.

Length of gun.—13' 10".

Full charge.—5 lbs. 2½ ozs. M.D. cordite, size 16. Made up as fixed ammunition with No. 1 percussion primer, and supplied 4 rounds in a Q.F. box.**Projectiles.**—Approximate weight, 31 lbs. (3 c.r.h.)

	Fuzes.
S.A.P., lyddite - - -	- No. 12 F, special.
C.P. - - - - -	- No. 12 or 12 F.
H.E., T.N.T. or lyddite	- No. 18 P or 45 P or 44.
Practice shot.	

4-inch Q.F. Mark III Separate.**Nominal weight of gun.**—26 cwt.

Length of bore.—40 calibres.

Length of gun.—13' 9¼".

Full charge.—3 lbs. 9 ozs. Mark I cordite, size 15, made up as separate ammunition with igniter and adapter, and supplied 8 in a Q.F. box.**Blank charge.**—3 lbs. L.G.**Projectiles.**—Approximate weight, 25 lbs. (2 c.r.h.)

	Fuzes.
C.P. - - - - -	- No. 12 or 12 F.
H.E., T.N.T. or lyddite	- No. 18 P or 45 P or 44.
Shrapnel - - - -	- No. 92.
Practice shot.	

3-inch Q.F. 20 cwt., Fixed H.A.**Nominal weight of gun.**—20 cwt.

Length of bore.—45 calibres.

Length of gun.—11' 8".

(a) **With 16-lb. shell.****Full charge.**—2 lbs. 2½ ozs. M.D. cordite, size 11, made up as fixed ammunition with No. 1 percussion primer Mark II, and supplied 4 rounds in a Q.F. box.**Projectiles.**—Approximate weight, 16 lbs. (6 c.r.h.)

	Fuzes.
H.E., T.N.T. or lyddite	- No. 18 P, 44 or 45 P or 80/44 or 180.

(b) **With 12½-lb. shell.****Full charge.**—2 lbs. 8 ozs. 1 dr. M.D. cordite, size 11, made up as fixed ammunition with No. 1 percussion primer, and supplied 4 rounds in a Q.F. box.

Table 14—contd.

Star charge.—1 lb. 4 drms. M.D. cordite, size 4½, supplied 4 in a Q.F. box.

Target smoke charge.—Full charge.

Projectiles.—Approximate weight, 12½ lbs. (2 c.r.h.)

		Fuzes.	
Semi A.P., lyddite	- -	No. 12 F,	special.
C.P.	- - - -	No. 12 or 12 F.	
H.E., T.N.T. or lyddite	- -	No. 18 P, 44 or 45 P or	185.
Shrapnel	- - - -	No. 185, 92 or 192.	
Target smoke shell	- -	No. 185 with No. 2 gaine.	
Star shell	- - - -	No. 81 or 181.	

13-pdr. Q.F. Fixed.

Nominal weight of gun.—6 cwt.

Length of bore.—23 calibres.

Length of gun.—6' 1.3".

Full charge.—1 lb. 4-ozs. 11 drms. M.D. cordite, size 8, made up as fixed ammunition with No. 1 percussion primer, supplied 4 rounds in Q.F. box.

Projectiles.—Approximate weight, 12½ lbs.

		Fuzes.	
C.P.	- - - -	No. 12 or 12 F.	
H.E., T.N.T. or lyddite	- -	No. 18 P or 44, or 45 P.	
Shrapnel	- - - -	No. 92 or 192.	

12-pdr. 12 cwt. Q.F.

Nominal weight of gun.—12 cwt.

Length of bore.—40 calibres.

Length of gun.—10' 3.6".

Full charge.—2 lbs. M.D. cordite, size 11, made up as separate ammunition with metal igniter and adapter. Supplied 10 rounds in Q.F. box.

Star shell charge.—13 ozs. 6 drms. M.D. cordite, size 4½, supplied 10 in box.

Blank charge.—1½ lbs.

Projectiles.—Approximate weight, 12½ lbs. (2 c.r.h.)

		Fuzes.	
Semi A.P., lyddite	- - - -	No. 12 F,	special.
C.P.	- - - -	No. 12 or 12 F.	
H.E., T.N.T. or lyddite	- -	No. 18 P or 44 or 45 P.	
Shrapnel	- - - -	No. 65 A or 92 or 192.	
Star shell	- - - -	No. 81 or 181.	
Practice shot.			

Tubes.—Small.

Table 14—contd.

12-pdr. 8 cwt. Q.F.

Nominal weight of gun.—8 cwt.

Length of bore.—28 calibres.

Length of gun.—7' 3·6".

Full charge.—13½ ozs. Mark I cordite, size 10, made up as separate ammunition with igniter and adapter, and supplied 10 rounds in a Q.F. box.

Blank charge.—1½ lbs. L.G.

Projectiles.—Approximate weight, 12½ lbs. (2 c.r.h.)

Fuzes.

C.P. - - - - - No. 12 or 12 F.

H.E., T.N.T. or lyddite - - No. 18 P or 44, or 45 P.

Shrapnel - - - - - No. 65 A or 92 or 192.

Practice shot.

Timber.—Small.

12-pdr. 4 cwt. Q.F.

Nominal weight of gun.—4 cwt.

Length of bore.—19·2 calibres.

Length of gun.—5' 1·8".

Full charge.—1 lb. ¾ oz. M.D. cordite, size 8, made up as separate ammunition with No. 1 percussion primers. Supplied 8 rounds in a Q.F. box.

Projectiles.—Approximate weight, 12½ lbs. (2 c.r.h.)

Fuzes.

C.P. - - - - - No. 12 or 12 F.

H.E., T.N.T. or lyddite - - No. 18 P or 44 or 45 P.

Shrapnel - - - - - No. 65 A or 92 or 192.

Practice shot.

3 and 6-pdr. Q.F.

	Hotchkiss.		Vickers.
	6-pdr.	3-pdr.	3-pdr.
Nominal weight of gun ...	7·18 cwt.	5 cwt.	6 cwt.
Length of bore, calibres...	40	40	50
Length of gun	8' 1½"	7' 6½"	8' 3".
Full charge, M.D., size 4¼ 8 ozs.	11½ drms.	7¼ ozs.	
„ „ M.D., size 8	—	—	13½ ozs.
No. of rounds in box ...	11	16	16.
Reduced charge, M.D., size 4¼	—	—	6⅞ ozs.
Blank charge, L.G. Powder	15 ozs.	11 ozs.	11 ozs.
Weight of Projectiles ...	6 lbs.	3 lbs. 5 ozs.	3 lbs. 5 ozs.
Projectiles.—C.P. steel with Hotchkiss base percussion fuze			
Mark III* or IV.			
H.E. with No. 19 A or 44 fuze.			
Practice shot.			

Table 14—contd.

Pom-pom 2-pdr. Marks I and II.

Full charge.—3 ozs. 124 grains Mark I cordite, size $7\frac{1}{2}$, supplied as fixed ammunition, 25 rounds in a belt and two belts in a Q.F. box.

Projectiles.—Common pointed with Hotchkiss fuze Mark IV**** or VIII.

Nose-fuzed common with No. 124 fuze.

Practice shot.

TABLE 15.

Stick Bombs, and Charges used with them.

Gun.	Projectile.	Weight (including Stick or Stick Bomb).	Weight of Burster T.N.T. or Amatol.	Charge.	Remarks.
4.7 - inch Q.F.	Stick bomb	Nominal 600 lbs., actual 563.	297 lbs.	3 lbs. 14 ozs. M.D.T. 15/13.	
		Nominal 500 lbs. actual 508.	257 lbs.		
		Nominal 250 lbs., actual 420.	200 lbs.		
		Nominal 200 lbs.	97 lbs.		
4-inch B.L. or Q.F.	Stick bomb	Nominal 350 lbs., actual 381.	200 lbs.	Mark IV and VIII, 2 lbs. 2 ozs. M.D.T. 15/13.	Supplied for B.L. R. case.
		Nominal 200 lbs., actual 231.	97 lbs.	Mark V and IX, 3 lbs. 4 ozs. M.D.T. 15/13.	Supplied for B.L. C.4 cartridge box. Not yet approved.
12-pdr. Q.F., 12-cwt.	Stick bomb	Nominal 200 lbs., actual 204	97 lbs.	1 lb. 15/13 M.D.T.	

APPENDIX I.

Coppering of Bores of Guns—Use of Tinfoil for Prevention and Removal.

The results of the trials carried out in the Fleet in accordance with A.F.O. 1107/21 show that the use of tinfoil has had a very beneficial effect as regards decoppering, but that, on the other hand, unless care is used, the introduction of the tinfoil by throwing in is liable to cause delays and jams, and entails a certain risk of damage to breech threads.

Heavy coppering of bores is a well-known cause of inaccurate shooting, and as the use of tinfoil is at present the best available method of preventing coppering continuance is recommended.

2. Action is in hand with a view to incorporating the required amount of tinfoil in the make-up of cartridges for all natures of guns, but, before it is clear to do so, certain investigations and trials have yet to be carried out to make certain that the presence of the foil within a charge can have no deleterious effect on the cordite under any conditions, and also to determine whether the foil must be situated close to the base of the projectile in order that it may be completely volatilised, and so act efficaciously. These trials will be carried out at the establishments on shore.

With Q.F. ammunition, no difficulty exists in introducing the foil into the charge as the foil can be made up with it and secured in the proper place.

With B.L. charges, however, the matter is complicated by nearly all of these being made up in portions, and it is desired to ascertain whether the foil acts efficiently if a proportion is worked into each cartridge or portion of the charge, so that, whatever charges are loaded into the gun, the right quantity of foil is introduced.

3. It is not practicable, on account of the great amount of labour entailed and consequent expense, to add the tinfoil as above to charges already made up, and therefore this method can only be adopted for new fillings.

It is accordingly recommended that, for practice firings and until cartridges made up with tinfoil are available, the following methods of introducing it should be adopted as far as practicable:—

(a) FOR B.L. GUNS.

The strips of foil should be stitched round the front end of the charge beforehand. It is important that the foil should be as far forward as possible when loaded into the gun.

This is considered to be much the most satisfactory method if it can be arranged.

Alternatively, there is no objection to the foil being thrown in immediately behind the projectile, but this is not recommended for the reasons already given, unless done with deliberation with consequent slight delay in loading.

Another alternative is to use a special clearing charge of double the usual amount of foil at every fourth round.

(b) FOR Q.F. GUNS WITH SEPARATE LOADING AMMUNITION.

Low Angle Guns.—A clearing charge of double the usual amount of foil should be thrown in after the projectile after every fourth or fifth round.

Slight delay in loading will be entailed in consequence.

High Angle Guns.—Use to be discontinued until cartridges with the foil embodied are supplied. If guns are badly coppered a round or two with clearing charge (double the usual amount) should be fired when convenient.

(c) FOR Q.F. GUNS WITH FIXED AMMUNITION.

The provision of rounds into which tinfoil has been incorporated must be awaited.

Notes :—

I.—For the correct amounts of foil to be used *see* table below.

II.—It is essential that, in all cases where the foil is thrown in, it should be crumpled very loosely.

III.—Experience points to coppering being just as bad with reduced as with full charges.

Table of Quantities of Tinfoil to be used.*

Gun.	When used every round.	When used as a clearing charge every fourth round.
	oz.	oz.
15-inch, B.L. -	8	16
13·5-inch, B.L.	7	14
12-inch, B.L. -	6	12
7·5-inch, B.L. -	2	4
6 and 5·5-inch, B.L.	1½	3
4·7-inch, B.L. -	1	2
4-inch, B.L. -	1½	3
4-inch, Q.F. -	½	1

* Note.—This table does not apply to Gunnery School tenders where special reduced charges are used and as to which separate instructions have been given.

Trials with tinfoil are in progress (1922), and further instructions will be issued in due course.

APPENDIX II.

Smoke Floats.

Type F. 3 Red consists of a sheet steel container of the shape shown in Figure 1; it is 2 feet in diameter and 2 feet in height, and weighs, when charged ready for use, about 120 lbs.

The cylinder B, forming the central portion of the float, contains the charge and is hermetically sealed by the makers after charging.

Igniters for use with the apparatus are supplied in a separate box containing 12, and instructions for use are pasted inside the lid of the igniter box.

To prepare the floats for use.—Remove the plug C (Figure 1) from the cover and screw in the igniter (Figure II).

To make smoke.—Remove the bayonet-jointed lid G of the igniter and scratch the friction priming K with the phosphorus tab H, found inside the lid. Allow the igniter to burn out and the smoke mixture to get well under way before throwing the float overboard. If this precaution be not observed frequent failures will result as unless the smoke mixture itself is well alight it will be extinguished on contact with the water. Once it is well alight, however, it cannot be extinguished even if submerged.

On ignition the smoke issues from the igniter boss, from which the igniter is blown out and from the vents E in the cover, the sealing of which is melted as soon as the charge becomes ignited.

If necessary, F. 3 Red Smoke Floats may be burnt on board and in this case they should be placed on an iron platform or deck in a position well removed from any inflammable material.

F. 3 Red Smoke Floats are the only type of smoke apparatus at present in use in the Service, but new and improved types are being developed, including a chlorosulphonic acid sprayer.

F. 5 Blue Smoke Floats have been declared obsolete on account of their liability to spontaneous combustion, and any still on board H.M. Ships have been ordered to be dumped, and those in store in the dockyards are to be emptied and refilled with the F. 3 Red type of mixture as opportunity occurs.

Smoke Floats are never to be stowed between decks, and care must be taken to avoid damage to floats through rough usage, as the smoke mixture deteriorates rapidly on contact with water. If sufficient water enters the container considerable heating takes place, but if the float is kept properly sealed there is no danger from the heating of the mixture and it should not deteriorate appreciably even after prolonged storage.

Boxes of igniters should be stowed in the Firework Box. Further details as to Smoke Floats and igniters will be found in C.B. 1515 (25). The Technical History and Index (T.H. 25).

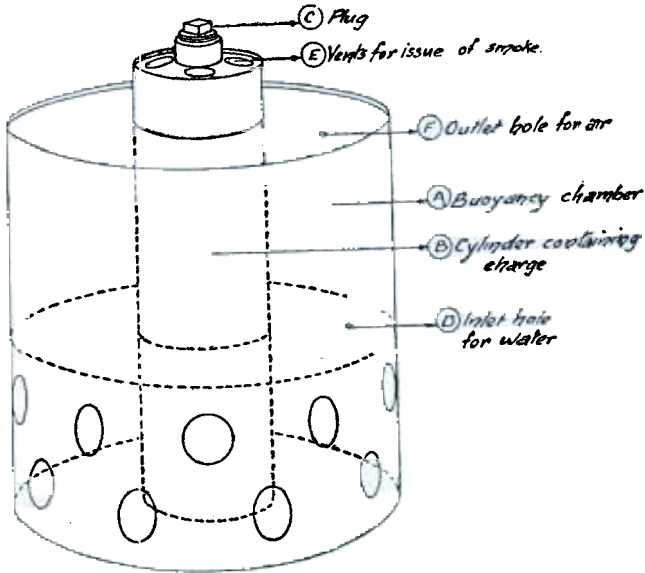

FIG. 1.

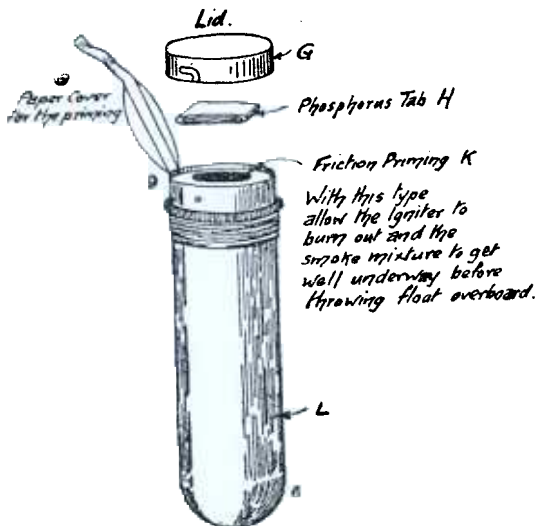

FIG. 2.

INDEX.

	PAGE
Access doors	133
Accidents	vi
Acetone	8
Adapters for Q.F. cartridges	30
Adapters for shells	65, 67
Aiming rifle ammunition, 1-inch	111
Aiming tube cartridges	115
Amatol	5
Ammonium picrate	4
Appearance of corroded cordite	11
Aprons, shell room	135
Armour, piercing of	63
A.	
Backflash	13
Bags, silk cloth for B.L. cartridges	18
Ballistic caps	64
Blank cartridges for B.L. guns	49
" " for Q.F. guns	49
" " marking on	52
Bombs, stick (for guns)	118
Books and Forms used in connection with ammunition	145
Bores, of guns, decopperting	178
Boxes, Q.F. ammunition	58
" small arm ammunition	61
" 3- and 6-pdr.	41
" firework	129
Bursters of shell	64
B.	
Cap ballistic	64
" compositions	16
Caps, for shell	63
" " care required in handling and transport	77
" percussion	16
Cartridge, Q.F. Blank 4-inch Marks V and V* guns	49
" " " 12-pdr. 12-cwt.	50
" " " 12-pdr. 8-cwt.	50
" " " 6- and 3-pdr.	51
" Signal 1-inch	128
" " 1½-inch	128
Cartridges, B.L.	18
" Q.F.	26
" for stick bombs in guns	119
" marking of	20
Cases, cartridge Q.F.	26
" cylindrical	57
" fired	26
" metal-lined	59
" rectangular	56
" weakening of cordite cases	55
Centring discs in Q.F. cartridges	28
Chargers, .303-inch cartridge	113
C.	

	PAGE.
Clips, cartridge, Q.F.	27
CO ₂ machines	141
Composition, exploding or C.E.	7
" R.D. No. 202 (fuze powder)	85
Cooling of magazines	139
Cordite, Mark I	8
" M.D.	9
" " backflash	13
" " chemical analysis	10
" " ignition	12
" " rate of burning	12
" " smoke developed by	13
" " stability and storage	13
" " sweating	12
" " system of proof	10
" " visual examination	11
" use of forms	9
" corroded	11
" cylinders for Q.F. igniters	30
Covers, silk cloth for B.L. igniters	18
Cups, leatherboard for wadding blank charges	49

D.

Decoppering (tin foil)	178
Demands	145
Dermatine	55
Detonators, disruptive	109
" for fuzes	109
" igniferous	109
Distance pieces in Q.F. cartridges	28
Drill tubes	48
Driving bands	73
Dummy tubes	48

E.

Expense book	145
Explosion, initiation of	15
Exudation from T.N.T. or amatol	6

F.

Fillings for shell	65
Fixed ammunition	29
Flap-type scuttle	134
Flash-proof scuttle	134
Flash, provisions against	133
Flasks CO ₂ , storage of	143
Floats, smoke	179
Flooding arrangements	136
Foreword	vi
Forms used with cordite	148
Fulminate of mercury	15
Fuze covers	90
" powders (time compositions)	85
" hydrostatic No. 8	106
" percussion base Hotchkiss, Mark IV	93
" " " large No. 16	100
" " " " No. 16D	101
" " " " medium, No. 12	94

	PAGE.
Fuze, T. and P. No. 81 - - - - -	101
" " No. 84 - - - - -	84
" " No. 92 (or 192) - - - - -	101
" time, No. 181 - - - - -	101
" " No. 185 - - - - -	105
" " No. 192 (or 92) - - - - -	101
" detonators for - - - - -	92
" failures, blinds and prematures - - - - -	90
" graze - - - - -	82
" hydrostatic - - - - -	90
" percussion - - - - -	81
" time - - - - -	84
" time and percussion - - - - -	84

G.

Gainé No. 2 - - - - -	108
Gaines - - - - -	92
Gauges, projectile - - - - -	76
Grabs - - - - -	77
Grenade ·303-inch rifle No. 32 night signal - - - - -	126
" " No. 31 day signal - - - - -	127
Grenades - - - - -	126
Gunpowder - - - - -	13

H.

Hang fires (Q.F. guns) - - - - -	29
High explosive shell - - - - -	68

I.

Igniters, B.L. charges - - - - -	18
" marking of, for B.L. cartridges - - - - -	21
" Q.F. cartridges - - - - -	30
Igniting pellets - - - - -	86
Illuminating compositions - - - - -	16
Initiating explosives - - - - -	15
Issues, returns and - - - - -	146

K.

Keys and tools for use with Q.F. cartridges - - - - -	32
Kit plasters - - - - -	90

L.

Labels, ammunition packages and mines - - - - -	22
" B.L. cartridge case - - - - -	23
" Q.F. cartridge lids - - - - -	41
Lids, Q.F., cartridge - - - - -	27
" " marking on - - - - -	38
" " precautions before firing - - - - -	29
Lifebuoys, night - - - - -	131
Light, coastguard - - - - -	124
" long - - - - -	124
" short - - - - -	125
Luck scuttle - - - - -	135
Luting - - - - -	54
Lyddite - - - - -	3

	M.	PAGE.
Markings on adapters		37
" ammunition boxes		39
" B.L. cartridges		20
" bomb cartridges		120
" bombs		120
" boxes for Q.F. cartridges		39
" " 3- and 6-pdr. cartridges		41
" cases for B.L. cartridges		21
" Q.F. cartridge cases		34
" igniters		21
" lids Q.F. ammunition boxes		39
" lids Q.F. cartridges		38
" percussion primers		37
" projectiles (and stampings)		78
" Q.F. ammunition		34
" S.A. ammunition		116
" tubes		48
Missfires (Q.F. cartridge lids)		29

N.

NH ₂ machines	141
Night tracers	72

O.

Ordnance ledger	145
" Stores	145
" Warrant	145

P.

Packing of B.L. cartridges	20
" Q.F. ammunition	34
" S.A. " "	116
" tubes	48
Picric powder	4
Portfire	125
Prematures (shells or fuzes)	91
Primer, percussion No. 1 Mark II	30
" " No. 2 Mark III	32
" " No. 2 Mark IV	31
" " No. 2 Mark V	32
" " No. 2 Mark VI	32
" " No. 5 Mark I	32
Projectile gauges	76
Projectiles, cracking of	65
" (general)	63
" marking of	78
" practice	72
" transport of	77
Propellants	8

Q.

Quick-match	126
-------------	-----

R.

R.D. composition No. 202	- - - -	85
Returns and issues	- - - -	146
Revolver ammunition	- - - -	114
Rocket, Light and Sound, 1-lb., Mark I	- - - -	122
" Signal, 1-lb., Red, Blue, and Green, Mark II	- - - -	122
" " $\frac{1}{2}$ -lb., Red, Blue, and Green, Mark II	- - - -	122
" " 1-lb., Service, Mark III	- - - -	121
" Sound, $\frac{1}{2}$ -lb., Mark II	- - - -	122

S.

S.A. ammunition, .303-inch	- - - -	112
S.A.A. boxes	- - - -	61
" marking of	- - - -	116
Safety fuze	- - - -	126
Saltpetre (<i>see</i> Gunpowder)	- - - -	13
Saluting ships	- - - -	49
Scuttles, flash proof	- - - -	134
Separate ammunition	- - - -	30
Shell A.P.C.	- - - -	66
" " liability to crack	- - - -	66
" C.P.	- - - -	66
" C.P.C.	- - - -	65
" " liability to crack	- - - -	65
" H.E.	- - - -	68
" lyddite, common	- - - -	68
" Precautions in handling	- - - -	77
" semi A.P.	- - - -	67
" shrapnel	- - - -	69
" smoke	- - - -	72
" star	- - - -	71
" target smoke	- - - -	72
" T.N.T. common shell (nose fuze)	- - - -	69
" room aprons	- - - -	135
Shot practice	- - - -	72
Signal compositions	- - - -	16
Silk cloth for B.L. charges	- - - -	18
" " covers for B.L. igniters	- - - -	18
Slings	- - - -	77
Slow match	- - - -	126
Smoke composition	- - - -	128
" floats	- - - -	179
" of cordite	- - - -	13
" signals	- - - -	128
Socket signal: light and sound	- - - -	129
Spraying arrangements	- - - -	138
Star composition	- - - -	127
" shell	- - - -	71
Stick bombs	- - - -	118
Sticks for bombs	- - - -	119

T.

Tables	- - - -	155
Temperature tubes	- - - -	144
Tinfoil (decoppering)	- - - -	178
Tracers, night	- - - -	72
Trinitrotoluene (T.N.T. or trotyl)	- - - -	5

	PAGE.
Tube, V.S. electric "S" large, Mark I -	44
" " " large, Mark IV -	45
" " " "P" Mark VI -	46
" " percussion, large, Mark II -	46
" " " Mark VII -	47
Tubes, drill -	48
" dummy -	48
" for testing circuits -	47
" friction -	123
" identification -	48
" large -	44
" small -	46
" S.A.A. cartridge -	48

V.

Ventilation arrangements -	139
Venting magazines, importance of -	135
Very's light (signal cartridge) -	128

W.

Wads, felt, in Q.F. cartridges	28
" in Blank charges -	49
Waterproofing of time fuzes -	89